

合格证
QC PASS

Godox

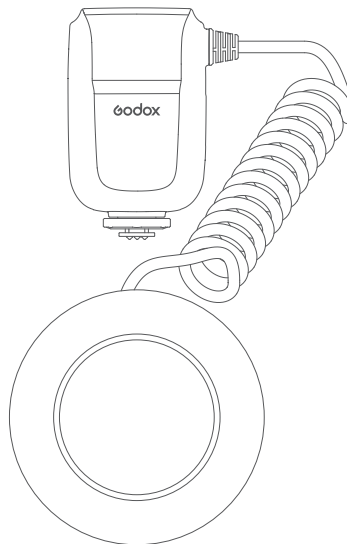

Wechat
Official Account
神牛微信公众号

深圳市神牛摄影器材有限公司

地址: 深圳市宝安区福海街道塘尾社区耀川工业区厂房2栋 电话: 0755-29609320(8062)

传真: 0755-25723423 邮箱: godox@godox.com

GODOX Photo Equipment Co.,Ltd.

Add: Building 2, Yaochuan Industrial Zone, Tangwei Community, Fuhai Street, Bao'an District,
Shenzhen 518103, China Tel: +86-755-29609320(8062) Fax: +86-755-25723423

E-mail: godox@godox.com

godox.com

Made in China | 705-MFR76C-04



MF-R76C

TTL 微距环形闪光灯
TTL Macro Ring Flash

使用手册
Instruction Manual

前言

感谢您购买神牛产品。

TTL 微距闪光灯 MF-R76C 适用于佳能相机,兼容 E-TTL II 自动闪光。该机拥有 2.4G 无线发射和接收、2 种闪光输出模式、超多档功率调节等诸多特性; 适用于昆虫摄影、植物摄影、珠宝摄影、口腔牙科摄影等微距拍摄场景。

主要特点

- 接近拍摄时机身不会遮挡闪光灯的灯光, 闪光无暗角无阴影
- 多档位精准控制, 可在 1/1 全功率 -1/256 功率间以 1/3EV 调节
- 兼备 2.4G 无线发射和接收, 无线闪光中可当主控灯可当从属灯
- 锂电池供电, 超长续航, 1/1 全功率闪光次数多达 550 次
- 灯体安装方便, 灵活性高, 适用于 49mm-77mm 口径相机镜头
- 2 个对焦辅助灯, 10 档亮度调节, 在黑暗环境下更容易对焦
- 极简用户界面, 操作轻松便捷

主要特点

- ▲ 请保持干燥。
- ▲ 请勿私自拆卸产品, 如产品出现故障须由本公司或授权的维修人员进行检查维修。
- ▲ 请勿让儿童接触本产品。
- ▲ 禁止拆卸、撞击、挤压或投入火中, 若出现严重鼓胀, 请勿继续使用。请勿放置在超过 50 度的高温环境中。
- ▲ 请勿将闪光灯头正对人眼闪光(特别是婴儿的眼睛), 否则可能会在短时间内造成视力障碍。
- ▲ 请勿在化学品、可燃性气体或其他特殊物质附近使用闪光灯, 这些物质在特殊情况下可能对闪光灯发出的瞬间强光敏感, 有可能导致火灾或电磁干扰。在这些场合下, 请注意相关警告标识。
- ▲ 本产品不能防水, 在雨天及潮湿环境下请注意防水。

部件名称

灯体

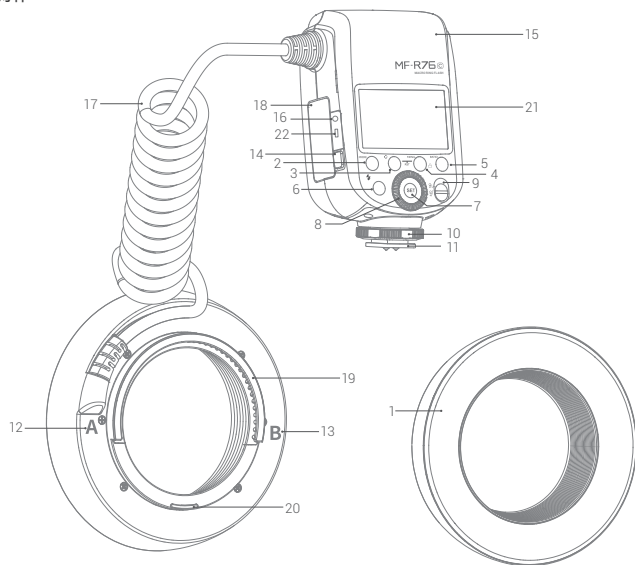

- 01. 灯头
- 02. MODE 按键
- 03. 对焦辅助灯按键(1~10调节)
- 04. MENU/锁定按键
- 05. RATIO 按键
- 06. 引闪按键
- 07. SET 按键
- 08. 调节拨轮
- 09. 开关拨钮
- 10. 锁定环
- 11. 热靴

- 12. 闪光管 A
- 13. 闪光管 B
- 14. 取电池按钮
- 15. 控制器主体
- 16. 2.5mm 同步插孔
- 17. 连接线
- 18. 锂电池
- 19. 镜头适配环连接口
- 20. 拆卸卡口
- 21. 显示屏
- 22. Type-C 接口

显示屏

ETTL 自动闪光模式

ETTL: E TTL自动闪光

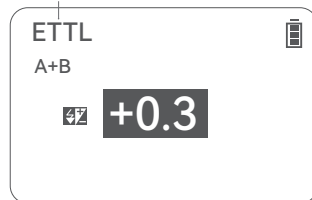

M(手动)闪光模式

M(手动闪光)

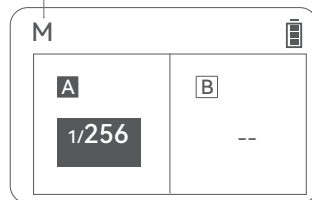

2.4G无线传输, 作为主控灯

- A: 闪光组 A
- B: 闪光组 B
- C: 闪光组 C
- D: 闪光组 D

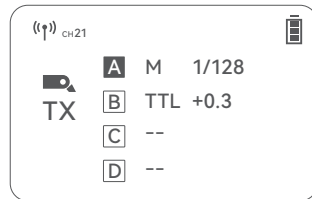

2.4G无线传输, 作为从属灯

RX: 从属闪光组 (可选A或B或C或D)

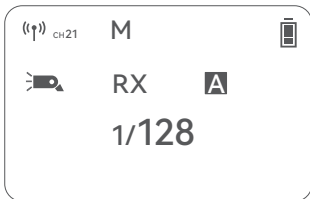

包装清单

TTL 微距环形
闪光灯 ×1

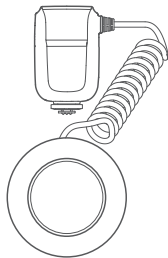

镜头适配环套装 AR-R Kit ×1



锂电池 ×1



USB 充电座 ×1



Type-C-USB 充电线 ×1

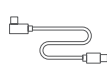

收纳袋 ×1



电池

1. 本品采用 7.2V/2980mAh 锂电池, 使用寿命长。
2. 安全可靠, 内置电路有过充保护、过放保护、过流保护、短路保护。

小提示: 微距环形闪光灯 MF-R76C 通用神牛 V1 锂电池 VB26 和神牛 AD100Pro 锂电池 WB100。

注意事项

1. 避免正负极短路。
2. 电池没有防水功能, 不要把电池浸泡在雾、水中。
3. 放置于儿童不易接触地方。
4. 电池充电不要放置超过 24 小时。
5. 电池应放置于凉爽、干燥及通风地方存储。
6. 电池不要靠近或放置于火中。
7. 电池使用报废后请按当地的规定处理。
8. 如果电池超过 3 个月不使用, 请对电池进行满电充电。
9. 长期不使用, 请充电至 60% 左右再放置。

装/卸电池

1. 拆卸电池

用您的手指长按电池按钮, 手往下推动电池, 便可取出电池。

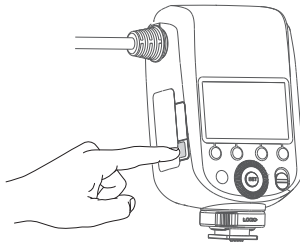

2. 安装电池

按照电池指示方向将锂电池插入电池仓, 直至扣件卡住即可。

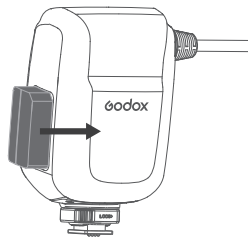

安装控制器

1. 滑动控制器热靴使其完全插入相机热靴插座中。

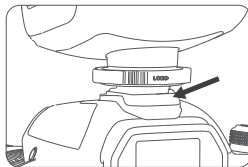

2. 拧紧锁定环: 按照逆时针方向旋转拧紧锁定环。

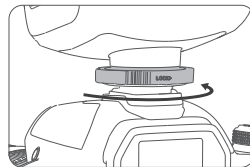

取下控制器

1. 松开锁定环

按住按钮，按照顺时针方向旋转松开锁定环，将控制器从相机热靴中取下。

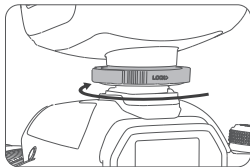

安装环形闪光灯

1. 将合适的镜头适配环，按照顺时针方向旋转安装到相机镜头前。

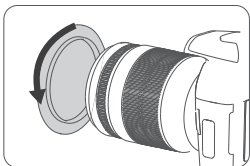

小提示：本产品配有 8 种规格的适配环，与相机镜头颈圈相符：49mm、52mm、55mm、58mm、62mm、67mm、72mm 和 77mm。

2. 将装有适配环的相机镜头对准适配环连接接口，轻轻卡上即可。

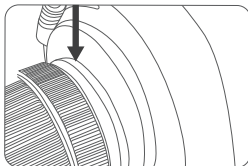

注：装好的环形灯可以360°旋转，属于正常安装情况

取下环形闪光灯

找到环形灯背面的拆卸卡口，用手稍微用力向上提拉的同时，往右轻轻旋转，环形闪光灯随之脱离镜头。

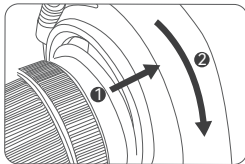

开机/关机

将开关拨钮拨至<ON>，即为开机；拨至<OFF>，即为关机。

ETTL闪光模式

短按 <MODE> 按键切换模式，切换至 <ETTL > 模式时，显示屏左上角显示 <ETTL >。

提示：ETTL 闪光会在快门释放前的瞬间进行一次预闪，闪光灯接收相机信息进行主闪光。

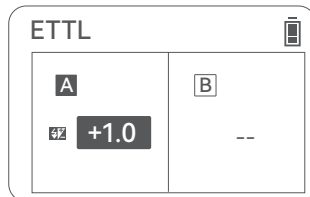

1. 设置整体闪光

短按 Ratio 按键令屏幕显示 <ETTL> 和 <R2> 曝光补偿值 (-3~+3)。

旋转调节拨轮即可设置曝光补偿值，可以在 +3 档间以 1/3 档为增量设置。



2. 设置A:B闪光光比

调整闪光灯A和闪光灯B之间的闪光光比，以产生不同场景下的明暗比。

1. 短按 Ratio 按键令屏幕显示 <A:B> 和 <8:1-4:1-2:1-1:1-1:2-1:4-1:8>。



- 短按SET按键可选-**4/7**-曝光补偿值/A:B闪光光比值,选中后旋转调节拨轮即可设置曝光补偿值/A:B闪光光比。设置曝光补偿值,可以在+3档间以1/3档为增量设置。设置A:B闪光光比,可在8:1-1:8闪光光比间以1/2档为增量设置。

A:B闪光比范围: 8:1 - 5.6:1 - 4:1 - 2.8:1 - 2:1 - 1.4:1 - 1:1 - 1:1.4 - 1:2 - 1:2.8 - 1:4 - 1:5.6 - 1:8



设置单侧闪光 (A组闪光或B组闪光)

- 短按Ratio按键令屏幕显示<A B>和**4/7**曝光补偿值(-3~+3)。

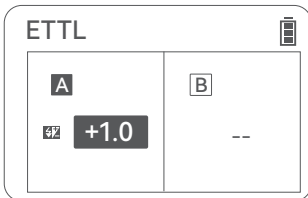

- 短按SET按键可选闪光灯管A单侧闪光/闪光灯管B单侧闪光,选中后旋转调节拨轮即可设置曝光补偿值,可以在+3档间以1/3档为增量设置。

- 注
- 闪光曝光补偿中“0.3”表示1/3档,“0.7”表示2/3档。
 - 想要取消闪光曝光补偿,将补偿量设回到“±0”即可。

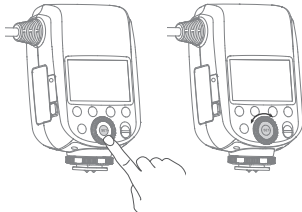

M(手动)闪光模式

短按MODE按键切换模式,切换至<M>手动闪光模式时,显示屏左上角显示<M>。

闪光灯拥有三种方式闪光: 闪光管A和闪光管B以不同功率闪光、只有闪光管A或闪光管B闪光、闪光管A和闪光管B以相同功率闪光。

1. 设置整体闪光功率

短按Ratio按键令屏幕显示<M>和输出功率。

旋转调节拨轮即可设置输出功率,可在1/1全功率至1/256功率间以1/3档为增量设置。

注: 开启高速同步时,最小功率为1/64。



2. 设置A:B闪光功率

短按Ratio按键令屏幕显示<A B>和两处输出功率。

短按SET按键可选A组功率/B组功率,选中后旋转调节拨轮即可设置A组功率/B组功率;可在1/1全功率至1/256功率间以1/3档为增量设置。

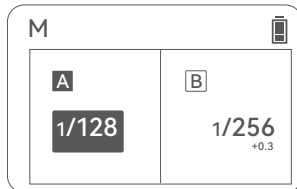

3. 设置单侧闪光功率

短按Ratio按键令屏幕显示<A B>和单侧输出功率。

短按SET按键可选A组功率/B组功率,选中后旋转调节拨轮即可设置A组功率/B组功率;可在1/1全功率至1/256功率间以1/3档为增量设置。

注: 如A组输出闪光, B组为关闭状态。

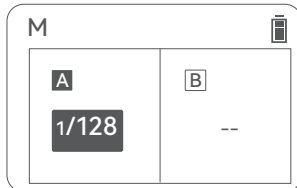

主控灯界面设置

进入菜单,将闪光灯状态设置为无线主控(具体操作查看无线设置章节)。

拨动调节拨轮可选A组/B组/C组/D组,短按SET按键选中A组/B组/C组/D组,短按MODE按键可切换至TTL/M/--,当切换至TTL,旋转调节拨轮调节闪光曝光补偿值,可在+3之间以1/3档为增量设置闪光曝光补偿值。当切换至M旋转调节拨轮可在1/1全功率至1/256功率间以1/3档为增量设置功率。

注: TTL表示TTL自动闪光, M表示手动闪光, --表示关闭。界面中A、B、C、D参数值分别为被控制的从属灯A、从属灯B、从属灯C、从属灯D参数值。一台主控灯最多控制四台从属灯。主控灯闪光输出值为A组闪光输出值。

主控灯的无线频道需设置和从属灯一致,方可控制从属灯,具体操作查看无线设置章节。

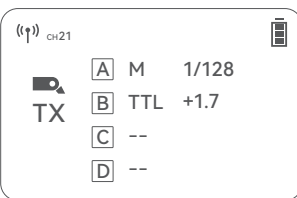

从属灯界面设置

进入菜单，将闪光灯状态设置为无线从属（具体操作查看下方无线设置章节）。

短按SET按键或旋转调节拨轮可切换至A/B/C/D。
切换至A，表示该灯设置为从属灯A。
切换至B，表示该灯设置为从属灯B。
切换至C，表示该灯设置为从属灯C。
切换至D，表示该灯设置为从属灯D。

注：从属灯的无线频道需设置和主控灯的频道一致，具体操作查看无线设置章节。

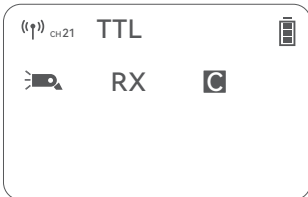
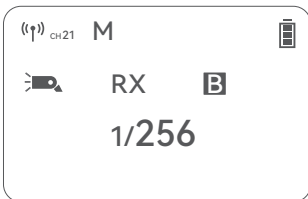

无线设置

1. 设置闪光灯为主控灯

短按MENU/锁定按键进入菜单，旋转调节拨轮至<WIRELESS>，短按SET按键进入界面，旋转调节拨轮选中<TX>，设置完毕，短按SET按键返回上一级。

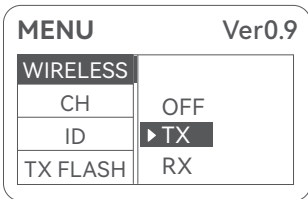

2. 设置闪光灯为从属灯

短按MENU/锁定按键进入菜单，旋转调节拨轮至<WIRELESS>，短按SET按键进入界面，旋转调节拨轮选中<RX>，设置完毕，短按SET按键返回上一级。

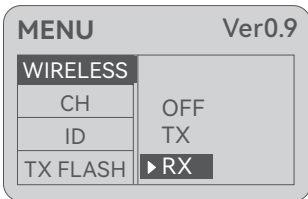

3. 设置主控闪光灯闪光

短按MENU/锁定按键进入菜单，旋转调节拨轮至<TX FLASH>，短按SET按键进入界面，旋转调节拨轮选<☑️>或<☒️>。
选<☑️>：主控闪光灯闪光关闭，即该灯作为主控灯时，在无线闪光拍摄中不闪光。
选<☒️>：主控闪光灯闪光开启，即该灯作为主控灯时，在无线闪光拍摄中正常闪光。

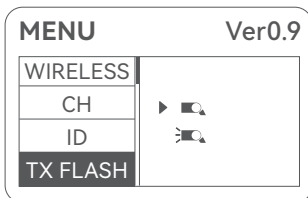

4. 设置无线频道

短按MENU/锁定按键进入菜单，旋转调节拨轮至<CH>，短按SET按键进入设置界面，旋转调节拨轮可选01-32，设置完毕，短按SET按键返回上一级。

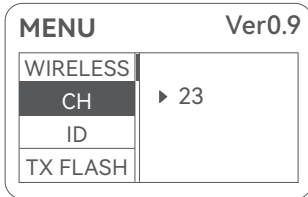

5. 设置无线ID

短按MENU/锁定按键进入菜单，旋转调节拨轮至<ID>，短按SET按键进入设置界面，旋转调节拨轮可选OFF/01-99，设置完毕，短按SET按键返回上一级。

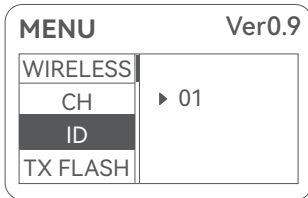

无线多重闪光拍摄(无线2.4G输出)

本章主要说明如何以闪光灯MF-R76C为主控，搭配具备2.4G无线接收功能闪光灯（如神牛MF-R76C、神牛AD100PRO、神牛V860III等闪光灯），以2.4G无线传输的方式进行无线多重闪光拍摄。本章将安装在相机上的MF-R76C称为“主控灯”，受无线控制的闪光灯（如神牛MF-R76C、神牛AD100PRO、神牛V860III等闪光灯）称为“从属灯”。

1. TTL：使用TTL自动闪光输出的无线多重闪光拍摄

只要将MF-R76C（主控灯）闪光组（A、B、C、D）均设置为<TTL>，不需要操作从属灯；从属灯A/B/C/D自动闪光进行无线多重闪光拍摄。在主控灯上设置的曝光补偿值，不需要手动设置从属灯，从属灯也会跟随主控灯自动设置。

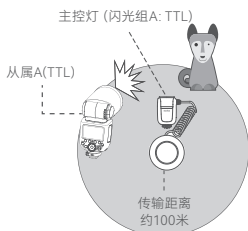

使用一个从属灯进行自动闪光拍摄

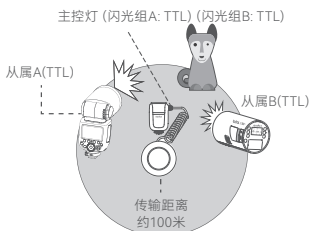

使用两个从属灯进行自动闪光拍摄

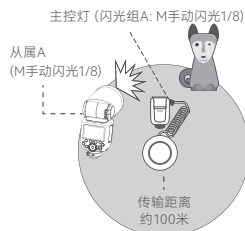

使用一个从属灯进行无线闪光拍摄

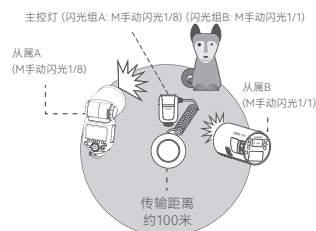

使用两个从属灯进行无线闪光拍摄

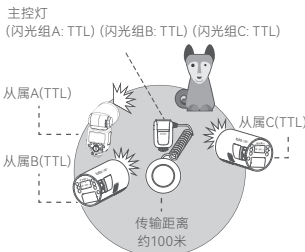

使用三个从属灯进行自动闪光拍摄

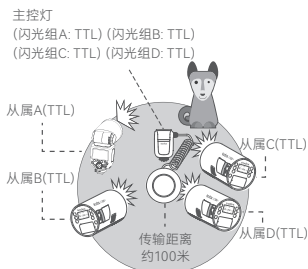

使用四个从属灯进行自动闪光拍摄

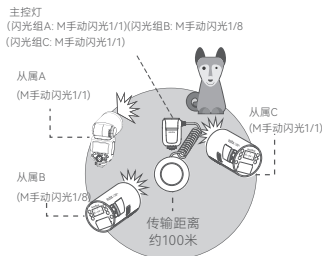

使用三个从属灯进行无线闪光拍摄

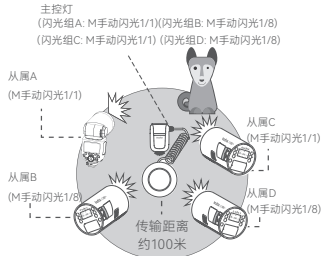

使用四个从属灯进行无线闪光拍摄

2. M: 使用M手动闪光输出的无线多重闪光拍摄

MF-R76C (主控灯) 闪光组 (A、B、C、D) 可设置为统一闪光输出功率, 也可以设置为不同闪光输出功率, 与上面操作同理, 不需要手动设置从属灯; 从属灯A/B/C/D跟随主控灯自动设置闪光输出功率进行无线多重闪光拍摄。

3. 不同闪光模式输出的无线多重闪光拍摄

MF-R76C (主控灯) 闪光组 (A、B、C、D) 可设置成不同的闪光模式, 不需要操作从属灯, 从属灯A/B/C/D自动以不同的闪光模式进行无线多重闪光拍摄。在主控灯上设置的曝光补偿值, 不需要手动设置从属灯, 从属灯也会跟随主控灯自动设置。

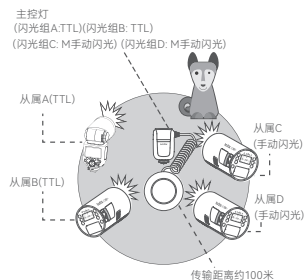

注

1. 当相机的拍摄模式设为全自动模式或程序影像控制区模式时，无法利用本章中的操作。将相机的拍摄模式设为P/Tv/Av/M/B(创意拍摄区模式)，才能操作无线闪光。
2. 本章中举例的从属灯皆属另购。
3. 主控闪光灯闪光输出默认设为闪光组A
4. 如果主控灯和从属灯的频道设置不一致，从属灯不闪光，请务必将主控灯和从属灯的频道设成一样。从属灯如何设置频道请参考从属灯的使用说明书。
5. 为了避免干扰，请勿在主控灯和从属灯之间设置障碍物。
6. 开始无线多重闪光拍摄前，请进行测试闪光和试拍。
7. 如何将闪光灯设置为主控灯状态，参考无线设置章节或菜单设置。
8. 如何将闪光灯设置为从属灯状态，参考无线设置章节或菜单设置。
9. 上述章节说明均默认MF-R76C作为主控灯。

高速同步

MF-R76C能够产生与相机快门最大速度同步的高速闪光，想要在背景柔和时对准主体拍照，此功能尤为方便。

1. 短按MENU/锁定按键进入菜单设置
2. 旋转调节拨轮至<SYNC>
3. 短按SET按键进入设置界面
4. 旋转调节拨轮选中<H>
5. 短按MENU/锁定按键返回主界面，此时右上角显示<H>

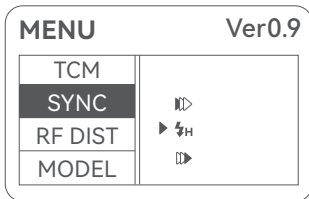

注：开启高速同步后，M（手动）闪光设置最小功率为1/64。



前帘同步

前帘闪光，是指当前帘完全打开后的一瞬间，闪光灯启动闪光，此功能适合一般情况的拍摄场景。

1. 短按MENU/锁定按键进入菜单设置
2. 旋转调节拨轮至<SYNC>
3. 短按SET按键进入设置界面
4. 旋转调节拨轮选中<H>
5. 短按MENU/锁定按键可返回主界面

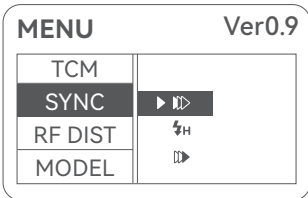

后帘同步

后帘闪光，是指当快门完全开启时不闪光，当后帘关闭前的一瞬间进行闪光，一般在慢速快门下使用此功能。

1. 短按MENU/锁定按键进入菜单设置
2. 旋转调节拨轮至<SYNC>
3. 短按SET按键进入设置界面
4. 旋转调节拨轮选中<H>
5. 短按MENU/锁定按键可返回主界面，此时右上角显示<H>

注：在无线多重闪光拍摄（无线主控/无线从属）中，不能设置后帘同步。



对焦辅助灯设置

短按对焦辅助灯按键，实现开启或关闭对焦辅助灯。

对焦辅助灯调节：开启对焦辅助灯后，长按对焦辅助灯按键进入对焦辅助灯调节界面，旋转调节拨轮进行01-10级调节。设置完毕，长按对焦辅助灯按键退出对焦辅助灯调节界面。

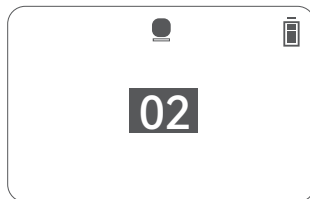

锁定功能

长按MENU/锁定按键，实现锁定当前界面或解锁当前界面。

锁定界面时，短按任意按键无反应，以防拍摄中误调。

注：进入菜单界面后，长按MENU/锁定按键无反应，不起锁定作用。

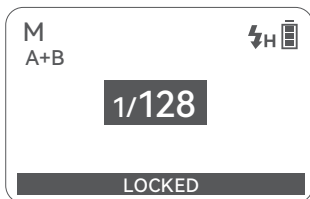

同步插孔触发

同步插孔规格为φ2.5mm，此处可插入同步线或者触发器触发插头对闪光灯进行同步引闪。

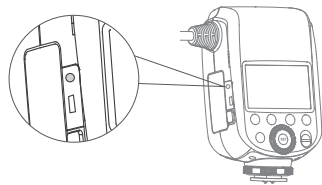

过热保护功能

为防止闪光灯过热并损坏,请勿在1/1档位时进行超过30次的快速连续闪光。30次连续闪光后,要让闪光灯至少冷却10分钟。

您在进行超过30次连续闪光后马上继续进行更多次闪光,内部的过热保护功能可能会被激活,过热保护功能启动后,显示屏右上角显示<>。如果发生这种现象,请让闪光灯冷却约10分钟,闪光灯便会恢复正常。

激活过热保护功能的连续闪光次数

档位	连续闪光次数
1/1	60
1/2	80
1/4	150
1/8	200
1/16	340
1/32	540
1/64	1000
1/128	1000
1/256	1000

高速同步模式下,激活过热保护功能的连续闪光次数

档位	连续闪光次数
1/1	30
1/2	30
1/4	35
1/8	40
1/16	50
1/32	50
1/64	60

其他保护



显示屏显示	警示内容
E0	设备内部温度传感器有问题,请维修。
E1	闪光灯回电系统出现问题,无法回电引闪,请重新开机,如无法解决请维修。
E2	设备内温度过高,请停止引闪10分钟。
E3	闪光灯两端电压过高,请维修。

灯体重置

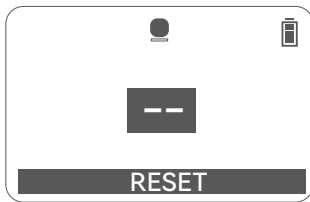
同时长按对焦辅助灯按键和MUEU按键直至“RESET”出现,“RESET”消失则表示重置完毕。



菜单设置

一级选项	二级选项	说明
WIRELESS(无线)	OFF	关闭无线
	TX	开启主控无线
	RX	开启从属无线
CH(频道)	01-32	32个频道选择
ID(识别号)	OFF	关闭ID
	01-99	99个ID号选择
TX FLASH(主控闪光)		作为主控灯使用时,关闭主控灯闪光
		作为主控灯使用时,开启主控灯闪光
TCM (TTL拍摄值转M值)	OFF	关闭
	ON	开启(TCM在菜单开启后,短按MODE按键可以进行TCM转换,此功能不支持无线闪光或单侧闪光使用)
SYNC(同步)		前帘同步
		高速同步
RF DIST(引闪距离)		WIRELESS(无线)处于OFF时,显示屏才显示后帘同步此选项
	0.3-10m	引闪距离:0.3-10m
MODEL(模式)	1-100m	引闪距离:1-100m
		CONT 开启造型灯后,闪光灯闪光时,造型灯不会熄灭
STBY(主控睡眠)		INTER 开启造型灯后,闪光灯闪光时,造型灯熄灭
	ON	作为主控灯使用时,开启休眠
RX STBY(从属睡眠)	OFF	作为主控灯使用时,关闭休眠
	60 mins	作为从属灯使用时,超过60分钟无人操作,进入休眠
	30 mins	作为从属灯使用时,超过30分钟无人操作,进入休眠
BL(背光)	OFF	作为从属灯使用时,关闭休眠
	12 secs	作为从属灯使用时,超过12秒无人操作,背光自动熄灭
	>12 secs	>12秒无人操作,背光自动熄灭
LCD(显示屏对比度)	OFF	闪光灯背光处于熄灭状态
	ON	闪光灯背光一直亮着
LCD(显示屏对比度)	-3~+3	显示屏对比度,7个级别

规格参数

名称	TTL微距环形闪光灯
型号	MF-R76C
闪光指数	GN14(ISO 100, 以米为单位)
兼容相机	佳能
锂电池	7.2V/2980mAh
闪光灯功率 (1/1档位)	76Ws
闪光色温	5900K±200K
对焦辅助灯功率	0.7W*2
对焦辅助灯色温	5300K±200K
闪光档位	1/1~1/256(以1/3档为增量调节)
闪光持续时间	1/300s~1/20000s
闪光模式	TTL闪光、M手动闪光
曝光补偿	-3~+3 EV(曝光值), 以1/3 EV为增量调节
高速同步	具备
后帘同步	具备
前帘同步	具备
灯体内径	77mm
回电时间	0.1~1s
全功率闪光次数	550次
无线传输距离	0~100m
频道	32组: 01-32
ID号	99个: 01-99
工作环境温度	-10~50°C
环形闪光灯尺寸	130*130*27毫米/5.1*5.1*1英寸
控制器尺寸	120*70*50毫米/4.7*2.7*1.9英寸
净重 (含电池)	578克/20.39盎司

上述所有的规格均基于神牛测试标准; 设计和规格如有变更, 恕不另行通知。

兼容佳能相机列表

80D、90D、7D、6D、70D、750D/760D、5DMarkIV、EOS 1DX、6DMarkII、77D、800D、5DMarkIII、5DMarkIII、60D、7D Mark II、600D、50D、30D、500D、Digital X、M5、M50、R、RP、1500D、3000D

注: 1. 此表格仅列举目前已测试的相机型号, 未涵盖所有佳能相机。其他相机型号, 用户可自行测试。
2. 本公司保留未来修改此表格内容的权利。

故障排除指南

使用中遇到问题, 请参考此故障排除指南

问题	可能原因	解决办法
闪光灯不闪光	闪光灯没有正确安装	请将闪光灯热靴牢固地安装在相机上
	闪光灯和相机的电子触点脏	请将闪光灯和相机的电子触点清理干净
电源自动关闭	微距闪光灯作为主控灯时, 菜单STBY选择ON选项, >90秒无人操作, 电源自动关闭以节能	可按机身任意按键唤醒
	微距闪光灯作为从属灯时, 菜单RX STBY选择60mins或30mins选项, >60分钟或30分钟无人操作, 电源自动关闭以节能	可按机身任意按键唤醒
无法开机	电池没电或电池已损坏	请更换充满电的电池或新电池
作为从属灯时不闪光	从属灯设置的闪光组别不正确, 例如主控灯B组处于关闭状态, 而从属灯闪光灯组设置为B	正确设置从属灯的闪光组
	主控灯和从属灯设置的传输频道不一致	请将主控灯和从属灯设置传输频道设置一致, 例如主控灯频道为01, 从属灯频道也为01
	从属灯不在主控灯的无线传输范围内	请将从属灯设置在主控灯传输范围内, 无线传输范围为0~100m
	主控灯和从属灯过于靠近, 无法正常进行传输	请设置闪光灯的引闪距离; 在MENU-RF DIST中设置为0.3~10m。

固件升级

1. 本产品USB接口为Type-C接口, 请使用Type-C USB线 (另购)。
2. 产品升级固件需要Godox G3程序软件支持, 升级固件前请前往神牛官网<https://www.godox.com.cn>下载安装“Godox G3固件升级软件”, 再选择相应的固件文件。
3. 由于产品进行固件升级, 说明书请以最新电子版为准。

神牛2.4G无线漏闪原因及解决办法

1. 外部环境2.4G信号干扰(如无线路基、2.4Gwifi路由、蓝牙设备等)
→请调节闪光灯的频道CH设置(建议+10) 找到无干扰的频道, 或者在工作时关闭其他2.4G设备。
2. 请确认闪光灯是否已经回电或回电速度是否跟上连拍速度(闪光灯就绪指示灯已经亮起), 并且没有处于过热保护或者其他异常状态中。
→请下调闪光灯档位, 如是TTL模式可以尝试改为M模式(TTL模式下需要预闪一次)。
3. 是否主控灯和从属灯距离太近(距离<0.5m)
→请设置闪光灯引闪距离; 在MENU-RF DIST中设置为0.3~10m。
4. 是否闪光灯在低电状态
→请更换电池。

维修保养

闪光灯工作时, 如发现异常, 请立即关掉电源, 查明原因。
灯体应避免震动, 平时注意表面除尘。
灯体稍有发热为正常现象, 无特别需要时, 勿连续引闪。
闪光灯所有维修概由本厂指定可供原厂配件的维修部负责。
1年保修, 消耗品如灯管等, 不在1年保修范围。
经发现, 擅自检修此闪光灯的, 将取消闪光灯保修, 维修需收取相关费用。
如有技术更改, 恕不另行通知。

Forward

Thank you for purchasing!

MF-R76C is a macro ring flash suitable for Canon cameras and compatible with E-TTL II auto flash. Equipped with 2.4G wireless transmission, 2 flash modes and multiple output power adjustment, it can be widely used in macro shooting scenes such as insect photography, plant photography, jewelry photography and dental photography.

Main Features

- No vignetting and no shadows in macro shooting.
- Accurate power adjustment from 1/1 full power to 1/256 at 1/3EV each stop.
- Equipped with 2.4G wireless transmission, workable as a transmitter or receiver unit in wireless flash group.
- Lithium battery power supply, up to 550 flash times in 1/1 full power.
- Easy to install and suitable for camera lenses with a diameter of 49mm-77mm.
- 2 focus assist beams and 10 levels of brightness adjustment.
- Simple user's interface, convenient and comfortable operation.

Warning

- ▲ Always keep this product dry.
- ▲ Do not disassemble. Should repairs become necessary, this product must be sent to an authorized maintenance center.
- ▲ Keep out of reach of children.
- ▲ Stop using this product if it breaks open due to extrusion, falling or strong hit. Otherwise, electric shock may occur if you touch the electronic parts inside it.
- ▲ Do not leave or store the flash unit if the ambient temperature reads over 50°C.
- ▲ Do not fire the flash directly into the eyes (especially those of babies) within short distances. Otherwise visual impairment may occur.
- ▲ Do not use the flash unit in the presence of flammable gases, chemicals and other similar materials. In certain circumstance, these materials may be sensitive to the strong light emitting from this flash unit and fire or electromagnetic interference may result.
- ▲ As this product is not waterproof, do not use in rain or in damp conditions.

Name of Parts

Light Body

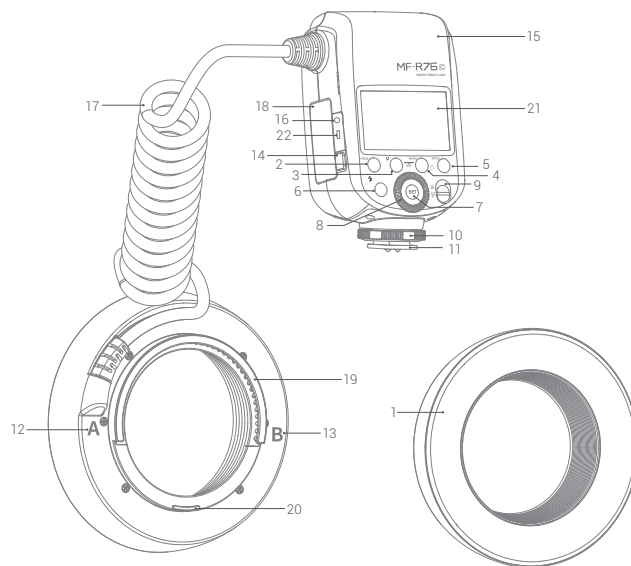

- | | |
|-------------------------------------------|----------------------------------|
| 01. Flash Head | 12. Flash Tube A |
| 02. MODE Button | 13. Flash Tube B |
| 03. Focus Assist Beam Button (1~10 level) | 14. Battery Remove Button |
| 04. MENU/Lock Button | 15. Controller |
| 05. RATIO Button | 16. 2.5mm Sync Cord Jack |
| 06. Test Button | 17. Connecting Cable |
| 07. SET Button | 18. Lithium Battery |
| 08. Select Dial | 19. Adapter Ring Connecting Port |
| 09. Power Switch Button | 20. Detaching Mount |
| 10. Lock Ring | 21. Display |
| 11. Hotshoe | 22. Type-C Port |

Display

ETTL Auto Flash Mode

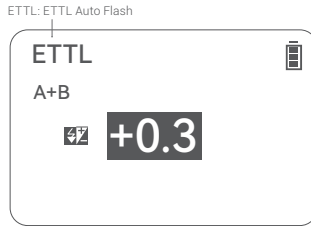

M (Manual) Flash Mode

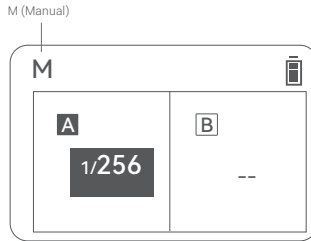

2.4G Wireless Transmission as a Transmitter Unit

- A: Flash Group A
- B: Flash Group B
- C: Flash Group C
- D: Flash Group D

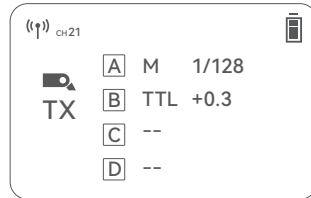

2.4G Wireless Transmission as a Receiver Unit
RX: Receiver Flash Group (A, B, C or D)

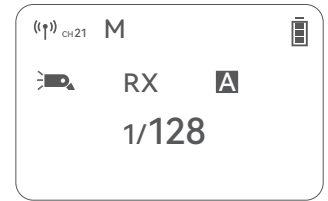

What's in the Box

TTL Macro Ring Flash x1

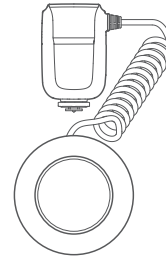

Adapter Rings Kit AR-R Kit x1



Lithium Battery x1



USB Charger x1



Type-C USB Charging Cable x1

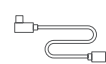

Storage Bag x1



Battery

1. This product uses 7.2V/2980mAh lithium battery which has long runtime.
2. It is reliably safe. The inner circuit is against overcharge, overdischarge, overcurrent, and short circuit.

Tips: Macro ring flash MF-R76C is compatible with Godox V1 lithium battery VB26 and AD100Pro lithium battery WB100.

Cautions

1. Do not short circuit.
2. Do not expose to rain or immerse into water. This battery is not water proof.
3. Keep out of reach of children.
4. No over 24 hours' continuous charging.
5. Store in dry, cool, ventilated places.
6. Do not put aside or into fire.
7. Dead batteries should be disposed according to local regulations.
8. If the battery had ceased using for over 3 months, please make a full recharge.
9. Please charge the battery to approx. 60% before being placed for long time.

Loading and Unloading the Battery

1. Unloading

Long press the battery remove button and push down the battery to unload it.

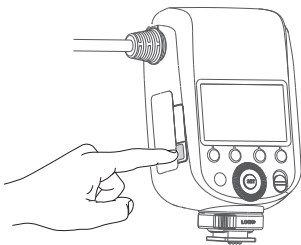

2. Loading

Insert the lithium battery according to the direction, push in until it is locked.

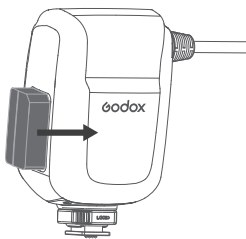

Installation of the Controller

1. Slide the hotshoe of the controller to completely insert it into the camera.

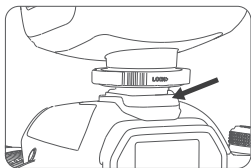

2. Tightening the lock ring:
Rotate anticlockwise to tighten the lock ring.

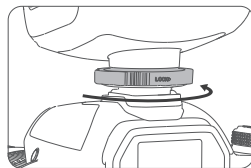

Disassembly of the Controller

1. Loosening the lock ring

Rotate clockwise to loosen the lock ring and take down the controller.

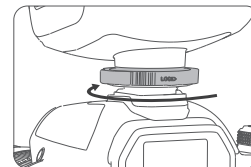

Installation of the ring flash

1. Rotate clockwise the proper adapter ring and mount it to the front of the lens.

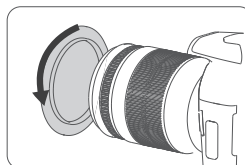

Tips: There are 8 adapter rings applicable to MF-R76C: 49mm, 52mm, 55mm, 58mm, 62mm, 67mm, 72mm and 77mm.

2. Insert the lens with adapter ring into the adapter ring connecting port until it is locked.

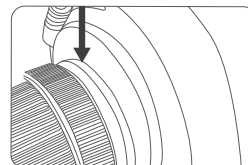

Note: It is normal that the mounted ring flash can be rotated 360°.

Disassembly of the ring flash

Slightly pull out the remove buckle on the back, and then rotate to the right to remove the ring flash.

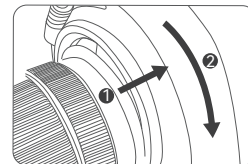

Power switch

Toggle Power switch button to <ON> to power on, and <OFF> to power off.

ETTL Flash Mode

Short press the <MODE> button to switch to <ETTL> mode, and the <ETTL> icon will be on the left upper corner of the display.

Note: When the shutter button is fully pressed, the E TTL flash will fire a pre-flash that the camera will use to calculate exposure and flash output the instant before the photo is taken.

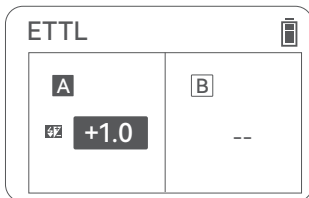

1. Overall Flash Setting

Short press the Ratio button to make <ETTL> icon and <F/2> >FEB value (-3~+3) on the display.



Turn the select dial to adjust the FEB value from -3 to +3 with an increment of 1/3 each stop.



2. A:B Flash Ratio Setting

Adjust the flash ratio of flash tube A to flash tube B, to achieve brightness to darkness ratio in different scenes.

Short press the Ratio button to make <A:B> icon and <8:1·4:1·2:1·1:1·1:2·1:4·1:8> on the display.

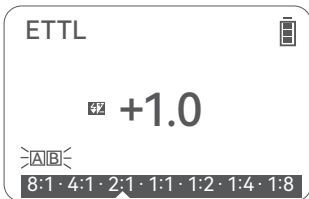

Short press the SET button to select <F/2> > FEB/A:B flash ratio, turn the select dial to adjust the FEB/A:B flash ratio. The FEB value is adjustable from -3 to +3 with an increment of 1/3 each stop, while A:B flash ratio is adjustable from 8:1 to 1:8 with an increment of 1/2 each stop (for example: 8:1 - 5.6:1 - 4:1 - 2.8:1 - 2:1 - 1.4:1 - 1:1 - 1:1.4 - 1:2 - 1:2.8 - 1:4 - 1:5.6 - 1:8).



3. Single Group (A or B) Flash Setting

Short press the Ratio button to make <A:B> icon and <F/2> > FEB value (-3~+3) on the display.

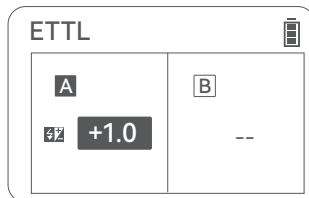

Short press the SET button to select group A flash/group B flash, turn the select dial to adjust the FEB value from -3 to +3 with an increment of 1/3 each stop.

Note:

1. "0.3" in FEB means 1/3 stop, "0.7" in FEB means 2/3 stop.
2. Adjust the FEB value to "±0" can cancel the FEB.

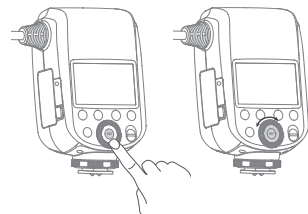

M (Manual) Flash Mode

Short press the MODE button to switch to <M> manual flash mode, and the <M> icon will be on the left upper corner of the display.

There are 3 flash modes: flash tube A and B flash in different flash ratio, only flash tube A or B flashes, flash tube A and B flash in the same flash ratio.

1. Overall Flash Ratio Setting

Short press the Ratio button to make <M> icon and output power on the display.

Turn the select dial to adjust the output power from 1/1 full power to 1/256 with an increment of 1/3 each stop.

Note: The minimum output is 1/64 when HSS is turned on.



2. A:B Flash Output Setting

Short press the Ratio button to make <A>: icon and two output values on the display.

Short press the SET button to select group A output /group B output, turn the select dial to adjust the group A output /group B output from 1/1 full power to 1/256 with an increment of 1/3 each stop.

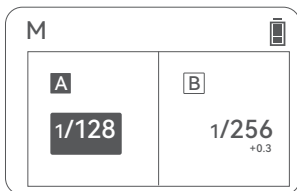

3. Single Group Flash Output Setting

Short press the Ratio button to make <A>: icon and single group output value on the display.

Short press the SET button to select group A output /group B output, turn the select dial to adjust the group A output /group B output from 1/1 full power to 1/256 with an increment of 1/3 each stop.

Note: If group A outputs flash, then group B is off.

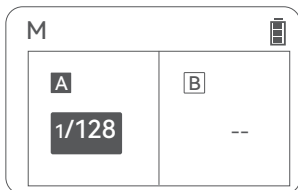

Transmitter Unit Setting

Set the flash status as a transmitter unit in the menu (please refer to the wireless setting).

Turn the select dial to switch group A/B/C/D. Turn the SET button to select, then short press the MODE button to switch to TTL/M/--. Turn the select dial in TTL mode to adjust the FEB value from -3 to +3 with an increment of 1/3 each stop. Turn select dial in M mode to adjust the output power from 1/1 full power to 1/256 with an increment of 1/3 each stop.

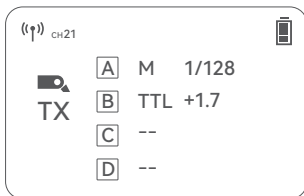

Note: TTL means TTL auto flash, M means manual flash, -- means off.

The parameter values of A, B, C and D in the interface are parameter values of receiver A, B, C and D. One transmitter unit can control four receiver units at most, and the transmitter unit output is group A output.

The wireless channel of the transmitter unit should be set the same as the receiver units in order to control them, please refer to the wireless setting.

Receiver Unit Setting

Set the flash status as a receiver unit in the menu (please refer to the wireless setting below).

Short press the SET button or turn the select dial to switch among A/B/C/D.

A means the flash is set as receiver A unit.

B means the flash is set as receiver B unit.

C means the flash is set as receiver C unit.

D means the flash is set as receiver D unit.

The wireless channel of the transmitter unit should be set the same as the receiver units, please refer to the wireless setting.

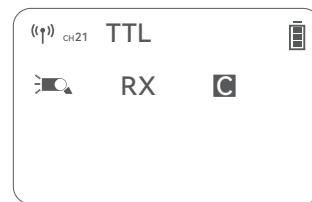
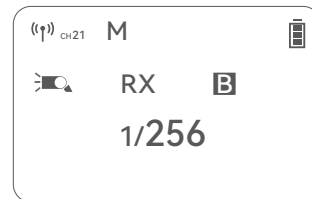

Wireless Setting

1. As a Transmitter Unit

Short press the MENU/lock button to enter the menu, turn the select dial to <WIRELESS>, short press the SET button to enter the wireless setting interface, turn the select dial to select <TX>, then short press the SET button to return to the previous menu.

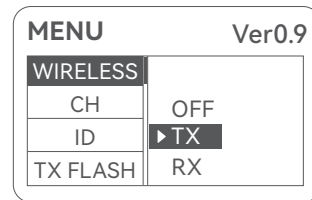

2. As a Receiver Unit

Short press the MENU/lock button to enter the menu, turn the select dial to <WIRELESS>, short press the SET button to enter the wireless setting interface, turn the select dial to select <RX>, then short press the SET button to return to the previous menu.

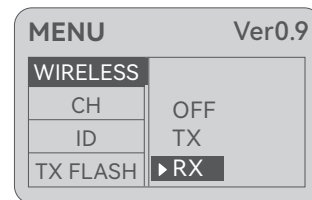

3. Transmitter Unit Flash Setting

Short press the MENU/lock button to enter the menu, turn the select dial to <TX FLASH>, short press the SET button to enter the wireless setting interface, turn the select dial to select <OFF> or <ON>.

If you choose <OFF>. Transmitter unit's flash is off, the flash will not fire in wireless shooting when using as a transmitter unit.

If you choose <ON>. Transmitter unit's flash is on, the flash will fire in wireless shooting when using as a transmitter unit.

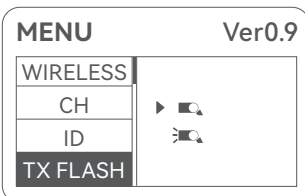

4. Wireless Channel Setting

Short press the MENU/lock button to enter the menu, turn the select dial to <CH>, short press the SET button to enter the wireless setting interface, turn the select dial to select among 01 to 32, then short press the SET button to return to the previous menu.

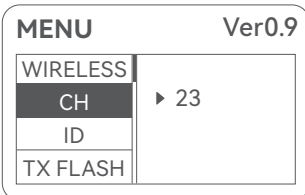

5. Wireless ID Setting

Short press the MENU/lock button to enter the menu, turn the select dial to <ID>, short press the SET button to enter the wireless setting interface, turn the select dial to select among OFF or 01 to 99, then short press the SET button to return to the previous menu.

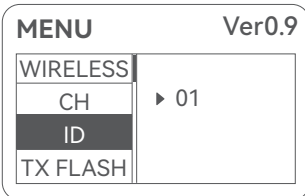

Wireless Multiple Flash Shooting (2.4G Wireless Transmission)

This chapter mainly explains how to perform wireless multiple shooting with 2.4G wireless transmission by using MF-R76C as the transmitter unit (refer to as "transmitter unit" below) and Godox flashes with 2.4G wireless receiving function such as MF-R76C, AD100PRO and V860III as the receiver unit (refer to as "receiver unit" below).

1. TTL: Wireless Multiple Flash Shooting in TTL Auto Flash Output Mode

Set the flash groups (A, B, C and D) of MF-R76C (transmitter unit) as <TTL>, no need to set the receiver units and they will perform wireless multiple flash shooting in auto flash. Set the FEB value on transmitter unit, no need to set the receiver units and they will follow the transmitter.

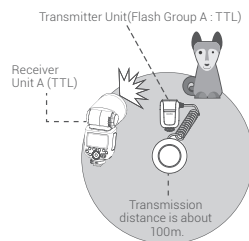

Auto Flash Shooting with One Receiver Unit

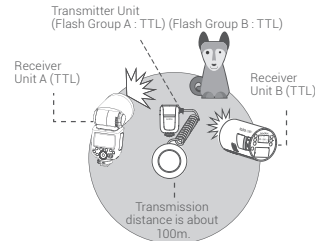

Auto Flash Shooting with Two Receiver Units

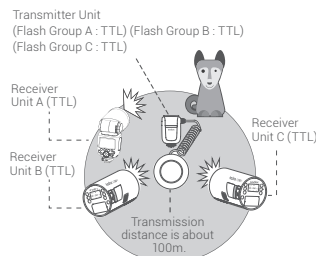

Auto Flash Shooting with Three Receiver Units

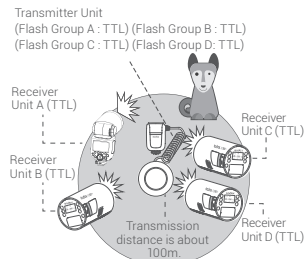

Auto Flash Shooting with Four Receiver Units

2. M: Wireless Multiple Flash Shooting in M Manual Flash Output Mode

Set the flash groups (A, B, C and D) of MF-R76C (transmitter unit) as either the same or different flash output power, no need to set the receiver units and they will perform wireless multiple flash shooting by following the transmitter.

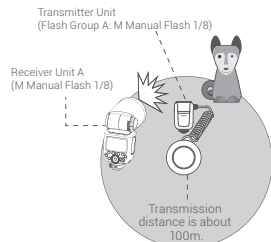

Auto Flash Shooting with One Receiver Unit

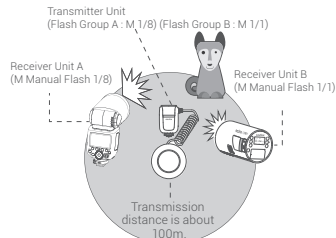

Auto Flash Shooting with Two Receiver Units

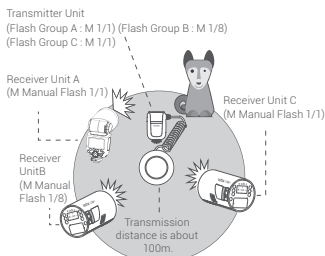

Auto Flash Shooting with Three Receiver Units

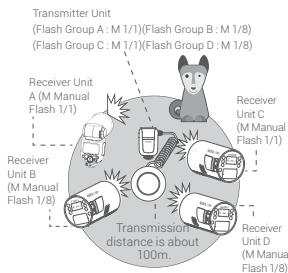

Auto Flash Shooting with Four Receiver Units

3. Wireless Multiple Flash Shooting in Different Flash Modes

Set the flash groups (A, B, C and D) of MF-R76C (transmitter unit) as the different flash modes, no need to set the receiver units and they will perform wireless multiple flash shooting in different flash modes. Set the FEB value on transmitter unit, no need to set the receiver units and they will follow the transmitter.

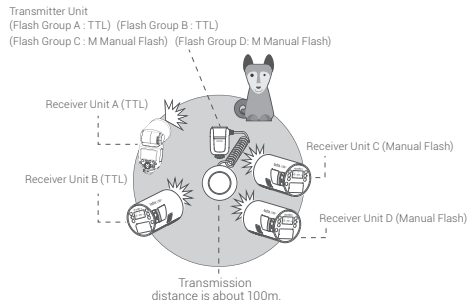

Note:

1. When the camera is set to fully automatic mode or program image control area mode, the operations in this chapter cannot be achieved. The wireless flash shooting can be achieved when the camera is set to P/Tv/Av /M/B (creative shooting).
2. The receivers mentioned in this chapter are all sold separately.
3. The flash output of the transmitter is group A by default.
4. If the receivers do not flash resulting from inconsistency of channels with the transmitter, please adjust them to the same. The channel setting of the receivers please refer to their instruction manuals.
5. Do not set obstacles between the transmitter and the receivers to avoid interference.
6. Please conduct flash test and shooting test before wireless multiple flash shooting.
7. Please refer to the wireless setting of menu setting for how to set the flash as a transmitter unit.
8. Please refer to the wireless setting of menu setting for how to set the flash as a receiver unit.
9. All the above descriptions in this chapter are based on the condition that MF-R76C is the transmitter.

⚡ High Speed Sync

MF-R76C is capable of producing high-speed flashes synchronized to the maximum speed of the camera's shutter, making it especially handy when taking pictures of the subject at soft light background.

1. Short press the MENU/lock button to enter the menu settings.
2. Turn the select dial to <SYNC>.
3. Short press the SET button to enter setting.
4. Turn the select dial to <⚡H >
5. Short press the MENU/lock button to return to the main interface, the <⚡H > icon will be on the right upper corner.

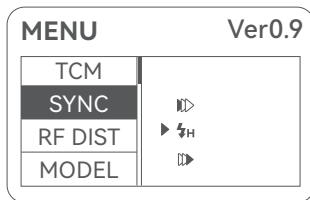

Note: The minimum power of M (manual) flash is 1/64 when HSS is on.

▶▶ First Curtain Sync

First curtain flash refers to the flash fires at moment when the first curtain is fully opened, this function is suitable for shooting scenes in general situations.

1. Short press the MENU/lock button to enter the menu settings.
2. Turn the select dial to <SYNC>.
3. Short press the SET button to enter setting.
4. Turn the select dial to <▶▶ >
5. Short press the MENU/lock button to return to the main interface.

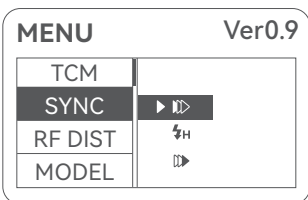

▶▶ Second Curtain Sync

Second curtain flash refers to the flash does not fire when the shutter is fully opened but fires at moment before the second curtain is closed, this function is suitable for shooting scenes in slow speed shutter.

1. Short press the MENU/lock button to enter the menu settings.
2. Turn the select dial to <SYNC>.
3. Short press the SET button to enter setting.
4. Turn the select dial to <▶▶ >
5. Short press the MENU/lock button to return to the main interface, the <▶▶ > icon will be on the right upper corner.

Note: The second curtain sync is unavailable in wireless multiple flash shooting (wireless transmitter/wireless receiver).



Focus Assist Beams

Short press the focus assist beam button to turn on or turn off the modeling light.

Focus assist beam adjustment: Turn on the focus assist beam, long press focus assist beam button to enter the setting interface, then turn the select dial to adjust in 1-10 steps. After which, long press to exit.

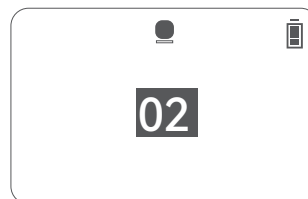

Locking Function

Long press the MENU/lock button to lock or unlock the display.

Short press any button in locked status won't work, and that's to avoid maloperation in shooting.

Note: Long press the MENU/lock button won't work in menu interface means it's not locked.

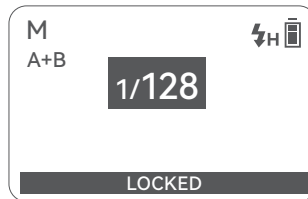

Sync Cord Jack Trigger

The sync cord or trigger plug can be inserted into the 2.5mm sync port to fire the flash.

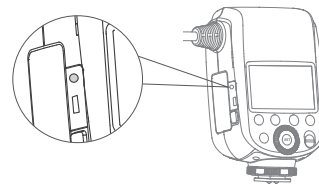

Over-Temperature Protection

To avoid overheating and deteriorating the flash head, do not fire more than 30 continuous flashes in fast succession at 1/1 full power. After 30 continuous flashes, allow a rest time of at least 10 minutes.

If you fire more than 30 continuous flashes and then fire more flashes in short intervals, the inner overtemperature protection function may be activated and <  > is shown on the display. If this occurs, allow a rest time of about 10 minutes, and the flash unit will then return to normal.

Number of flashes that will activate over-temperature protection:

Power Output Level	Number of Flashes
1/1	60
1/2	80
1/4	150
1/8	200
1/16	340
1/32	540
1/64	1000
1/128	1000
1/256	1000

Number of flashes that will activate over-temperature protection in HSS mode:

Power Output Level	Number of Flashes
1/1	30
1/2	30
1/4	35
1/8	40
1/16	50
1/32	50
1/64	60

Other Protections





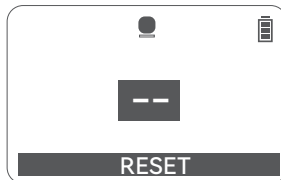

Prompts on the panel	Meaning
E0	A failure occurs on the temperature sensor inside the device, need to be repaired.
E1	A failure occurs on the recycling system so that the flash cannot fire. Please restart the flash unit. If the problem still exists, please send this product to a maintenance center.
E2	The system gets excessive heat. Please allow a rest time of 10 minutes.
E3	The voltage on two outlets of the flash tube is too high. Please send this product to a maintenance center.

Light Body Reset

Long press the focus assist beam button and MENU button until "RESET" icon appears, when the "RESET" icon disappears means reset completed.



Menu Setting

First option	Secondary option	Meaning
WIRELESS	OFF	Turn off wireless
	TX	Turn on transmitter's wireless
	RX	Turn on receiver's wireless
CH	01-32	32 channels
ID	OFF	Turn off ID
	01-99	99 IDs
TX FLASH		Turn off the transmitter's flash when using as a transmitter unit.
		Turn on the transmitter's flash when using as a transmitter unit.
TCM	OFF	Off
	ON	On (Short press the MODE button can realize TCM transform when this function is switched on. This function is unavailable in wireless flash or single port flash.)
SYNC		First curtain sync
		High speed sync
		Only when the WIRELESS is OFF, the second curtain sync function is available.
RF DIST	0.3-10m	Trigger distance: 0.3-10m
	1-100m	Trigger distance: 1-100m
MODEL	 CONT	Turn on the modeling light, it will not go out when the flash fires.
	 INTER	Turn on the modeling light, it will go out when the flash fires.
STBY	ON	Turn on sleep mode when using as a transmitter unit.
	OFF	Turn off sleep mode when using as a transmitter unit.
RX STBY	60 mins	Enter sleep mode after 60 minutes of idle use when using as a receiver unit.
	30 mins	Enter sleep mode after 30 minutes of idle use when using as a receiver unit.
	OFF	Turn off sleep mode when using as a receiver unit.
BL	12 secs	Backlight off over 12 seconds of idle use.
	OFF	Backlight always off
	ON	Backlight always lighting
LCD	-3~+3	The contrast ration can be set in7 levels.

Technical Data

Product Name	TTL Macro Ring Flash
Model	MF-R76C
Guide No.	GNT14(ISO 100, in meter)
Compatible Camera	Canon
Lithium Battery	7.2V/2980mAh
Flash Power (1/1 Power Output)	76Ws
Flash CCT	5900K±200K
Focus assist beams Power	0.7W×2
Focus assist beams CCT	5300K±200K
Flash Power Range	1/1-1/256 (with 1/3 increment each stop)
Flash Duration	1/300s~1/20000s
Flash Mode	TTL Flash, M (Manual) Flash
FEB	-3~+3 EV (FEB value), with 1/3 EV increment each stop
HSS	Yes
First Curtain Sync	Yes
Second Curtain Sync	Yes
Inner Diameter of Light Body	77mm
Recycle Time	0.1-1s
Full Power Flashes	550
Wireless Transmission Distance	0-100m
CH	32 groups: 01-32
ID	99: 01-99
Working Environment Temperature	-10~50°C
Ring Flash Dimension	130×130×27mm/5.1×5.1×1 inches
Controller Dimension	120×70×50mm/4.7×2.7×1.9 inches
Net Weight (with battery)	578g/20.39oz

All the above data are based on Godox testing standards.
Design and specifications may be subject to change without notice.

List of Compatible Canon Cameras

80D, 90D, 7D, 6D, 70D, 750D/760D, 5DMarkIV, EOS 1DX, 6DMarkII, 77D, 800D, 5DMarkIII, 5DMarkII, 60D, 7D Mark II, 600D, 50D, 30D, 500D, Digital X, M5, M50, R, RP, 1500D, 3000D

Note:

- This table only lists the tested camera models, not all Canon series cameras. For the compatibility of other camera models, a self-test is recommended.
- Rights to modify this table are retained.

Troubleshooting Guide

Please refer to the guide table below when problems occur.

Problem	Possible reason	Solution
Flash does not fire	Not correctly installed	Please mount the hotshoe of the flash securely on the camera.
	The electronic contacts of the flash and camera are dirty	Clean the electronic contacts of the flash and camera.
Power down automatically	The power will automatically shut down over 90s of idle use when using as a transmitter unit and the STBY is on.	Press any button to wake up
	The power will automatically shut down over 60min or 30min of idle use when using as a receiver unit and the RX STBY is set as 60mins or 30mins.	Press any button to wake up
Can not boot up	Battery runs out or damages	Please charge or replace the battery.
Flash does not fire as a receiver unit	The receiver's flash group is incorrect. For example, group B of the transmitter is off but the receiver is set as group B.	Set the flash group of receiver correctly.
	The channels of transmitter and receiver are inconsistent.	Please set the channels of transmitter and receiver to the same, e.g., set the channel of transmitter to 01, and receiver's to 01 as well.
	The receiver is out of the transmission distance of the transmitter.	Please set the receiver within the transmission distance (0-100m) of the transmitter.
	The transmitter and receiver are too close for transmission.	Please set the triggering distance in MENU-RF DIST as 0.3m to 10m.

Firmware Upgrade

- This product supports firmware upgrade through the Type-C USB port, please use Type-C USB connection line (sold separately).
- As the firmware upgrade needs the support of Godox G3 software, please download and install the "Godox G3 firmware upgrade software" before upgrading from our official website <https://www.godox.com>. Then, choose the related firmware file.
- Please refer to the latest electronic version of the instruction manual.

The Reason & Solution of Not Triggering in Godox 2.4G Wireless

- Disturbed by the 2.4G signal in outer environment (e.g. wireless base station, 2.4G wifi router, Bluetooth, etc.)**
→ To adjust the channel CH setting on the flash trigger (add 10+ channels) and use the channel which is not disturbed. Or turn off the other 2.4G equipment in working.

2. Please make sure that whether the flash has finished its recycle or caught up with the continuous shooting speed or not (the flash ready indicator is lighten) and the flash is not under the state of over-heat protection or other abnormal situation.

→ Please downgrade the flash power output. If the flash is in TTL mode, please try to change it to M mode (a preflash is needed in TTL mode).

3. Whether the distance between the flash trigger and the flash is too close or not (<0.5m).

→ Please turn on the "close distance wireless mode" on the flash trigger.

→ Please set the MENU- -DIST to 0-30m.

4. Whether the flash trigger and the receiver end equipment are in the low battery states or not

→ Please replace the battery.

Maintenance

Shut down the device immediately should abnormal operation be detected.

Avoid sudden impacts and the product should be dedusted regularly.

It is normal for the flash tube to be warm when in use. Avoid continuous flashes if unnecessary.

Maintenance of the flash must be performed by our authorized maintenance department which can provide original accessories.

This product, except consumables e.g. flash tube, is supported with a one-year warranty.

Unauthorized service will void the warranty.

If the product had failures or was wetted, do not use it until it is repaired by professionals.

Changes made to the specifications or designs may not be reflected in this manual.

FCC Statement

This device complies with part 15 of the FCC Rules. Operation is subject to the following two conditions:

(1) This device may not cause harmful interference, and

(2) this device must accept any interference received, including interference that may cause undesired operation.

Any Changes or modifications not expressly approved by the party responsible for compliance could void the user's authority to operate the equipment.

Note: This equipment has been tested and found to comply with the limits for a Class B digital device, pursuant to part 15 of the FCC Rules. These limits are designed to provide reasonable protection against harmful interference in a residential installation. This equipment generates uses and can radiate radio frequency energy and, if not installed and used in accordance with the instructions, may cause harmful interference to radio communications. However, there is no guarantee that interference will not occur in a particular installation. If this equipment does cause harmful interference to radio or television reception, which can be determined by turning the equipment off and on, the user is encouraged to try to correct the interference by one or more of

the following measures:

-Reorient or relocate the receiving antenna.

-Increase the separation between the equipment and receiver.

-Connect the equipment into an outlet on a circuit different from that to which the receiver is connected.

-Consult the dealer or an experienced radio/TV technician for help.

The device has been evaluated to meet general RF exposure requirement.

The device can be used in portable exposure condition without restriction.

Warning

Operating frequency:2412.99MHz – 2464.49MHz

Maximum EIRP Power:4.37dBm

Declaration of Conformity

GODOX Photo Equipment Co.,Ltd. hereby declares that this equipment are in compliance with the essential requirements and other relevant provisions of Directive 2014/53/EU. In accordance with Article 10(2) and Article 10(10), this product is allowed to be used in all EU member states.For more information of DoC, Please click this web link:

<https://www.godox.com/eu-declaration-of-conformity/>

The device complies with RF specifications when the device used at 0mm from your body.

产品保修

尊敬的用户, 本保修卡是申请保修服务的重要凭证, 请您配合销售商填写并妥善保管, 谢谢!

产品信息	型号	产品条码
用户信息	姓名	联系电话
	通信地址	
销售商信息	名称	
	联系电话	
	通信地址	
	销售日期	
备注		

注: 此表应由销售商盖章确认。

产品信息

本文件适用于相关《产品保修信息》(见后面说明)所列产品, 其他非属此范围的产品或部件(如促销品、赠品及其他出厂后附加的部件等)不在此保修承诺内。

保修期

产品及部件的相应保修期按相关的《产品保修信息》执行。保修期自产品首次购买日起算, 购买日以购买产品时保修卡登记日期为准。

如何获得保修服务

您可直接与产品销售商或授权服务机构联系, 也可拨打神牛产品售后服务电话, 与我们联系, 由我们的服务人员为您安排服务。申请保修时, 您应提供有效的保修卡作为保修凭证, 方可获得保修。如您不能提供有效的保修卡, 则在我们确认产品或部件属于保修范围的情况下, 也可以为您提供保修, 但这不作为我们的义务。

不适用保修的情况

如产品存在下列情况, 本文件项下的保证和服务将不适用: ①产品或部件超过相应保修期; ②错误或不当使用、维护或保管导致的故障或损坏, 如: 不当搬运; 非按产品合理预期用途使用; 不当插拔外接设备; 跌落或外力挤压; 接触或暴露于不适当温度、溶剂、酸碱、水浸或潮湿环境; ③由非神牛授权机构或人员安装、修理、更改、添加或拆卸造成的故障或损坏; ④产品或部件原有识别信息被修改变更或删除; ⑤无有效保修卡; ⑥使用非合法授权、非标准或非公开发行的软件造成的故障或损坏; ⑦因不可抗力或意外事件造成的故障或损坏; ⑧其他非因产品本身质量问题导致的故障或损坏。遇上述情况, 您应向相关责任方寻求解决, 神牛对此不承担任何责任。因非在保修期或保修范围内的部件、附件或软件导致产品不能正常使用的, 不是保修范围内的故障。产品使用过程中正常的脱色, 磨损和消耗, 不是保修范围内的故障。

产品保修和服务支持信息

产品的保修期和服务类型按以下《产品保修信息》执行:

产品类别	选件名称	保修期(月)	保修服务类型
部件	主机	12	客户送修
	电池	3	客户送修
	充电器等带电性能的部件。	12	客户送修
其他	如电源线、同步线闪光灯管、造型灯泡、外壳、保护罩、锁紧装置、包装等。	无	无保修

神牛产品售后服务电话 0755-29609320-8062

Warranty

Dear customers, as this warranty card is an important certificate to apply for our maintenance service, please fill in the following form in coordination with the seller and safe-keep it. Thank you!

Product Information	Model	Product Code Number
Customer Information	Name	Contact Number
	Address	
Seller Information	Name	
	Contact Number	
	Address	
	Date of Sale	
Note		

Note: This form shall be sealed by the seller.

Applicable Products

The document applies to the products listed on the Product Maintenance Information (see below for further information). Other products or accessories (e.g. promotional items, giveaways and additional accessories attached, etc.) are not included in this warranty scope.

Warranty Period

The warranty period of products and accessories is implemented according to the relevant Product Maintenance Information. The warranty period is calculated from the day (purchase date) when the product is bought for the first time. And the purchase date is considered as the date registered on the warranty card when buying the product.

How to Get the Maintenance Service

If maintenance service is needed, you can directly contact the product distributor or authorized service institutions. You can also contact the Godox after-sale service call and we will offer you service. When applying for maintenance service, you should provide valid warranty card. If you cannot provide valid warranty card, we may offer you maintenance service once confirmed that the product or accessory is involved in the maintenance scope, but that shall not be considered as our obligation.

Inapplicable Cases

The guarantee and service offered by this document are not applicable in the following cases: ① The product or accessory has expired its warranty period; ② Breakage or damage caused by inappropriate usage, maintenance or preservation, such as improper packing, improper usage, improper plugging in/out external equipment, falling off or squeezing by external force, contacting or exposing to the improper temperature, solvent, acid, base, flooding and damp environments, etc; ③ Breakage or damage caused by non-authorized institution or staff in the process of installation, maintenance, alternation, addition and detachment; ④ The original identifying information of product or accessory is

modified, alternated, or removed; ⑤ No valid warranty card; ⑥ Breakage or damage caused by using illegally authorized, nonstandard or non-public released software; ⑦ Breakage or damage caused by force majeure or accident; ⑧ Breakage or damage that could not be attributed to the product itself. Once met these situations above, you should seek solutions from the related responsible parties and Godox assumes no responsibility. The damage caused by parts, accessories and software that beyond the warranty period or scope is not included in our maintenance scope. The normal discoloration, abrasion and consumption are not the breakage within the maintenance scope.

Maintenance and Service Support Information

The warranty period and service types of products are implemented according to the following Product Maintenance Information:

Product Type	Name	Maintenance Period(month)	Warranty Service Type
Parts	Circuit Board	12	Customer sends the product to designated site
	Battery	3	Customer sends the product to designated site
	Electrical parts e.g battery charger, etc.	12	Customer sends the product to designated site
Other Items	Flash tube, power cord, sync cable, modeling lamp, lamp body, lamp cover, locking device, package, etc.	No	Without warranty

Godox After-sale Service Call +86-755-29609320(8062)