

合格证

QC PASS



Wechat  
Official Account  
神牛微信公众号

### 深圳市神牛摄影器材有限公司

地址：深圳市宝安区福海街道塘尾社区耀川工业园厂房 2 栋  
电话：0755-29609320 (8062) 传真：0755-25723423 邮箱：godox@godox.com

### GODOX Photo Equipment Co., Ltd.

Add.: Building 2, Yaochuan Industrial ZoneTangwei Community, Fuhai Street, Bao'an District, Shenzhen  
518103, China Tel: +86-755-29609320(8062) Fax: +86-755-25723423 E-mail: godox@godox.com

[www.godox.com](http://www.godox.com)

Made in China | 705-ML10K3-00



Godox

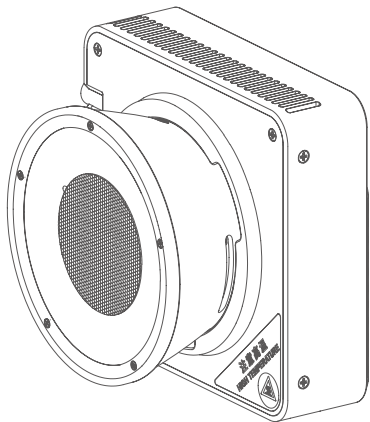

# ML100 Bi

便携 LED 摄影灯  
Portable LED Video Light

使用手册  
Instruction Manual

## 重要的安全说明及注意事项

首先作为最基本原则：本产品为专业灯光布景设备，应由专业灯光师使用或在专业人士指导下使用。使用时必须始终遵循基本的安全预防措施，具体安全预防措施如下：

1. 使用前必须阅读并理解产品说明书。
2. 专业灯具，禁止儿童使用。当儿童靠近时，家长或监护人必须密切监督，以免儿童因碰撞灯具或私用灯具造成人身伤害。
3. 本灯具并非普通照明灯具，不可用于普通照明，任何有过眼部损伤或眼部敏感的人群均应避免使用本灯具。
4. 灯具点亮时，必须小心使用，禁止接触高温部件，如 LED 灯珠，以免造成灼伤。
5. 灯具点亮时，任何情况下均禁止直视灯珠。应该在专业灯光师指导下使用强光，任何情况下避免长时间处于强光环境，如引起眼睛不适，请及时关闭灯具，暂停使用，请及时就医。
6. 倘灯珠损坏或因热变形，应停止使用，并及时联系制造商、服务代理商或合格的维修人员更换灯珠，以免发生意外。
7. 本产品仅适用于  $-10^{\circ}\text{C} \sim 40^{\circ}\text{C}$  工作环境温度及正常湿度环境下使用。
8. 请勿使用损坏的设备或设备配件，待专业维修人员检查维修，确认设备正常方可使用。
9. 在使用过程中，如果本产品由于跌落、受到挤压或遭受强烈冲击而造成外壳破裂的，请勿继续使用，以免因接触到内部电子元件而受到电击伤害。
10. 在清洁和维修之前，请务必从电源插座上拔下该设备插头。不使用时，禁止拉扯电源线以将设备插头从电源插座中拔出。正常断电，应是用手抓住该设备插头两端，将插头从电源插座中拔出。此设备需连接到接地插座中。
11. 本设备没有防水性能，请让设备保持干燥，请勿将本设备浸入水中或其他液体中。设备需安装在干燥且通风处，避免在雨天、潮湿、多尘或过热环境下使用。请勿将任何物体置于灯具上或使液体流入灯具内部，以免发生意外。
12. 请勿私自拆卸产品，如产品出现故障，须由本公司或授权的维修人员进行检查维修。
13. 存放本设备之前，请确保设备已完全冷却。存放时，将电源线从设备上拔出。设备应放置于设备便携包内或通风干燥处。
14. 请勿将设备放置在酒精、汽油等易燃易挥发的溶剂附近。
15. 本厂不推荐的产品附件，请勿使用，以免导致火灾、触电或人身伤害。
16. 清洁本设备时，请勿用湿布擦拭，请用干布，软布擦拭设备污垢。
17. 设备使用前，请注意将保护罩取下。
18. 本产品已通过 ROHS, CE 和 FCC 认证，请参考相关国家标准使用和操作。
19. 安全说明依据本厂严格测试制定，设备设计和规格如有变更，恕不另行通知。客户可以上神牛官网查看最新的电子版说明，了解产品最新资讯。
20. 一年保修期，消耗品电池、适配器、电源线等配件不在此保修范围内。
21. 经发现，擅自检修设备，将取消一年保修期，维修需要收取相关费用。
22. 对于不规范操作引起的机器故障不在保修范围内。





**保存这些说明**

## 前言

感谢您购买神牛产品。

神牛全新推出便携 LED 摄影灯 ML100Bi，其机身方正而薄，底部设有 1/4" 螺丝口，可兼容市面上绝大多数三脚架。此外，ML100Bi 支持“Godox light”App 无线控制；具备两种模式：双色温模式和 11 类 FX 场景光效模式；适用于户外直播、室内直播、视频拍摄等场景。

### 警告

-  设备使用前，请务必将灯头保护罩取下。
-  注意灯珠高温，使用时请勿触碰光源处。
-  请勿私自拆卸产品，如产品出现故障须由本公司或授权的维修人员进行检查维修。
-  设备在使用时请注意灯头表面壳体的高温，切勿长时间触摸；设备在结束工作后表面仍会留有较高余温，请等待灯体冷却后再进行长时间触摸。



人眼不可直视

## 部件名称

### 灯体

1. 显示屏
2. 开关按钮
3. MODE/  按钮
4. 调节旋钮
5. 风扇口
6. 卡口推制
7. 神牛卡口
8. DC 输入接口
9. USB-C 输入接口
10. 1/4" 接口

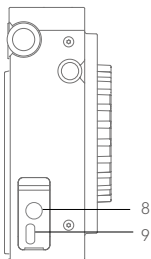
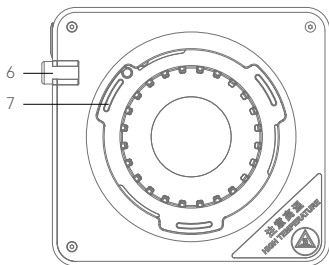
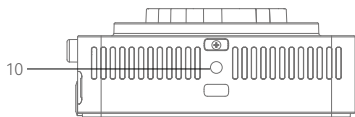
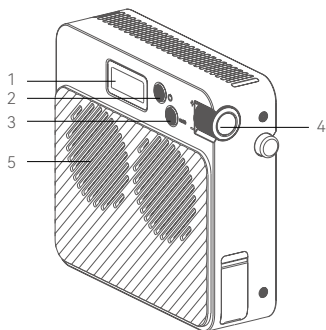

## ML100Bi 标配清单

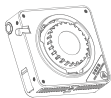

灯体 ×1



透镜反光杯 ML-L15 ×1



支架 AD-E2 ×1



灯头保护罩 ×1



适配器 ×1



AC 电源线 ×1



说明书 ×1

## ML100Bi (With Carry Bag) 清单



灯体 ×1



透镜反光杯 ML-L15 ×1



支架 AD-E2 ×1



灯头保护罩 ×1



适配器 ×1



AC 电源线 ×1



收纳包 ×1



说明书 ×1

## ML100Bi Kit1 套装清单



灯体 ×1



透镜反光杯 ML-L15 ×1



透镜反光杯 ML-L36 ×1



支架 AD-E2 ×1



灯头保护罩 ×1



适配器 ×1



AC 电源线 ×1

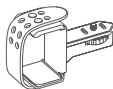

移动电源支架 PH01 ×1



迷你三脚架 MT01 ×1



收纳包 ×1



说明书 × 1

## ML100Bi Kit2 套装清单

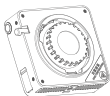

灯体 ×1



透镜反光杯  
ML-L15 ×1



透镜反光杯  
ML-L36 ×1



灯头保护罩 ×1



支架 AD-E2 ×1



V 口电池附件套装  
AK-B02 ×1



适配器 ×1



AC 电源线 ×1



收纳包 ×1



说明书 ×1

## ML100Bi Kit3 套装清单

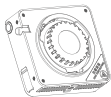

灯体 ×3



透镜反光杯  
ML-L15 ×1



透镜反光杯  
ML-L36 ×1



灯头保护罩 ×3



支架 AD-E2 ×3



适配器 ×3



AC 电源线 ×3



60cm 柔光箱  
AD-S60S ×1

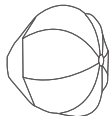

30cm 柔光球  
ML-CS30 ×1



灯架 BS-3R-FE-190 ×3



收纳包 ×1



说明书 ×1

## 另购附件

八角柔光箱 ML-SF50、球形灯笼柔光箱 ML-CS30、透镜反光杯 ML-L36、透镜反光杯 ML-L15、移动电源支架 PH01、神牛转保荣卡口转接环 ML-GB。

## 电源管理

**DC 供电:** 通过适配器连接交流电, 输入 20V $\overline{=}$  6A

**Type-C 供电:** 您可另购充电头或充电宝进行供电, 具体输出亮度将根据使用的充电头或充电宝的功率值来调整。

**AK-B02 供电:** 您可另购 AK-B02 V 口电池附件套装和 V 口电池, 通过接入一节 14.8V 的 V 口电池进行供电。



## 安装灯头保护罩

将灯头保护罩对准神牛卡口插入，顺时针旋转灯头保护罩，听到“咔”一声即可安装完毕。

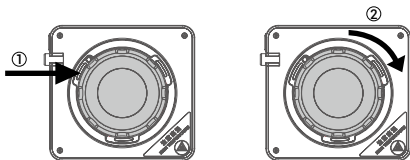

## 拆卸灯头保护罩

推动灯具卡口推制的同时，逆时针旋转灯头保护罩，即可取下灯头保护罩。

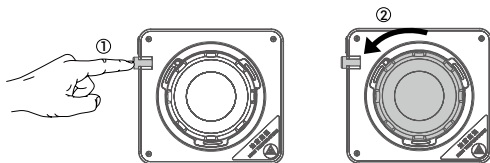

## 安装透镜反光杯

将透镜反光杯对准神牛卡口插入，顺时针旋转透镜反光杯，听到“咔”一声即可安装完毕。

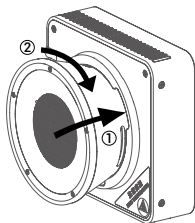

## 拆卸透镜反光杯

推动灯具卡口推制的同时，逆时针旋转透镜反光杯，即可取下透镜反光杯。

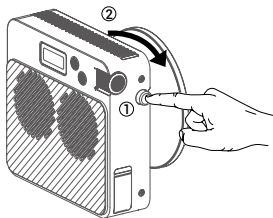

## 开机 / 关机

接通电源后，长按开关按键即可实现开机 / 关机。

## 色温模式

短按 MODE/  按键可切换模式。当显示屏显示“CCT”即表示当前模式为色温模式，短按调节旋钮可选色温 / 亮度。

选中色温时，滚动调节旋钮可调节色温值，向上滚动一次增加 100K 色温，向下滚动一次减少 100K 色温，色温范围为 2800-6500K。

选中亮度时，滚动调节旋钮可调节亮度值，向上滚动一次增加 1% 亮度，向下滚动一次减少 1% 亮度，亮度范围为 0% -100%。

## FX 场景光效模式

短按 MODE/  按键可切换模式。当显示屏显示“FX”即表示当前模式为 FX 场景光效模式，短按调节旋钮可选光效 / 光效参数 / 亮度。

选中光效时，滚动调节旋钮可选择光效类型，共有 11 类。

选中光效参数时，滚动调节旋钮可调节具体光效参数，调节范围如下表所示。

选中亮度时，滚动调节旋钮可调节亮度值，向上滚动一次增加 1% 亮度，向下滚动一次减少 1% 亮度，亮度范围为 0% -100%。

序号	光效图标	光效类型	选项	调节范围
1		闪光灯	SPD (速度)	1-100
2		雷闪电	FREQ( 频率)	RANDOM( 随机 )/2-20
3		多云	SPD (速度)	RANDOM( 随机 )/1-100
4		坏灯泡	SPD (速度)	1-100
5		电视机	SPD (速度)	1-100
6		蜡烛	SPD (速度)	1-100
7		火	SPD (速度)	1-100
8		烟花	SPD (速度)	1-100
9		爆炸	SPD (速度)	1-100
10		焊接	SPD (速度)	1-100
11	<b>SOS</b>	SOS	CCT (色温)	2800K-6500K

## 蓝牙设置

长按 MODE/  按钮进入蓝牙设置，滚动调节旋钮可选蓝牙重置 (RESET)/ 蓝牙开启 (ON)/ 蓝牙关闭 (OFF)。

蓝牙重置 (RESET): 选中蓝牙重置 (RESET) 后，短按调节旋钮即可进行蓝牙重置，重置完毕自动返回主界面。

蓝牙开启 (ON): 蓝牙开启后，可使用“Godox Light”App 连接灯体。

蓝牙关闭 (OFF): 蓝牙关闭后，无法使用“Godox Light”App 连接灯体。

扫描下面二维码即可下载“Godox Light”App (安卓和苹果系统都可以使用)。



注：首个移动设备（手机或平板电脑）可直接使用 App 操控灯体。更换其他移动设备时，灯体需进行蓝牙重置方可正常使用 App。App 需升级至 V3.0 以上版本。

## 低电提示

通过 DC 电源口连接外置电池组供电，当电池电量低于一格时，显示屏自动弹出低电量提示符号。



## 高温报警提示

当显示屏顶部显示  时，即表示当前灯体灯珠温度过高，建议您暂停使用，待显示屏不再显示 ，您方可再次使用。

当显示屏全屏显示  时，即表示当前灯体温度过高，灯体自动启动灭灯功能，待灯珠温度恢复正常后，灯体恢复正常。

## 照度数据

色温	测试条件	照度单位	1m	2m	3m
2800K	裸灯	lux	≈ 2580	≈ 682	≈ 316
		fc	≈ 239	≈ 63	≈ 29
	带透镜反光杯 ML-L15	lux	≈ 24100	≈ 6010	≈ 2800
		fc	≈ 2240	≈ 558	≈ 260
	带透镜反光杯 ML-L36	lux	≈ 12500	≈ 3140	≈ 1380
		fc	≈ 1160	≈ 292	≈ 128
3200K	裸灯	lux	≈ 2990	≈ 777	≈ 363
		fc	≈ 278	≈ 72	≈ 34
	带透镜反光杯 ML-L15	lux	≈ 27900	≈ 7040	≈ 3250
		fc	≈ 2590	≈ 654	≈ 302
	带透镜反光杯 ML-L36	lux	≈ 14500	≈ 3640	≈ 1610
		fc	≈ 1350	≈ 338	≈ 150
4300K	裸灯	lux	≈ 3520	≈ 916	≈ 427
		fc	≈ 327	≈ 85	≈ 40
	带透镜反光杯 ML-L15	lux	≈ 32900	≈ 8350	≈ 3860
		fc	≈ 3060	≈ 776	≈ 359
	带透镜反光杯 ML-L36	lux	≈ 17100	≈ 4320	≈ 1910
		fc	≈ 1590	≈ 401	≈ 177
5600K	裸灯	lux	≈ 3670	≈ 953	≈ 446
		fc	≈ 341	≈ 89	≈ 41
	带透镜反光杯 ML-L15	lux	≈ 34300	≈ 8800	≈ 4040
		fc	≈ 3190	≈ 817	≈ 376
	带透镜反光杯 ML-L36	lux	≈ 17900	≈ 4480	≈ 1990
		fc	≈ 1660	≈ 416	≈ 185
6500K	裸灯	lux	≈ 3380	≈ 878	≈ 410
		fc	≈ 314	≈ 82	≈ 38
	带透镜反光杯 ML-L15	lux	≈ 31200	≈ 8100	≈ 3730
		fc	≈ 2840	≈ 752	≈ 346
	带透镜反光杯 ML-L36	lux	≈ 16500	≈ 4130	≈ 1830
		fc	≈ 1530	≈ 383	≈ 170

以上数据非绝对值，为平均值，以上测试皆在灯体 100%亮度下进行。上述透镜反光杯 ML-L15 为标配，透镜反光杯 ML-L36 为另购。

## 规格参数

型号	ML100 Bi
供电	20V $\overline{=}$ 6A
最大输入功率	$\approx$ 120W
调光范围	0% -100%
CRI	平均 $\geq$ 97
TLCI	平均 $\geq$ 98
色温	2800-6500K
场景光效	11 类
蓝牙控制范围	最远 30m
工作环境温度	-10°C ~+40°C
尺寸 (不含透镜反光杯)	$\approx$ 122mm $\times$ 110mm $\times$ 46mm
净重 (不含透镜反光杯)	$\approx$ 487g

规格和参数如有变更, 恕不另行通知。

## 维修保护

1. 为防止灰尘堆积影响到产品性能, 请定时用干净的湿布轻轻擦拭产品外部。
2. 1 年保修, 消耗品如充电电源线等配件不在保修范围内。
3. 对于不规范操作引起的机器故障不在保修范围内。
4. 所有维修概由本厂指定的可供原厂配件的维修部负责。
5. 经发现, 擅自维修本产品, 将取消一年的保修期, 维修需收取相关费用。
6. 如果本品出现故障或被水淋湿, 在专业人员维修后方可使用。如有技术更改, 恕不另行通知。

## Safety Instructions and Attentions

**First of all, as the most basic principle: This product is a professional lighting set equipment and should be used by professional lighting engineers or under the guidance of professionals. Basic safety attentions must always be followed during use, as follows:**

1. Before use, please read and understand these instructions and attentions.
2. Professional lighting is prohibited for children. When children are near, parents or accompanying persons must supervise closely to prevent children from personal injury due to collision with lamps or private use of lamps.
3. This lighting product is not ordinary lighting product and cannot be used for general lighting. Anyone who has suffered eye damage or has sensitive eyes should avoid using this product.
4. When the lamp is on, it must be used with care. Do not touch high-temperature parts, such as LED lamp beads, to avoid burns.
5. When the lamp is on, it is forbidden to look directly at the lamp beads under any circumstances. Strong light should be used under the guidance of professional lighting engineers. Avoid prolonged exposure to strong light under any circumstances. If eye discomfort, please turn off the lamp in time, suspend use, and see a doctor immediately.
6. If the lamp bead is damaged or deformed by heat, stop using this equipment, and contact the manufacturer, service agent or qualified maintenance personnel to replace the lamp bead in time to avoid accidents.
7. This product is only suitable for use in -10°C to 40°C operating environment and normal humidity environment.
8. Do not use damaged equipment or accessories, and wait for professional maintenance personnel to check and repair to confirm being normal before use.
9. During using, if the casing of this product is broken due to being dropped, squeezed or subjected to strong impact, please do not use it, so as to avoid electric shock injury due to contact with internal electronic components.
10. Be sure to unplug equipment from the power outlet before cleaning and repairing. When not in use, do not pull the power cord to unplug the equipment. For normal power-off, please hold both ends of the plug of the equipment with your hands and pull the plug out of power outlet. This equipment needs to be connected to a grounded outlet.
11. This equipment is not waterproof, please keep it dry and do not immerse it in water or other liquids. The equipment should be installed in a dry and ventilated place, and avoid using it in rainy, humid, dusty or overheated environments. Do not place any objects on the lamp or let liquid flow into the lamp to avoid accidents.
12. Do not disassemble the product without permission. If the product fails, it must be checked and repaired by authorized maintenance personnel.
13. Before storing, make sure that the equipment has cooled down completely. For storage, unplug the power cord from the equipment. The equipment should be placed in the carrying case or in a ventilated dry place.
14. Do not place equipment near flammable and volatile solvents such as alcohol and gasoline.
15. Do not use accessories that are not recommended by our factory to avoid fire, electric shock or personal injury.
16. When cleaning, do not wipe it with a damp cloth, please use a dry cloth or a soft cloth to wipe the dirt of the equipment.
17. Please take off the protective cover before using.
18. This product complies with ROHS, CE, and FCC certification, please refer to the relevant national standards for use and operation.

19. The safety instructions are formulated according to the strict testing of the factory, and the design and specifications of the equipment are subject to change without prior notice. For latest product information, please check the GODOX website and view latest electronic instruction.
20. One-year warranty period, accessories such as consumable batteries, adapters, power cords, etc. are not covered by this warranty.
21. If it is found that the equipment is repaired without authorization, the one-year warranty period will be cancelled and relevant fees will be charged for maintenance.
22. Machine failures caused by non-standard operation are not covered by the warranty.





keep these instructions!

## Foreword

Thank you for purchasing a Godox product.

Godox introduces the new portable LED video light ML100Bi. It features a square and slim body with a 1/4" screw hole at the bottom, making it compatible with most tripods available in the market. In addition, the ML100Bi supports wireless control through the "Godox light" app, offering two modes: bi-color temperature mode and 11 types of FX modes. This product is suitable for outdoor livestreaming, indoor livestreaming, video shooting, and other scenarios.

### **Warning**

-  Before using the device, please make sure to remove the lamp head protective cover.
-  The light beads generate high temperatures. Do not touch the light source during use.
-  Do not disassemble the product by yourself. If the product malfunctions, it should be inspected and repaired by our company or authorized personnel.
-  Be careful of the high temperature on the light head surface shell in using, and do not touch for a long time. The surface will still have a high residual temperature after the end of work, please wait for the light body to cool down before touching it for a long time.



Don't stare at a bright light source



## Name of Parts

### Light Body

1. Display
2. Power Switch
3. MODE/  Button
4. Select Dial
5. Fan Vent
6. Mount Locking Pusher
7. Godox Mount
8. DC Input Port
9. USB-C Input Port
10. 1/4" Interface

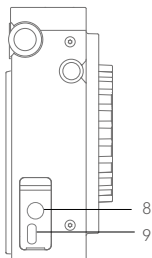
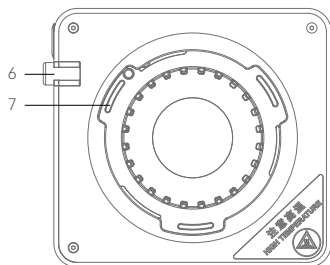
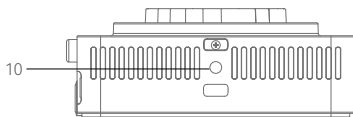
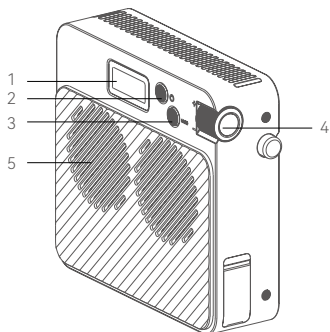

## Item List for ML100Bi

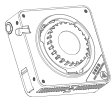

Light Body ×1



Lens Reflector ML-L15 ×1



Holder AD-E2 ×1



Lamp Head Protective Cover ×1



Adapter ×1



AC Power Cord ×1



Instruction Manual ×1

## Item List for ML100Bi(With Carry Bag)



Light Body ×1



Lens Reflector ML-L15 ×1



Holder AD-E2 ×1



Lamp Head Protective Cover ×1



Adapter ×1



AC Power Cord ×1



Storage Bag ×1



Instruction Manual ×1

## Item List for ML100Bi Kit1



Light Body ×1



Lens Reflector ML-L15 ×1



Lens Reflector ML-L36 ×1



Holder AD-E2 ×1



Lamp Head Protective  
Cover ×1



Adapter ×1



AC Power Cord ×1



Power Bank  
Holder PH01 ×1



Mini Tripod MT01 ×1



Storage Bag ×1



Instruction Manual ×1

## Item List for ML100Bi Kit2



Light Body ×1



Lens Reflector  
ML-L15 ×1



Lens Reflector  
ML-L36 ×1



Lamp Head Protective  
Cover ×1



Holder AD-E2  
×1



V-mount Battery  
Accessory Kit AK-B02 ×1



Adapter ×1



AC Power Cord ×1



Storage Bag ×1



Instruction  
Manual ×1

## Item List for ML100Bi Kit3

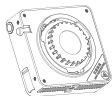

Light Body × 3



Lens Reflector  
ML-L15 × 1



Lens Reflector  
ML-L36 × 1



Lamp Head Protective  
Cover × 3



Holder AD-E2  
× 3



Adapter × 3



AC Power Cord  
× 3



60cm Softbox  
AD-S60S × 1



30cm Diffusion Dome  
ML-CS30 × 1



Light Stand BS-3R-  
FE-190 × 3



Storage Bag × 1



Instruction Manual × 1

## Optional Accessories

Octagon Softbox ML-SF50, Collapsible Lantern Softbox ML-CS30, Lens Reflector ML-L36, Lens Reflector ML-L15, Power Bank Holder PH01, Godox to Bowens Mount Adapter Ring ML-GB

## Power Management

**DC Power Supply** : Connect the adapter to AC power, input 20V $\overline{=}$  6A.

**USB-C Power Supply** : You can separately purchase a charging adapter or power bank, the output of which is determined by the charging adapter or power bank used.

**AK-B02 Power Supply** : You can separately purchase a V-mount battery accessory kit AK-B02 and one 14.8V V-mount battery.

## Installation of the Lamp Head Protective Cover

Align the lamp head protective cover with the Godox mount and insert it. Rotate the lamp head protective cover clockwise until you hear a "click" sound, indicating that the installation is complete.

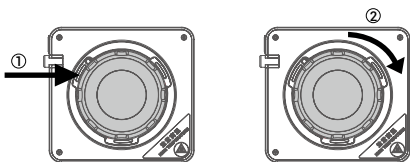

## Removal of the Lamp Head Protective Cover

While pushing the lamp fixture's mount locking pusher, rotate the lamp head protective cover counterclockwise to remove it.

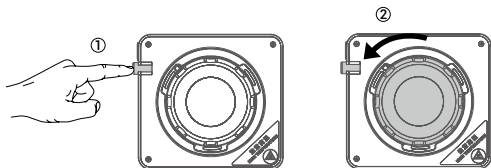

## Installation of the Lens Reflector

Align the lens reflector with the Godox mount on the device and insert it. Rotate the lens reflector clockwise until you hear a "click" sound, indicating that the installation is complete.

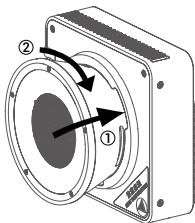

## Removal of the Lens Reflector

While pushing the lamp mount locking pusher, rotate the lens reflector counterclockwise to detach it.

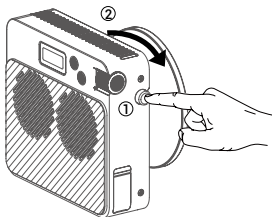

## Power On/Off

After connecting the power supply, continuously press the power switch button to turn the device on or off.

## CCT Mode

Press the MODE/  button briefly to switch modes. When the display screen shows "CCT," it indicates that the current mode is the color temperature mode. Press the select dial briefly to select between CCT/Brightness. When selecting CCT, scroll the select dial to adjust the CCT value. Scroll up once to increase CCT by 100k, and scroll down once to decrease CCT by 100k. The CCT range is from 2800K to 6500K. When selecting brightness, scroll the select dial to adjust the brightness value. Scroll up once to increase the brightness by 1%, and scroll down once to decrease the brightness by 1%. The brightness range is from 0% to 100%.











## FX Mode

Press the MODE/  button briefly to switch modes. When the display shows "FX," it indicates that the current mode is the FX Mode. Press the select dial briefly to select lighting effects/lighting effect parameters/brightness.

When selecting lighting effects, scroll the select dial to choose from the 11 available lighting effect types. When selecting lighting effect parameters, scroll the select dial to adjust specific lighting effect parameters within the range specified in the table below.

When selecting brightness, scroll the select dial to adjust the brightness value. Scroll up once to increase the brightness by 1%, and scroll down once to decrease the brightness by 1%. The brightness range is from 0% to 100%.

## FX Table

No.	FX Icon	FX Type	Option	Adjustable Range
1		FLASH	SPD	1-100
2		LIGHTNING	FREQ	RANDOM/2-20
3		CLOUDY	SPD	RANDOM/1-100
4		BROKEN BULB	SPD	1-100
5		TV	SPD	1-100
6		CANDLE	SPD	1-100
7		FIRE	SPD	1-100
8		FIREWORKS	SPD	1-100
9		EXPLOSION	SPD	1-100
10		WELDING	SPD	1-100
11	<b>SOS</b>	SOS	CCT	2800K-6500K

## Bluetooth Settings

Continuously press the MODE/  button to enter the Bluetooth settings. Scroll the select dial to select Bluetooth Reset (RESET)/Bluetooth On (ON)/ Bluetooth Off (OFF).

**Bluetooth Reset (RESET):** Select Bluetooth Reset (RESET), then press the select dial briefly to perform a Bluetooth reset. After the reset is complete, it will automatically return to the main interface.

**Bluetooth On (ON):** After Bluetooth is turned on, you can use the "Godox Light" app to connect to the light body.

**Bluetooth Off (OFF):** After Bluetooth is turned off, the "Godox Light" app cannot connect to the light body. Scan the QR code below to download the "Godox Light" app (compatible with both Android and iOS systems).

Note: The first mobile device (phone or tablet) can directly control the light body using the app. When switching to another mobile device, the light body needs to be Bluetooth reset before the app can be used. The app needs to be upgraded to version 3.0 or above.





## Low Battery Warning

Please power the device with an external battery pack through DC port. When the battery level is below one green bar, the display screen will automatically show a low battery symbol.



## High Temperature Warning

When the top of the display shows , it indicates that the lamp bead temperature is too high. It is recommended to pause usage until the display screen no longer shows , and then you can resume using the light.

When the full screen of the display shows , it indicates that the light body temperature is too high. The light fixture will automatically activate the light-off function. Once the temperature of the light beads returns to normal, the light fixture will resume normal operation.



## Photometric Data

CCT	Test Condition	Unit	1m	2m	3m
2800K	Bare Light	lux	≈ 2580	≈ 682	≈ 316
		fc	≈ 239	≈ 63	≈ 29
	Lens Reflector ML-L15	lux	≈ 24100	≈ 6010	≈ 2800
		fc	≈ 2240	≈ 558	≈ 260
	Lens Reflector ML-L36	lux	≈ 12500	≈ 3140	≈ 1380
		fc	≈ 1160	≈ 292	≈ 128
3200K	Bare Light	lux	≈ 2990	≈ 777	≈ 363
		fc	≈ 278	≈ 72	≈ 34
	Lens Reflector ML-L15	lux	≈ 27900	≈ 7040	≈ 3250
		fc	≈ 2590	≈ 654	≈ 302
	Lens Reflector ML-L36	lux	≈ 14500	≈ 3640	≈ 1610
		fc	≈ 1350	≈ 338	≈ 150
4300K	Bare Light	lux	≈ 3520	≈ 916	≈ 427
		fc	≈ 327	≈ 85	≈ 40
	Lens Reflector ML-L15	lux	≈ 32900	≈ 8350	≈ 3860
		fc	≈ 3060	≈ 776	≈ 359
	Lens Reflector ML-L36	lux	≈ 17100	≈ 4320	≈ 1910
		fc	≈ 1590	≈ 401	≈ 177
5600K	Bare Light	lux	≈ 3670	≈ 953	≈ 446
		fc	≈ 341	≈ 89	≈ 41
	Lens Reflector ML-L15	lux	≈ 34300	≈ 8800	≈ 4040
		fc	≈ 3190	≈ 817	≈ 376
	Lens Reflector ML-L36	lux	≈ 17900	≈ 4480	≈ 1990
		fc	≈ 1660	≈ 416	≈ 185
6500K	Bare Light	lux	≈ 3380	≈ 878	≈ 410
		fc	≈ 314	≈ 82	≈ 38
	Lens Reflector ML-L15	lux	≈ 31200	≈ 8100	≈ 3730
		fc	≈ 2840	≈ 752	≈ 346
	Lens Reflector ML-L36	lux	≈ 16500	≈ 4130	≈ 1830
		fc	≈ 1530	≈ 383	≈ 170

The above data is not absolute values but averages. All the tests mentioned above were conducted at 100% brightness of the light body. Lens reflector ML-L15 is included, while lens Reflector ML-L36 is sold separately.

## Technical Data

Model	ML100Bi
Power Supply	20V $\overline{=}$ 5A
Max. Input Power	$\approx$ 120W
Brightness Range	0%-100%
CRI	Average $\geq$ 97
TLCI	Average $\geq$ 98
CCT	2800-6500K
FX Type	11
Bluetooth Control Distance	Max.30m
Working Environment Temperature	-10°C ~+40°C
Dimension(Excluding lens reflector)	4.80" $\times$ 4.33" $\times$ 1.81"
Net Weight(Excluding lens reflector)	487g

Specifications and data may subject to changes without notice.

## Maintenance

1. To prevent dust buildup affecting performance, please clean the exterior of the device regularly using a soft, damp cloth.
2. This product, except consumables, is supported with a one-year warranty.
3. Unauthorized service will void the warranty. Maintenance of the light must be performed by our authorized maintenance department which can provide original accessories.
4. Unauthorized repairs of this product will void the one-year warranty, and repair fees will be charged for any repairs.
5. If the product had failures or got wet, do not use it until it is repaired by professionals.
6. Changes made to the specifications or designs may not be reflected in this manual.

## FCC Statement

This device complies with part 15 of the FCC Rules. Operation is subject to the following two conditions:

- (1) This device may not cause harmful interference, and
- (2) this device must accept any interference received, including interference that may cause undesired operation.

Any Changes or modifications not expressly approved by the party responsible for compliance could void the user's authority to operate the equipment.

Note: This equipment has been tested and found to comply with the limits for a Class B digital device, pursuant to part 15 of the FCC Rules. These limits are designed to provide reasonable protection against harmful interference in a residential installation.

This equipment generates uses and can radiate radio frequency energy and, if not installed and used in accordance with the instructions, may cause harmful interference to radio communications. However, there is no guarantee that interference will not occur in a particular installation. If this equipment does cause harmful interference to radio or television reception, which can be determined by turning the equipment off and on, the user is encouraged to try to correct the interference by one or more of the following measures:

- Reorient or relocate the receiving antenna.
- Increase the separation between the equipment and receiver.
- Connect the equipment into an outlet on a circuit different from that to which the receiver is connected.
- Consult the dealer or an experienced radio/TV technician for help.

The device has been evaluated to meet general RF exposure requirement.

The device can be used in portable exposure condition without restriction.

## Warning

Operating frequency:2402MHz – 2480MHz (BT)

Maximum EIRP Power: 4.64dBm

## Declaration of Conformity

GODOX Photo Equipment Co.,Ltd. hereby declares that this equipment are in compliance with the essential requirements and other relevant provisions of Directive 2014/53/EU. In accordance with Article 10(2) and Article 10(10), this product is allowed to be used in all EU member states.For more information of DoC, Please click this web link:

**<https://www.godox.com/eu-declaration-of-conformity/>**

The device complies with RF specifications when the device used at 0mm from your body.

## 产品保修

尊敬的用户，本保修卡是申请保修服务的重要凭证，请您配合销售商填写并妥善保管，谢谢！

产品信息	型号	产品条码
用户信息	姓名	联系电话
	通信地址	
销售商信息	名称	
	联系电话	
	通信地址	
	销售日期	
备注		

注：此表应由销售商盖章确认。

### 产品信息

本文件适用于相关《产品保修信息》(见后面说明)所列产品,其他非属此范围的产品或部件(如促销品、赠品及其他出厂后附加的部件等)不在此保修承诺内。

### 保修期

产品及部件的相应保修期按相关的《产品保修信息》执行。保修期自产品首次购买日起算，购买日以购买产品时保修卡登记日期为准。

### 如何获得保修服务

您可直接与产品销售商或授权服务机构联系，也可拨打神牛产品售后服务电话，与我们联系，由我们的服务人员为您安排服务。申请保修时，您应提供有效的保修卡作为保修凭证，方可获得保修。如您不能提供有效的保修卡，则在我们确认产品或部件属于保修范围的情况下，也可以为您提供保修，但这不作为我们的义务。

## 不适用保修情况

如产品存在下列情况，本文件项下的保证和服务将不适用：①产品或部件超过相应保修期；②错误或不当使用、维护或保管导致的故障或损坏，如：不当搬运；非按产品合理预期用途使用；不当插拔外接设备；跌落或外力挤压；接触或暴露于不适当温度、溶剂、酸碱、水浸或潮湿环境；③由非神牛授权机构或人员安装、修理、更改、添加或拆卸造成的故障或损坏；④产品或部件原有识别信息被修改变更或删除；⑤无有效保修卡；⑥使用非合法授权、非标准或非公开发行的软件造成的故障或损坏；⑦因不可抗力或意外事件造成的故障或损坏；⑧其他非因产品本身质量问题导致的故障或损坏。遇上述情况，您应向相关责任方寻求解决，神牛对此不承担任何责任。因非在保修期或保修范围内的部件、附件或软件导致产品不能正常使用的，不是保修范围内的故障。产品使用过程中正常的脱色，磨损和消耗，不是保修范围内的故障。

## 产品保修和服务支持信息

产品的保修期和服务类型按以下《产品保修信息》执行：

产品类别	选件名称	保修期（月）	保修服务类型
部件	电路板	12	客户送修
	电池	3	客户送修
	充电器等带电性能的部件。	12	客户送修
其他	如外壳、保护罩、锁紧装置、包装等。	无	无保修

神牛产品售后服务电话 0755-29609320-8062

## Warranty

Dear customers, as this warranty card is an important certificate to apply for our maintenance service, please fill in the following form in coordination with the seller and safe-keep it. Thank you!

Product Information	Model	Product Code Number
Customer Information	Name	Contact Number
	Address	
Seller Information	Name	
	Contact Number	
	Address	
	Date of Sale	
Note		

Note: This form shall be sealed by the seller.

### Applicable Products

The document applies to the products listed on the Product Maintenance Information (see below for further information). Other products or accessories (e.g. promotional items, giveaways and additional accessories attached, etc.) are not included in this warranty scope.

### Warranty Period

The warranty period of products and accessories is implemented according to the relevant Product Maintenance Information. The warranty period is calculated from the day (purchase date) when the product is bought for the first time, and the purchase date is considered as the date registered on the warranty card when buying the product.

### How to Get the Maintenance Service

If maintenance service is needed, you can directly contact the product distributor or authorized service institutions. You can also contact the Godox after-sale service call and we will offer you service. When applying for maintenance service, you should provide valid warranty card. If you cannot provide valid warranty card, we may offer you maintenance service once confirmed that the product or accessory is involved in the maintenance scope, but that shall not be considered as our obligation.

## Inapplicable Cases

The guarantee and service offered by this document are not applicable in the following cases:

① The product or accessory has expired its warranty period; ② Breakage or damage caused by inappropriate usage, maintenance or preservation, such as improper packing, improper usage, improper plugging in/out external equipment, falling off or squeezing by external force, contacting or exposing to the improper temperature, solvent, acid, base, flooding and damp environments, etc; ③ Breakage or damage caused by non-authorized institution or staff in the process of installation, maintenance, alternation, addition and detachment; ④ The original identifying information of product or accessory is modified, alternated, or removed; ⑤ No valid warranty card; ⑥ Breakage or damage caused by using illegally authorized, nonstandard or non-public released software; ⑦ Breakage or damage caused by force majeure or accident; ⑧ Breakage or damage that could not be attributed to the product itself. Once met these situations above, you should seek solutions from the related responsible parties and Godox assumes no responsibility. The damage caused by parts, accessories and software that beyond the warranty period or scope is not included in our maintenance scope. The normal discoloration, abrasion and consumption are not the breakage within the maintenance scope.

## Maintenance and Service Support Information

The warranty period and service types of products are implemented according to the following Product Maintenance Information:

Product Type	Name	Maintenance Period(month)	Warranty Service Type
Parts	Circuit board	12	Customer sends the product to designated site
	Battery	3	Customer sends the product to designated site
	Electrical parts e.g.battery charger, etc.	3	Customer sends the product to designated site
Other Items	Lamp body, lamp cover, locking device, package, etc.	No	Without warranty

Godox After-sale Service Call +86-755-29609320(8062)