

合格证
QC PASS

Godox



Wechat
Official Account
神牛微信公众号

深圳市神牛摄影器材有限公司

地址: 深圳市宝安区福海街道塘尾社区耀川工业区厂房2栋
电话: 0755-29609320(8062) 传真: 0755-25723423 邮箱: godox@godox.com

GODOX Photo Equipment Co.,Ltd.

Add.: Building 2, Yaochuan Industrial Zone, Tangwei Community,
Fuhai Street, Bao'an District, Shenzhen 518103, China Tel: +86-755-29609320(8062)
Fax: +86-755-25723423 Email: godox@godox.com

www.godox.com

Made in China | 705-WMS200-01

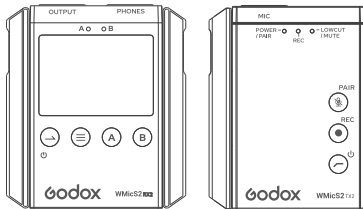

WMicS2

小型UHF无线麦克风系统

UHF Compact Wireless Microphone System

使用手册
Instruction Manual

前言

感谢购买神牛产品!

WMicS2是一款利用UHF波段传输的无线麦克风系统，轻巧耐用的外观设计，稳定精准的强大功能，灵活多变的套装组合，适用于专业室内采访、网络直播、拍短视频、户外采访等场景。

使用本产品之前，请仔细阅读说明书，以便正确操作及使用。

产品特点

- 96个无线频道可选，有效减少热频干扰
- 无线距离最大可达200m
- UHF频率范围：514.56MHz-553.92MHz
- 接收器OLED显示屏提供各项参数设置
- 输出音量控制，提供静音功能，支持实时监听
- 内置锂电池，长效续航
- Kit 2套装标配收纳式充电盒，支持一键配对
- 一个接收器可同时连接两个发射器
- 外置SD卡槽，内置录音，可单独工作成录音笔/器

(注：最大支持频率为514.56MHz-553.92MHz，96个无线频道在此频率范围中选择，会存在部分频率没有利用的情况。)

警告

- △ 麦克风是精密设备。请勿使其掉落或受到撞击，以避免发生故障。
- △ 请勿私自拆卸、改装或尝试维修本产品。产品如出现故障须由本公司或授权的维修人员进行检查维修。
- △ 请保持干燥，请勿用湿手握持本产品，亦不可将产品浸入水中或暴露于雨中。
- △ 请勿将本产品存放在阳光直射的地方、加热装置附近或者炎热、潮湿或多尘的地方。
- △ 请勿让儿童接触本产品，以避免发生意外。
- △ 请勿在易燃易爆环境使用。在这些场合下，请注意相关警告标识。
- △ 请勿放置在超过45度的高温环境中。
- △ 请仔细阅读并遵守由厂商提供的警告或指示。
- △ 如果电池更换不当会有爆炸危险，只能用同样类型或等效类型的电池来更换，仅维修人员可更换，非一般人员更换。
- △ 电池不得暴露在诸如日照，火烤或类似过热环境中。
- △ 消费者若使用电源适配器充电，则应购买配套使用获得CCC认证并满足标准要求的电源适配器。

部件名称

腰包发射器(WMicS2 TX2)

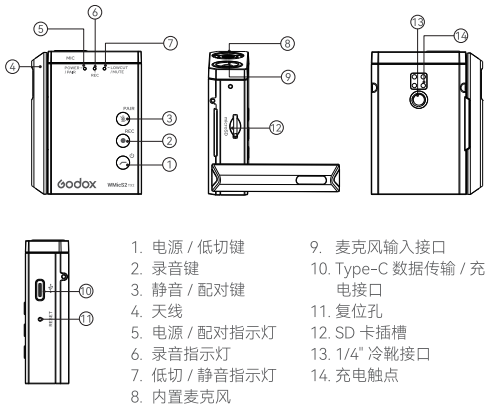

便携接收器 (WMicS2 RX2)

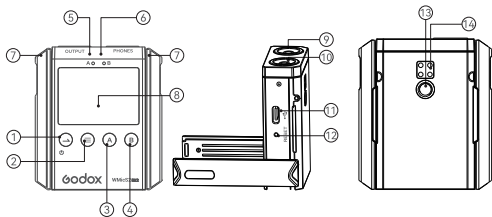

- | | |
|-------------|------------------------|
| 1. 电源键 | 8. OLED 显示屏 |
| 2. 功能 / 确认键 | 9. 3.5mm 音频信号输出接口 |
| 3. A 通道键 | 10. 3.5mm 耳机监听接口 |
| 4. B 通道键 | 11. Type-C 数据传输 / 充电接口 |
| 5. A 通道指示灯 | 12. 复位孔 |
| 6. B 通道指示灯 | 13. 1/4" 冷靴接口 |
| 7. 天线 | 14. 充电触点 |

OLED显示屏:

1. Mono 单通道 / Stereo 立体声
2. 接收器电量
3. A/B 组射频信号 (! 表示未连接成功)
4. A/B 发射器电量
5. A/B 发射器输入音量
6. A/B 组通道 01-48

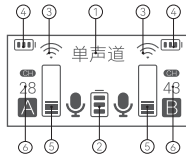

UHF充电盒(WM-C)

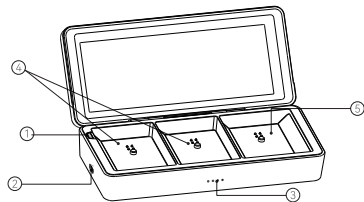

- | | | |
|----------|---------------|----------|
| 1. 一键配对键 | 2. Type-C 充电口 | 3. 电源指示灯 |
| 4. 发射器凹槽 | 5. 接收器凹槽 | |

标配物品

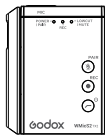

① 腰包发射器 WMicS2 TX2



② 便携接收器 WMicS2 RX2



③ UHF 充电盒 WM-C

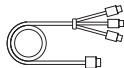

④ Type-C 转 USB
数据线

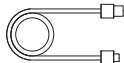

⑤ Type-C 转 USB
数据线

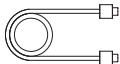

⑥ Type-C 转 Type-C
数据线



⑦ 防风毛罩



⑧ 铁线背夹



⑨ 磁铁领夹

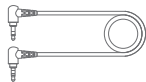

⑩ 3.5mm TRS 转 TRRS
连接线

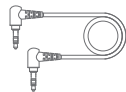

⑪ 3.5mm TRS 转 TRS
连接线

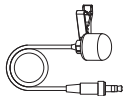

⑫ 全向型领夹式麦克风
LMS-12B AXL



⑬ 手提绳



⑭ 皮质收纳袋



⑮ 说明书

名称	型号	标配物品
腰包发射器	WMicS2 TX2	① ×1、⑤ ×1、⑦ ×1、⑧ ×1、 ⑨ ×1、⑫ ×1、⑮ ×1
便携接收器	WMicS2 RX2	② ×1、⑤ ×1、⑧ ×1、⑨ ×1、 ⑩ ×1、⑪ ×1、⑮ ×1
UHF 充电盒	WM-C	③ ×1、⑤ ×1、⑬ ×1、⑮ ×1
小型 UHF 无线麦克风系统组合一	WMicS2 Kit 1	① ×1、② ×1、④ ×1、⑥ ×1、 ⑦ ×1、⑧ ×2、⑨ ×2、⑩ ×1、 ⑪ ×1、⑫ ×1、⑭ ×1、⑮ ×1
小型 UHF 无线麦克风系统组合二	WMicS2 Kit 2	① ×2、② ×1、③ ×1、④ ×1、 ⑥ ×1、⑦ ×2、⑧ ×3、⑨ ×3、 ⑩ ×1、⑪ ×1、⑫ ×2、⑬ ×1、 ⑮ ×1

使用说明

腰包发射器

1.开关机

长按2秒电源/低切键即可开/关机，开机后电源/配对指示灯长亮绿色。

2.低切

短按电源/低切键即可开启低切功能，低切/静音指示灯亮黄色。

3.录音备份

发射器插入外置TF卡，短按录音键进入录制模式，音频文件会自动备份，录音指示灯长亮红色，再次短按录音键录制结束，录音指示灯灭。使用Type-C数据后，短按电源/低切键，进入电脑储存模式，对录制的音频文件进行回放，监听声音质量。

注：录制的文件为 WAV 格式，录音功能触发一次为一个文件。

录音文件存储规则：音频文件默认30分钟时长为一个文件，不够30分钟按一个文件存储，超过30分钟自动跳转到下个文件内存储，当开始录制到结束录制以30分钟的倍数叠加存储。

4. 静音

短按静音/配对键开启静音模式，低切/静音指示灯亮红色，接收器显示静音图标，再次短按即可退出静音模式。

5. 配对

长按静音/配对键3秒，接收机屏幕显示“正在配对”，此时发射机接收到信息开始配对，电源/配对指示灯显示蓝黄交替灯，配对成功长亮绿色。

6. 电脑触发存储

使用Type-C数据线红色接口连接电脑后，短按电源/低切键，电脑识别存储功能，弹出U盘。

7. Type-C接口充电

通过Type-C接口连接数据线，默认进入充电模式，开机充电时电源/配对指示灯长亮黄色；关机充电时为红色闪烁，充满电后长亮蓝色。

注：在充电期间机器可以正常工作，录音备份不受影响。正在录音或手机同步音频时不能进行USB文件读写，USB连接电脑可进行充电，但电脑文件管理里不会出现U盘文件，要退出录音或手机同步音频后U盘文件读卡功能才会自动激活。

8. 指示灯说明

- 8.1 正常开机未配对时电源/配对指示灯长亮绿色；
- 8.2 配对过程中电源/配对指示灯呈蓝黄交替，配对成功长亮绿色；
- 8.3 录音时录音指示灯长亮红色，录制结束指示灯熄灭；
- 8.4 静音后低切/静音指示灯长亮红色；
- 8.5 开启低切功能后低切/静音指示灯长亮黄色；
- 8.6 发射器电量低于10%时指示灯状态：
 - 8.6.1 配对成功/不成功时电源/配对指示灯长亮红色；
 - 8.6.2 配对成功/不成功时录音，电源/配对指示灯和录音指示灯均长亮红色；
 - 8.6.3 配对成功/不成功时录音并打开低切，电源/配对指示灯和录音指示灯均长亮红色，低切/静音指示灯长亮黄色；
 - 8.6.4 配对成功/不成功时录音并静音，电源/配对指示灯、录音指示灯和低切/静音指示灯均长亮红色；
- 8.7 插入适配电源指示灯显示；
 - 8.7.1 开机充电时电源/配对指示灯长亮黄色，关机充电时电源/配对指示灯红色闪烁，充满电后灯灭；
 - 8.7.2 开机后录音，电源/配对指示灯长亮黄色，录音指示灯长亮红色；
 - 8.7.3 开机后录音时打开低切，电源/配对指示灯长亮黄色，录音指示灯长亮红色，低切/静音指示灯长亮黄色；

8.7.4 开机后录音时静音, 电源/配对指示灯长亮黄色, 录音指示灯和低切/静音指示灯长亮红色。

便携接收器

1. 开关机

长按2秒电源/低切键即可开/关机, 开机后电源/配对指示灯长亮绿色。

2. 语言选择

首次开机自动进入语言界面, 短按A/B键进入语言选择, 短按功能/确认键确认语言, 下次开机自动识别关机前语言。A/B键同时长按4秒, 自动跳转到重置界面, 重置成功后原先数据清除, 再次开机后重新自动跳转到语言选择界面。

3. 配对

长按A/B键2秒, 屏幕显示A/B通道的图标虚拟闪烁, 识别其他发射机并自动配对(识别过程中屏幕出现“正在配对”字样), 配对成功屏幕出现“配对成功”字样并返回主界面, 此时A/B通道指示灯长亮



(A组配对成功, B组未配对)

绿色、屏幕中A/B发射器电量图标显示实时电量、“CH”图标下显示通道数、A/B通道图标变为实心、A/B发射器输入音量显示实时音量; 配对不成功显示为“配对失败”并返回主界面。

4. 通道设置

短按A/B键, 屏幕显示A/B组通道数(01-48), 然后长按A/B键令需要设置的通道数闪烁, 再短按A通道键减少通道数, 短按B通道键增加通道数, 最后短按功能/确认键确认通道设置。



5. 音量设置

短按A/B键, 屏幕显示A/B组音量数(01-10), 然后长按A/B键令需要设置的音量数闪烁, 再短按A通道键减少音量, 短按B通道键增加音量, 最后短按功能/确认键确认音量设置。



6. 声音通道设置

短按A/B键, 屏幕显示声音通道(单声道/立体声), 然后长按功能/确认键令黄色文字闪烁, 再短按A/B通道键切换单声道/立体声, 最后短按功能/确

认键确认声音通道设置。或者在主界面同时短按A/B通道键,可切换单声道/立体声。

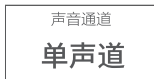

7.屏幕亮度设置

短按A/B键,屏幕显示屏幕亮度(1-8),然后长按功能/确认键令数字闪烁,再短按A通道键减少亮度,短按B通道键增加亮度,最后短按功能/确认键确认亮度设置。



8.屏幕休眠设置

短按A/B键,屏幕显示屏幕休眠时间(10S/30S/60S),然后长按功能/确认键令数字闪烁,再短按A通道键减少屏幕休眠时间,短按B通道键增加屏幕休眠时间,最后短按功能/确认键确认屏幕休眠设置。



9.屏幕翻转

长按功能/确认键,可实现屏幕翻转。

10.指示灯说明

正常开机后屏幕显色。A/B组配对成功后,A/B通道指示灯长亮绿色,断开连接后指示灯熄灭。

UHF充电盒

1.一键配对键

当发射器/接收器充满电一天后,发射器/接收器进入深度休眠状态,拿起机器不能开机工作,放入盒中短按一键配对键即可唤醒发射器/接收器。长按一键配对键3秒,发射器/接收器实现一键配对功能。

2.电源指示灯(4颗)

充电盒自身充电:指示灯亮绿色,按充电量递增,充满时变为4颗灯长亮。
为发射器/接收器充电:指示灯亮绿色,按充电量递减。

安装说明

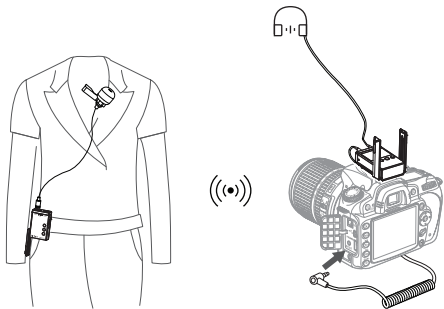

17

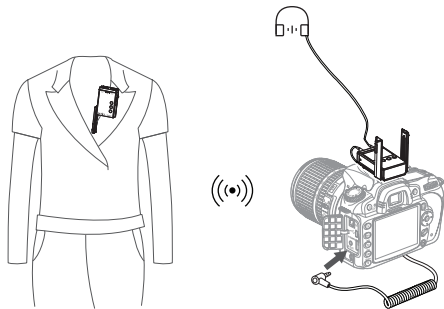

18

发射器

- ① 将全向型领夹式麦克风插入发射器的“MIC”接口；
- ② 打开发射器，设置相应参数；
- ③ 用铁线背夹将发射器夹在腰带上，或用磁铁领夹将其夹在衣领或袖口上，或将其直接放进口袋里。

注：使用磁铁领夹将发射器夹在衣领上时，可选择不用领夹式麦克风，而直接对准发射器内置麦克风说话。

接收器

- ① 将1/4"冷靴连接到接收器，并将其安装在相机/摄影设备上；
- ② 将3.5mm插头音频线的一端插入接收器的“OUTPUT”接口，另一端插入相机的“MIC”接口；
- ③ 打开接收器，设置相应参数。

注意：设置参数时，需将发射器与接收器设置相同的组别和频道；一个接收器连接两个发射器使用时，必须 A 发射器设置在 A 组别使用，B 发射器设置在 B 组别使用。

规格参数

名称	腰包发射器	便携接收器	UHF充电盒
型号	WMicS2 TX2	WMicS2 RX2	WM-C
频道组	A/B	A/B	/
频道数	96(A组48; B组48)	96(A组48; B组48)	/
RF频率范围	514.56MHz-553.92MHz	514.56MHz-553.92MHz	/
音频频率范围	40Hz-18KHz	40Hz-18KHz	/
声音延迟	12ms	12ms	/
音频输入接口	3.5mm	3.5mm	/
锂电池容量	770mAh	770mAh	10000mAh
Type-C输入参数	5V/0.4A	5V/0.4A	5V/2A(Max.)
工作环境温度	-10°C~45°C	-10°C~45°C	-10°C~45°C
接收距离	无障碍接收距离200m, 有障碍接收距离60m	无障碍接收距离200m, 有障碍接收距离60m	/
信噪比	≈70dB	≈70dB	/
接收灵敏度	/	-95dBm	/
失真	/	小于3%	/

尺寸	65.8X50.4X20.5mm (天线长65mm)	65.8X58.4X20.5mm (天线长65mm)	185.8x84.2x 42mm
净重	57g	66g	367g

*规格和参数如有变更，恕不另行通知。

故障排除

- 如不能接收到音频信号，请检查电池是否正确安装以及是否打开发射器电源；发射器和接收器是否设置在同一组别和频道；麦克风及耳机是否已正确牢固连接到位；功能模式是否设置正确。
- 检查发射器是否设置的静音。
- 如您的发射器受到他人干扰，改变发射器和接收器的频道设置即可。
- 如您发现发射音频距离有限或者有漏发现象，请检查是否电池耗尽，请及时充电。

维护保养

避免跌落：如果受到强烈碰撞或振动，发射器和接收器可能会发生故障。

保持干燥：本产品是非防水产品，如果将其浸入水中或放置于高湿度的环境中将可能发生故障。内部构造生锈可能会导致无法修理的损害。

避免温度骤变：温度的突变，诸如在寒冷天进出温暖的大楼将可能会使发射器和接收器内部结露。为避免结露，请将发射器和接收器事先装入手提袋或塑料包内，以防温度突变。

远离强磁场：无线电广播发射机等设备产生的强静电或强磁场可能会干扰本产品正常工作。

1年保修，消耗品如领夹麦克风等，不在1年保修范围。

如有技术更改，恕不另行通知。

Forward

Thank you for purchasing!

WMicS2 is a UHF compact wireless microphone system, the evolution and upgradation of S1 system. With the addition of charging case and upgradation of various functions, it provides a satisfying experience for live streaming, interview, video recording, journalistic shooting, audio recording, etc.

Please read this manual carefully before using to make sure the correct operation and exert the optimum function.

Main Features

- 96 wireless channels freely switchable without interference.
- The maximum wireless distance up to 200m.
- UHF Frequency Range: 514.56MHz-553.92MHz.
- With OLED display on transmitter to show the parameters setting.
- Provide output volume control and silent function, support real-time monitoring.
- Built-in chargeable lithium battery.
- Kit 2 includes charging case which provides both charging and storage functions.

- Support two transmitters and one receiver to work simultaneously.
- External SD card slot and internal recording function make it a voice recorder individually.

(Note: as the max. support frequency is 514.56MHz-553.92MHz which includes the 96 wireless channel's frequency, there are parts of frequency may not be utilized.)

Warning

- △ Do not disassemble. Should repairs become necessary, this product must be sent to an authorized maintenance center.
- △ Always keep this product dry. Do not use in rain or in damp conditions.
- △ Keep out of reach of children.
- △ Do not use the flash unit in the presence of flammable gas. In certain circumstance, please pay attention to the relevant warnings.
- △ Do not leave or store the product if the ambient temperature reads over 45°C.
- △ Read and understand all instructions before using.
- △ Changes made to the specifications or designs may not be reflected in this manual.

Names of Parts

Body-pack Transmitter (WMicS2 TX2)

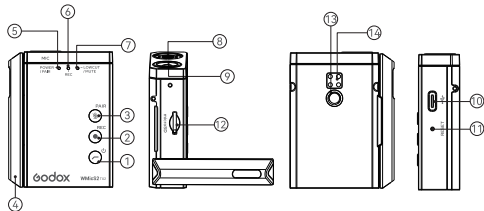

- | | |
|--------------------------------|--|
| 1. Power Switch/Lowcut Button | 9. Mic Input Port |
| 2. Record Button | 10. Type-C Data Transmitting/
Charging Port |
| 3. Mute/Pair Button | 11. Reset Hole |
| 4. Antenna | 12. SD Card Slot |
| 5. Power Switch/Pair Indicator | 13. 1/4" Coldshoe Mount Port |
| 6. Record Indicator | 14. Charging Points |
| 7. Lowcut/Mute Indicator | |
| 8. Built-in Mic | |

Portable Receiver (WMicS2 RX2)

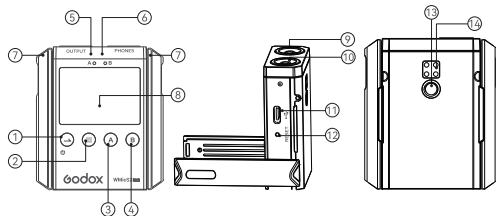

- | | |
|----------------------------|--|
| 1. Power Switch Button | 9. 3.5mm Audio Output Port |
| 2. Function/Confirm Button | 10. 3.5mm Earphone Monitoring Port |
| 3. A Group Button | 11. Type-C Data Transmitting/
Charging Port |
| 4. B Group Button | 12. Reset Hole |
| 5. A Group Indicator | 13. 1/4" Coldshoe Mount Port |
| 6. B Group Indicator | 14. Charging Points |
| 7. Antenna | |
| 8. OLED Display | |

OLED Display:

1. Mono/Stereo Mode
2. Receiver Battery Level Indicator
3. A/B Group Frequency Signal
(! indicates Disconnection)
4. A/B Transmitter Battery Level Indicator
5. A/B Transmitter Input Volume
6. A/B Group Channel 01-48

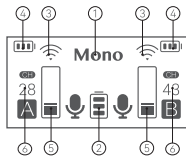

UHF Charging Case (WM-C)

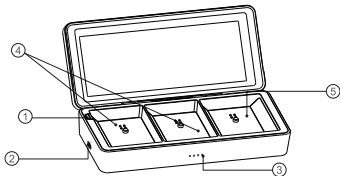

1. Pair Button
2. Type-C Charging Port
3. Power Indicators
4. Transmitter Slot
5. Receiver Slot

Included Items

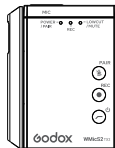

① Body-pack Transmitter
(WMicS2 TX2)



② Portable Receiver
(WMicS2 RX2)



③ UHF Charging Case
(WM-C)

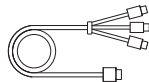

④ Type-C to USB Cable

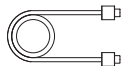

⑤ Type-C to USB Cable

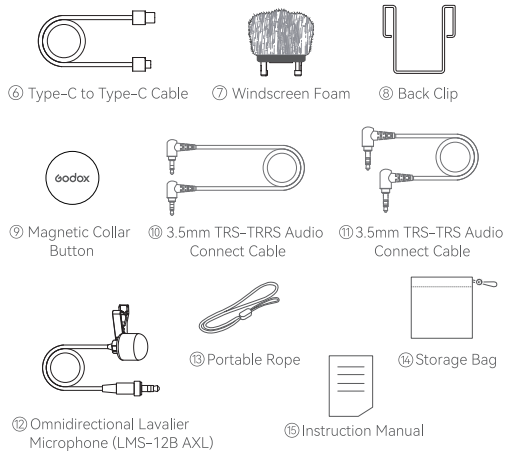

Name	Model	Included Items
Body-pack Transmitter	WMicS2 TX2	① ×1, ⑤ ×1, ⑦ ×1, ⑧ ×1, ⑨ ×1, ⑫ ×1, ⑮ ×1
Portable Receiver	WMicS2 RX2	② ×1, ⑤ ×1, ⑧ ×1, ⑨ ×1, ⑩ ×1, ⑪ ×1, ⑮ ×1
UHF Charging Case	WM-C	③ ×1, ⑤ ×1, ⑬ ×1, ⑮ ×1
UHF Compact Wireless Microphone System Kit1	WMicS2 Kit 1	① ×1, ② ×1, ④ ×1, ⑥ ×1, ⑦ ×1, ⑧ ×2, ⑨ ×2, ⑩ ×1, ⑪ ×1, ⑫ ×1, ⑭ ×1, ⑮ ×1
UHF Compact Wireless Microphone System Kit2	WMicS2 Kit 2	① ×2, ② ×1, ③ ×1, ④ ×1, ⑥ ×1, ⑦ ×2, ⑧ ×3, ⑨ ×3, ⑩ ×1, ⑪ ×1, ⑫ ×2, ⑬ ×1, ⑮ ×1

Operation Instruction

Body-pack Transmitter

1.Power Switch

Long press the Power Switch/Lowcut Button to power on or off the transmitter, the Power Switch/Pair Indicator will be constant on green after turned on.

2.Lowcut

Short press the Power Switch/Lowcut Button to turn on lowcut function, the Lowcut/Mute Indicator will be constant on yellow.

3.Recording Backup

Insert an external TF card into the transmitter, short press the Record Button to enter recording mode, the audio files will be automatically backed up and the Record Indicator will be constant on red. Short press the Record Button again to stop recording, then the Record Indicator will be off. Connect it to the computer with Type-C data cable, short press the Power Switch/Lowcut Button to enter the computer storage mode, user can play back and monitor the recorded audio files.

Note: The recorded audio files are in WAV format, and there will be one file stored when the recording function is triggered once.

Recorded files storage rules: The default duration of an audio

files is 30 minutes. In case of less than 30 minutes, it will still be stored as one file. If it exceeds 30 minutes, the exceeded part will automatically be stored as another file.

4.Mute

Short press the Mute/Pair Button to switch to mute mode, the Lowcut/Mute Indicator will be constant on red, the receiver's OLED display shows mute icon, short press it again to exit mute mode.

5.Pair

Long press the Mute/Pair Button for 3 seconds, the receiver's OLED display shows "Matching", then the transmitter starts matching, the Power Switch/Pair Indicator blinks blue and yellow, turns to be constant on green after pair success.

6.Computer-triggered Storage

Short press the Power Switch/Lowcut Button after connecting to the computer with red port of Type-C data cable, the computer will recognize the storage function and eject the U disk.

7.Charging through Type-C port

When charging through Type-C data cable, the Power Switch/Pair Indicator will be constant on yellow in power on status, while blinks red and then constant on blue after fully charged in power off status.

Note: The transmitter works normally during charging without affecting the recording backup. USB file reading and writing is not available when recording or synchronizing audio with mobile phone. Connect to the computer through USB port can only charge the transmitter, but the U disk file will not appear in the computer file management until exiting recording or synchronizing audio with mobile phone.

8.Indicator Instruction

- 8.1 The Power Switch/Pair Indicator will be constant on green when it is powered on but unpaired.
- 8.2 The Power Switch/Pair Indicator will blink blue and yellow during pairing, and turn to be constant on green after pairing success.
- 8.3 The Record Indicator will be constant on red when recording, and off when stop recording.
- 8.4 The Lowcut/Mute Indicator will be constant on red in mute mode.
- 8.5 The Lowcut/Mute Indicator will be constant on yellow in lowcut mode.
- 8.6 Indicator status when the transmitter battery is lower than 10%:
 - 8.6.1 When the pairing is successful/unsuccessful, the Power Switch/Pair Indicator will be constant on red.
 - 8.6.2 Record when pairing is successful/unsuccessful, the Power Switch/Pair Indicator and the Record Indicator will be constant on red.

8.6.3 Record and turn on the lowcut function when the pairing is successful/unsuccessful, the Power Switch/Pair Indicator and the Record Indicator will be constant on red, and the Lowcut/Mute Indicator will be constant on yellow.

8.6.4 Record and mute when pairing is successful/unsuccessful, the Power Switch/Pair Indicator, Record Indicator and Lowcut/Mute Indicator will be constant on red.

8.7 Indicator status when plugging in the power adapter:

8.7.1 The Power Switch/Pair Indicator will be constant on yellow when charging in power on status, while blinks red when charging in power off status, and turn off after fully charged.

8.7.2 Record in power on status, the Power Switch/Pair Indicator will be constant on yellow, and the Record Indicator will be constant on red.

8.7.3 Record and turn on the lowcut function in power on status, the Power Switch/Pair Indicator will be constant on yellow, the Record Indicator will be constant on red, and the Lowcut/Mute Indicator will be constant on yellow.

8.7.4 Record and mute in power on status, the Power Switch/Pair Indicator will be constant on yellow, the Record Indicator and Lowcut/Mute Indicator will be constant on red.

Portable Receiver (WMicS2 RX2)

1.Power Switch

Long press the Power Switch Button for 2 seconds to power on/off, the OLED display will light on.

2. Language Setting

The receiver will automatically enter the language setting interface when turned on for the first time, short press the A/B Group Button to enter language selection, short press the Function/Confirm Button to confirm the language, it will automatically show the saved language afterwards. Press and hold the A/B Group Button for 4 seconds at the same time to automatically reset and clear the original data, then it will automatically enter the language setting interface after restarting.

3. Pairing

Long press the A/B Group Button for 2 seconds, the A/B icon blinks in dashed box on the OLED display, it will automatically recognize transmitters and start pairing with "pairing" appears on the display. If the



(group A is paired and group B is unpaired)

Pairing is successful, "Pairing ok" appears on the display and returns to the main interface, then the A/B Group Indicator be constant on green, A/B Transmitter Battery Level Indicator displays the real-time battery level, channel No. displays under the "CH" icon, A/B Group

A/B Group icon turns into solid box, A/B Transmitter Input Volume icon displays real-time volume. If the Pairing is unsuccessful, "Pairing fail" appears on the display and returns to the main interface.

4. Channel Setting

Short press the A/B Group Button, the display shows the A/B group channel No. (01-48), long press the A/B Group Button to make the adjusted channel No. blinks, then short press the A Group Button can decrease channel No., while short press the B Group Button can increase channel No., finally short press the Function/Confirm Button to confirm the channel setting.



5. Volume Setting

Short press the A/B Group Button, the display shows the volume No. of A/B group (01-10), long press the A/B Group Button to make the adjusted No. blinks, then short



press the A Group Button can decrease the volume, while short press the B Group Button can increase the volume, finally short press the Function/Confirm Button to confirm the volume setting.

6. Output Mode Setting

Short press the A/B Group Button, the display shows the output mode (Mono/Stereo), long press the Function/Confirm Button to make the yellow icon blinks, then short press the A/B Group Button to switch between mono and stereo mode, finally short press the Function/Confirm Button to confirm the output mode setting. Short press the A/B Group Button at the same time on the main interface can also switch between mono and stereo mode.



7. OLED Light Setting

Short press the A/B Group Button, the display shows the OLED light (1-8), long press the Function/Confirm Button to make



the number blinks, then short press the A Group Button can decrease the light, short press the B Group Button can increase the light, finally short press the Function/Confirm Button to confirm the light setting.

8. Screen Dormancy

Short press the A/B Group Button, the display shows the screen dormancy time (10S/30S/60S), long press the Function/Confirm Button to make the number blinks, then short press the A Group Button can decrease the screen dormancy time, short press the B Group Button can increase the screen dormancy time, finally short press the Function/Confirm Button to confirm the screen dormancy setting.



9. Screen Rotate

Long press the Function/Confirm Button can rotate the screen.

10. Indicator Instruction

The OLED display will light on after powered on. If the A/B group is

paired successfully, the corresponding indicator will be constant on green, and turn off after disconnected.

UHF Charging Case (WM-C)

1. Pair Button

The transmitter/receiver will enter deep sleep after fully charged for one day, and cannot be turned on when you pick it up, it needs to be put into the charging case and press the Pair Button to wake up. Long press the Pair Button for 3 seconds, the transmitter/receiver will automatically start pairing.

2. Power Indicators (4)

Self-charging: the Power Indicators will blink green increasingly, and all be constant on green after fully charged.

Charging the transmitter/receiver: the Power Indicators will be constant on green when charging the transmitter/receiver, decreasing along with its battery level.

Installation Instruction

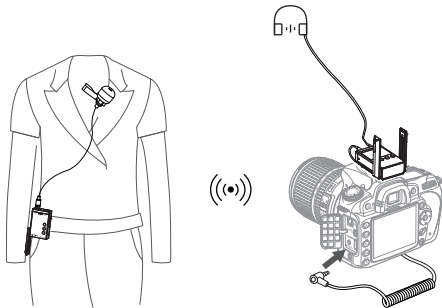

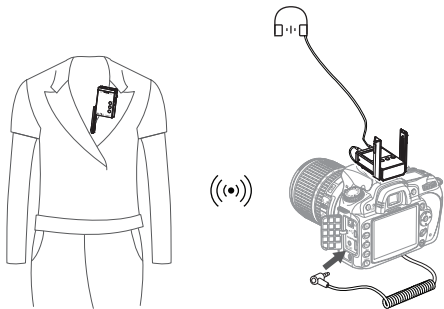

Transmitter

- ① Insert the omnidirectional lavalier microphone into the transmitter's MIC port.
- ② Turn on the transmitter to set the relevant parameters.
- ③ Clip the transmitter onto the belt, collar, sleeve or put it into your pocket.

Note: When clipping the transmitter on the collar with magnetic collar button, you can speak directly at the built-in mic without using the omnidirectional lavalier microphone.

Receiver

- ① Connect the 1/4 " cold shoe onto the receiver, and install them on the camera or shooting equipment.
- ② Insert one end of the 3.5mm cable into the receiver's OUTPUT port and the other end into camera's MIC port.
- ③ Turn on the transmitter to set the relevant parameters.

Note: Please set the group and channels of transmitter and receiver to the same when setting parameters. When a receiver is connecting to two transmitters, A transmitter must be set and used in A group while B transmitter must be set and used in B group.

Technical Data

Product Name	Body-pack Transmitter	Portable Receiver	UHF Charging Case
Model	WMicS2 TX2	WMicS2 RX2	WM-C
Group	A/B	A/B	/
Channel	96(Group A: 48; Group B: 48)	96(Group A: 48; Group B: 48)	/
RF Frequency Range	514.56MHz- 553.92MHz	514.56MHz- 553.92MHz	/
Audio Frequency Range	40Hz-18KHz	40Hz-18KHz	/
Sound Delay	12ms		/
Audio Input Port	3.5mm	12ms	/
Lithium Battery Capacity	770mAh	3.5mm 770mAh	10000mAh
Type-C Input Parameters	5V/0.4A		5V/2A(Max.)

Working Temperature Range	-10°C~45°C	-10°C~45°C	-10°C~45°C
Receiving Distance	Barrier-free receiving distance: 200m, Barriered receiving distance: 60m	Barrier-free receiving distance: 200m, Barriered receiving distance: 60m	/
Signal Noise Ratio	≈70dB	≈70dB	/
Receive Sensitivity	/	-95dBm	/
Distortion	/	Below 3%	/
Dimension	65.8X50.4X20.5mm (Antenna length: 65mm)	65.8X58.4X20.5mm (Antenna length: 65mm)	185.8X84.2 x42mm
Net Weight	57g	66g	367g

* Specifications and data may subject to changes without notice.

Troubleshooting

- Unable to receive audio signal. Make sure batteries are installed correctly and Power Switch is turned on. Check if the transmitter and the receiver are set to the same channel, if the microphone or earphone is well connected, or if the devices are set to the correct mode.
- Check if the transmitter is set to mute mode or not.
- Signal disturbance or shooting interference. Change a different channel of the transmitter and receiver.
- Operating audio distance limited or signal missing. Check if batteries are exhausted. If so, replace them.

Maintenance

- Avoid sudden drops. The device may fail to work after strong shocks, impacts, or excess stress.
- Keep dry. The product isn't water-proof. Malfunction, rust, and corrosion may occur and go beyond repair if soaked in water or exposed to high humidity.
- Avoid sudden temperature changes. Condensation happens if sudden temperature changes such as the circumstance when taking the transmitter and receiver out of a building with higher temperature to outside in winter. Please put the transmitter and receiver in a handbag or plastic bag beforehand.
- Keep away from strong magnetic field. The strong static or magnetic field produced by devices such as radio transmitters leads to malfunction.
- Unauthorized service will void the warranty.
- If the product had failures or was wetted, do not use it until it is repaired by professionals.
- Changes made to the specifications or designs may not be reflected in this manual.

FCC Caution

This device complies with part 15 of the FCC Rules. Operation is subject to the following two conditions:

- (1) This device may not cause harmful interference, and
- (2) this device must accept any interference received, including interference that may cause undesired operation.

Any Changes or modifications not expressly approved by the party responsible for compliance could void the user's authority to operate the equipment.

Note: This equipment has been tested and found to comply with the limits for a Class B digital device, pursuant to part 15 of the FCC Rules. These limits are designed to provide reasonable protection against harmful interference in a residential installation. This equipment generates uses and can radiate radio frequency energy and, if not installed and used in accordance with the instructions, may cause harmful interference to radio communications. However, there is no guarantee that interference will not occur in a particular installation. If this equipment does cause harmful interference to radio or television

reception, which can be determined by turning the equipment off and on, the user is encouraged to try to correct the interference by one or more of the following measures:

- Reorient or relocate the receiving antenna.
- Increase the separation between the equipment and receiver.
- Connect the equipment into an outlet on a circuit different from that to which the receiver is connected.
- Consult the dealer or an experienced radio/TV technician for help.

The device has been evaluated to meet general RF exposure requirement.

The device can be used in portable exposure condition without restriction.

Warning

Operating frequency:514.56MHz-553.92MHz
Maximum ERP Power: -9.45dBm

Declaration of Conformity:

GODOX Photo Equipment Co.,Ltd. hereby declares that this equipment are in compliance with the essential requirements and other relevant provisions of Directive 2014/53/EU. In accordance with Article 10(2) and Article 10(10), this product is allowed to be used in all EU member states.For more information of DoC, Please click this web link:
https://www.godox.com/DOC/Godox_WMicS2_Series_DOC.pdf.
The device complies with RF specifications when the device used at 0mm from your body.

产品保修

尊敬的用户，本保修卡是申请保修服务的重要凭证，请您配合销售商填写并妥善保管，谢谢！

产品信息	型号	产品条码
用户信息	姓名	联系电话
	通信地址	
销售商 信息	名称	
	联系电话	
	通信地址	
	销售日期	
备注		

注：此表应由销售商盖章确认。

适用产品

本文件适用于相关《产品保修信息》(见后面说明)所列产品, 其他非属此范围的产品或部件(如促销品、赠品及其他出厂后附加的部件等)不在此保修承诺内。

保修期

产品及部件的相应保修期按相关的《产品保修信息》执行。保修期自产品首次购买日起算, 购买日以购买产品时保修卡登记日期为准。

如何获得保修服务

要保修服务, 您可直接与产品销售商或授权服务机构联系, 也可拨打神牛产品售后服务电话, 与我们联系, 由我们的服务人员为您安排服务。申请保修时, 您应提供有效的保修卡作为保修凭证, 方可获得保修。如您不能提供有效的保修卡, 则在我们可确认产品或部件属于保修范围的情况下, 也可以为您提供保修,但这不作为我们的义务。

不适用保修的情况

如产品存在下列情况, 本文件项下的保证和服务将不适用 ① 产品或部件超过相应保修期; ② 错误或不当使用、维护或保管导致的故障或损坏, 如: 不当搬运; 非按产品合理预期用途使用; 不当插拔外接设备; 跌落或外力挤压; 接触或暴露于不适当温度、溶剂、酸碱、水浸或潮湿环境; ③ 由非神牛授权机构或人员安装、修理、更改、添加或拆卸造成的故障或损坏; ④ 产品或部件原有识别信息被修改变更或删除; ⑤ 无有效保修卡; ⑥ 使用非合法授权、非标准或非公开发行的软件造成的故障或损坏; ⑦ 因不可抗力或意外事件造成的故障或损坏; ⑧ 其他非因产品本身质量问题导致的故障或损坏。遇上述情况, 您应向相关责任方寻求解决, 神牛对此不承担任何责任。因非在保修期或保修范围内的部件、附件或软件导致产品不能正常使用的, 不是保修范围内的故障。产品使用过程中正常的脱色, 磨损和消耗, 不是保修范围内的故障。

产品保修和服务支持信息

产品的保修期和服务类型按以下《产品保修信息》执行：

产品类别	选件名称	保修期 (月)	保修服务类型
部件	电路板	12	客户送修
	电池	3	客户送修
	充电器等带电性能的部件	12	客户送修
其他	如电池盒、防风棉、防风毛罩、锁紧装置、手提绳、扎带、魔术贴、	无	无保修

神牛产品售后服务电话：0755-29609320-8062

Warranty

Dear customers, as this warranty card is an important certificate to apply for our maintenance service, please fill in the following form in coordination with the seller and safe-keep it. Thank you!

Product Information	Model	Product Code Number
Customer Information	Name	Contact Number
	Address	
Seller Information	Name	
	Contact Number	
	Address	
	Date of Sale	
Note:		

Note: This form shall be sealed by the seller.

Applicable Products

The document applies to the products listed on the Product Maintenance Information (see below for further information). Other products or accessories (e.g. promotional items, giveaways and additional accessories attached, etc.) are not included in this warranty scope.

Warranty Period

The warranty period of products and accessories is implemented according to the relevant Product Maintenance Information. The warranty period is calculated from the day(purchase date) when the product is bought for the first time, And the purchase date is considered as the date registered on the warranty card when buying the product.

How to Get the Maintenance Service

If maintenance service is needed, you can directly contact the product distributor or authorized service institutions. You can also contact the Godox after-sale service call and we will offer you service. When applying for maintenance service, you should provide valid warranty

card. If you cannot provide valid warranty card, we may offer you maintenance service once confirmed that the product or accessory is involved in the maintenance scope, but that shall not be considered as our obligation.

Inapplicable Cases

The guarantee and service offered by this document are not applicable in the following cases: ①. The product or accessory has expired its warranty period; ②. Breakage or damage caused by inappropriate usage, maintenance or preservation, such as improper packing, improper usage, improper plugging in/out external equipment, falling off or squeezing by external force, contacting or exposing to the improper temperature, solvent, acid, base, flooding and damp environments, etc; ③. Breakage or damage caused by non-authorized institution or staff in the process of installation, maintenance, alternation, addition and detachment; ④. The original identifying information of product or accessory is modified, alternated, or removed; ⑤. No valid warranty card; ⑥. Breakage or damage caused by using illegally authorized, nonstandard or non-public released software; ⑦. Breakage or damage caused by force majeure or accident; ⑧. Breakage or damage that could not be attributed to the product itself. Once met these situations above, you should seek

solutions from the related responsible parties and Godox assumes no responsibility. The damage caused by parts, accessories and software that beyond the warranty period or scope is not included in our maintenance scope. The normal discoloration, abrasion and consumption are not the breakage within the maintenance scope

Maintenance and Service Support Information

The warranty period and service types of products are implemented according to the following

Product Maintenance Information:

Product Type	Name	Maintenance Period (month)	Warranty Service Type
Parts	Circuit Board	12	Customer sends the product to designated site
	Battery	3	
	Charger, Electrical Parts etc.	12	
Other Items	Battery Case, Windscreen Foam, Wind Cap, Locking Device, Lanyard, Tie,	NO	Without warranty

Godox After-sale Service Call: **0755-29609320-8062**