

合格证
QC PASS

Godox

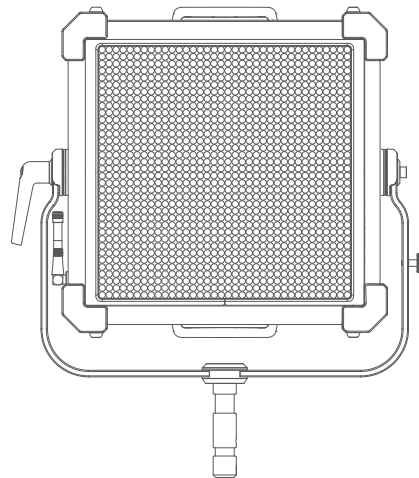

Wechat
Official Account
神牛微信公众号

深圳市神牛摄影器材有限公司

地址: 深圳市宝安区福海街道塘尾社区福川工业区厂房2栋 电话: 0755-29609320(8062)

传真: 0755-25723423 邮箱: godox@godox.com

GODOX Photo Equipment Co.,Ltd.

Add.: Building 2, Yaochuan Industrial Zone, Tangwei Community, Fuhai Street, Bao'an District,

Shenzhen 518103, China Tel: +86-755-29609320(8062) Fax: +86-755-25723423

E-mail: godox@godox.com

godox.com

Made in China | 705-P600BH-04



KNOWLED P600Bi Hard

诺力LED影视面板灯
KNOWLED LED Light Panel

使用手册
Instruction Manual

重要的安全说明及注意事项

首先作为最基本原则：本产品为专业灯光布景设备，应由专业灯光师使用或在专业人士指导下使用。使用时必须始终遵循基本的安全预防措施，具体安全预防措施如下：

1. 使用前必须阅读并理解产品说明书。
2. 专业灯具，禁止儿童使用。当儿童靠近时，家长或监护人必须密切监督，以免儿童因碰撞灯具或私用灯具造成人身伤害。
3. 本灯具并非普通照明灯具，不可用于普通照明，任何有过眼部损伤或眼部敏感的人群均应避免使用本灯具。
4. 灯具点亮时，必须小心使用，禁止接触高温部件，如LED灯珠，以免造成灼伤。
5. 灯具点亮时，任何情况下均禁止直视灯珠。应该在专业灯光师指导下使用强光，任何情况下避免长时间处于强光环境，如引起眼睛不适，请及时关闭灯具，暂停使用，请及时就医。
6. 倘灯珠损坏或因热变形，应停止使用，并及时联系制造商、服务代理商或合格的维修人员更换灯珠，以免发生意外。
7. 本产品仅适用于-20~45℃工作环境温度及正常湿度环境下使用。
8. 请勿使用损坏的设备或设备配件，待专业维修人员检查维修，确认设备正常方可使用。
9. 在使用过程中，如果本产品由于跌落、受到挤压或遭受强烈冲击而造成外壳破裂的，请勿继续使用，以免因接触到内部电子元件而受到电击伤害。
10. 如需要延长线，请使用额定电流≥该设备额定电流的延长线。如延长线额定电流小于该设备，可能导致过热。
11. 部分产品电源线较长，请合理放置电源线，使其处于安全位置。避免电源线接触过热物体表面、避免放置不当导致拉扯损坏或绊倒现场人员。请使用本厂原装电源线，如使用非本厂电源线导致产品损坏，概不在本厂维修范围内。
12. 在清洁和维修之前，请务必从电源插座上拔下该设备插头。不使用时，禁止拉扯电源线以将设备插头从电源插座中拔出。正常断电，应是用手抓住该设备插头两端，将插头从电源插座中拔出。此设备需连接到接地插座中。
13. 本设备没有防水性能，请让设备保持干燥，请勿将本设备浸入水中或其他液体中。设备需安装在干燥且通风处，避免在雨天、潮湿、多尘或过热环境下使用。请勿将任何物体置于灯具上或使液体流入灯具内部，以免发生意外。
14. 请勿私自拆卸产品，如产品出现故障，须由本公司或授权的维修人员进行检查维修。
15. 存放本设备之前，请确保设备已完全冷却。存放时，将电源线从设备上拔出。设备应放置于设备便携包内或通风干燥处。
16. 请勿将设备放置在酒精、汽油等易燃易爆挥发的溶剂附近。
17. 本厂不推荐的产品附件，请勿使用，以免导致火灾、触电或人身伤害。
18. 清洁本设备时，请勿用湿布擦拭，请用干布、软布擦拭设备污垢。
19. 设备使用前，请注意将保护罩取下。
20. 本产品已通过ROHS, CE和FCC认证，请参考相关国家标准使用和操作。
21. 安全说明依据本厂严格测试制定，设备设计和规格如有变更，恕不另行通知。客户可以上神牛官网查看最新的电子版说明，了解产品最新资讯。
22. 部分产品内置锂电池。此类产品请使用专用的充电器进行充电，并且按正确的操作说明，在规定的电压、温度范围内使用。
23. 部分产品使用电池供电。此类产品请勿使用说明书中未指定的任何电池、电源或附件。请将电池和其他附件置于儿童及婴幼儿无法触及之处。如果儿童或婴幼儿吞下电池或附件，请立刻就医。

如果电池漏液、变色、变形、冒烟或发出异味，请立刻将其取出。在取出过程中请小心，以免受伤。如果继续使用，可能会引起火灾、触电或皮肤烫伤。请勿使用任何变形或改造过的电池。请勿拆卸或改造本产品或电池。请勿加热电池或焊接电池。请勿让电池与火或水接触。请勿让电池受到强烈的外力撞击。请勿将电池的正负端错误插入，或将新旧电池或不同类型的电池混合使用。

24. 一年保修期，消耗品电池、适配器、电源线等配件不在此保修范围内。
25. 经发现，擅自检修设备，将取消一年保修期，维修需要收取相关费用。
26. 对于不规范操作引起的机器故障不在保修范围内。

保存这些说明

前言

感谢您购买神牛产品。

神牛全新推出大功率双色温LED影视面板灯P600Bi Hard，输入高达700W，支持AC 100V-240V供电，可在全球范围内使用；拥有超高亮度、千分级亮度调节、4种调光曲线、2800K-6500K色温、平均CRI≥96、平均TLCI≥96、多种无线控制等诸多特性；适用于大型摄影棚、影视基地、演播室、户外外景、大型实地场等拍摄场景。

主要特点

- 600W超强输出功率，全色温段足功率输出
- 真正千分级调节，能从100%完美平滑调光至0%
- 4种调光曲线：线性、S曲线、指数、对数
- 宽广色温，调节范围：2800K-6500K
- 多种智能控制方式，DMX 512控台控制/LumenRadio CRMX控制/蓝牙APP控制/2.4GHz无线控制。
- 高效散热风扇，配合全新散热设计，满足大功率灯具散热需求
- 11类FX光效模式：闪光灯、雷闪电、多云、坏灯泡、电视机、蜡烛、火、烟花、爆炸、焊接、SOS

警告

- ▲ 大功率LED灯，严禁直视灯源或照射他人眼睛。
- ▲ 严禁通电时插拔电源线，以免造成人身伤害。
- ▲ 本灯具工作时，请勿遮挡散热口。
- ▲ 请勿让儿童靠近、接触或使用本灯具。
- ▲ 专业灯光设备，请务必按照使用手册正确操作。



请勿直视光源

部件名称

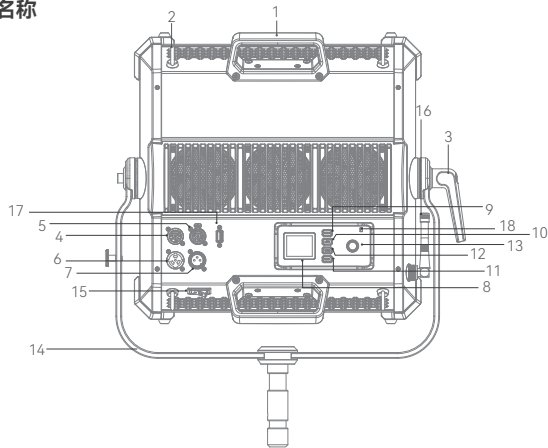

- | | | |
|-----------------|-----------------|--------------|
| 1. 提手 | 7. DC INPUT输入接口 | 13. 调节旋钮 |
| 2. 吊环 | 8. 显示屏 | 14. U型支架 |
| 3. 调节方向把手 | 9. PRESET按键 | 15. 电源开关按钮 |
| 4. DMX IN输入接口 | 10. LOCK按键 | 16. CRMX天线 |
| 5. DMX OUT输出接口 | 11. MENU按键 | 17. USB-A 接口 |
| 6. AC INPUT输入接口 | 12. MODE按键 | 18. CRMX指示灯 |

U架安装指南

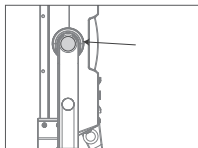

1. 先装一侧：灯具竖着摆放，将塑料垫块垫在灯具安装孔与U型支架安装孔中间。

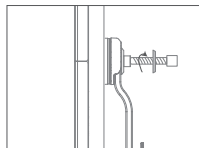

2. 螺丝柱放入金属垫块，插入U型支架安装孔，顺时针旋转拧紧即可。

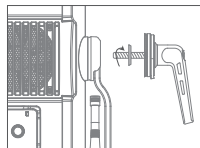

3. 另外一侧：按照上述步骤安装即可。

连接DMX控制台

无线DMX连接

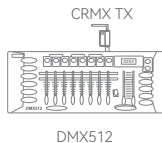

DMX512



CRMX



CRMX



CRMX

有线DMX连接

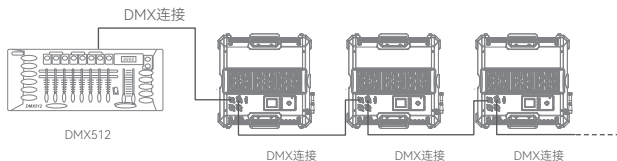

DMX512

DMX连接

DMX连接

DMX连接

注：DMX连接线需另购

物品清单

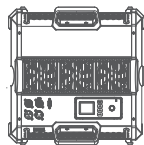

灯体*1

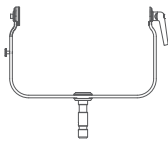

U型支架*1



天线*1



绑绳*1



安全绳*1



交流电源线*1



六角扳手*1

温馨提示：说明书线图均为示意图，仅供参考。由于产品不断更新与升级，产品实物与线图可能存在差异，请以实物为准。

可另购附件



太空灯柔光罩P600BHSS

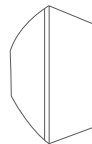

方形柔光箱P600BHS22



偏移支架HJ02



多头支架HJ04

开关机

接通电源，拨动电源开关按键，实现开机(ON)或关机(OFF)。

色温模式

短按MODE按键切换至色温模式。短按调节旋钮可切换亮度设置/色温设置。

1. 切换至亮度设置，旋转调节旋钮调节亮度百分比，顺时针旋转一次增加0.1个单元值，逆时针旋转一次减少0.1个单元值；快速旋转，进入快调模式，调节范围为0%-100%。
2. 切换至色温设置，旋转调节旋钮调节色温值，顺时针旋转一次增加100个单元值，逆时针旋转一次减少100个单元值；快速旋转，进入快调模式，调节范围为2800K-6500K。

99.3%

3200K

FX光效模式

短按MODE按键切换至FX光效模式。旋转调节旋钮依次选择闪光灯/雷闪电/多云/坏灯泡/电视机/蜡烛/火/烟花/爆炸/焊接/SOS场景等11类光效。

选中所需光效，短按调节旋钮进入光效设置界面。光效设置完毕，短按MODE按键返回上一级。

1. 闪光灯光效

进入闪光灯光效，旋转调节旋钮选择亮度百分比、开关、色温、触发、速度、模式等选项。短按调节旋钮选中选项，旋转调节旋钮可调节选项（自动、手动等选项除外）。

注：选中手动，通过短按一次调节旋钮触发一次闪光灯光效。



2. 雷闪电光效

进入雷闪电光效，旋转调节旋钮选择亮度百分比、开关、色温、触发、闪光次数、频率等选项。短按调节旋钮选中选项后，旋转调节旋钮可调节选项参数（自动、手动等选项除外）。

注：选中手动，通过短按一次调节旋钮触发一次雷闪电光效。

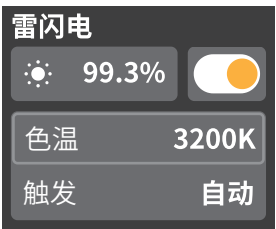

亮度调节范围：0%-100%
色温：2800K-6500K
闪光次数：随机/1-10
频率：随机/1-20

3. 多云光效

进入多云光效，旋转调节旋钮选择亮度百分比、开关、亮暗比例、速度等选项。短按调节旋钮选中选项后，旋转调节旋钮可调节选项参数。

亮度调节范围：0%-100%
亮暗比例：30-90
速度：随机/1-100

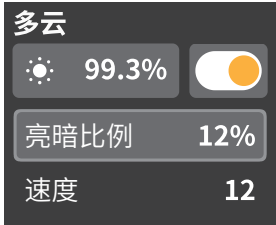

4. 坏灯泡光效

进入坏灯泡光效，旋转调节旋钮选择亮度百分比、开关、色温、速度等选项。短按调节旋钮选中选项后，旋转调节旋钮可调节选项参数。

亮度调节范围：0%-100%
色温：2800K-6500K
速度：1-100

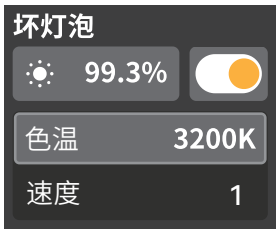

5. 电视机光效

进入电视机光效，旋转调节旋钮选择亮度百分比、开关、速度等选项。短按调节旋钮选中选项后，旋转调节旋钮可调节选项参数。

亮度调节范围：0%-100%
速度：随机/1-100



6. 蜡烛光效

进入蜡烛光效，旋转调节旋钮选择亮度百分比、开关、速度等选项。短按调节旋钮选中选项后，旋转调节旋钮可调节选项参数。

亮度调节范围：0%-100%
速度：随机/1-100



7. 火光效

进入火光效，旋转调节旋钮选择亮度百分比、开关、速度等选项。短按调节旋钮选中选项后，旋转调节旋钮可调节选项参数。

亮度调节范围: 0%-100%

速度: 随机/1-100

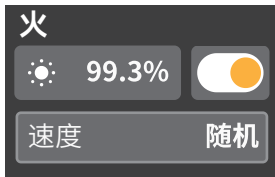

8. 烟花光效

进入烟花光效，旋转调节旋钮选择亮度百分比、开关、速度、余烬等选项。短按调节旋钮选中选项后，旋转调节旋钮可调节选项参数。

亮度调节范围: 0%-100%

速度: 随机/1-100

余烬: 1-100

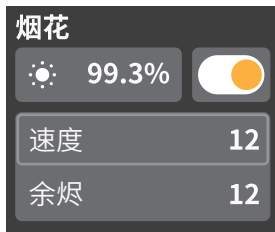

9. 爆炸光效

进入爆炸光效，旋转调节旋钮选择亮度百分比、开关、触发、色温、速度、余烬等选项。短按调节旋钮选中选项后，旋转调节旋钮可调节选项参数(自动、手动等选项除外)。

注: 选中手动，通过短按一次调节旋钮触发一次爆炸光效。

亮度调节范围: 0%-100%

色温: 2800K-6500K

速度: 1-100

余烬: 1-100



10. 焊接光效

进入焊接光效，旋转调节旋钮选择亮度百分比、开关、速度、色温等选项。短按调节旋钮选中选项后，旋转调节旋钮可调节选项参数。

亮度调节范围: 0%-100%

色温: 2800K-6500K

速度: 随机/1-100

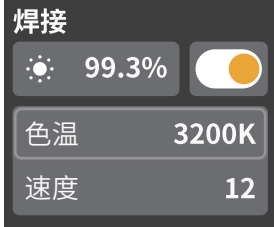

11. SOS光效

进入SOS光效，旋转调节旋钮选择亮度百分比、开关、色温等选项。短按调节旋钮选中选项后，旋转调节旋钮可调节选项参数。

亮度调节范围: 0%-100%

色温: 2800K-6500K

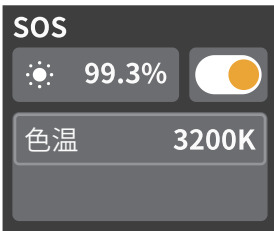

注: 使用FX场景光效时，调光曲线默认为线性

菜单设置

短按MENU按键进入菜单设置，旋转调节旋钮选择DMX、CRMX、蓝牙、无线、调光曲线、风扇、屏幕设置、语言、系统升级、恢复出厂、关于本机。

1. DMX

短按调节旋钮进入DMX设置界面。旋转调节旋钮选择地址/DMX模式/RDM状态/DMX丢失状态/终止开关/DMX增强通道。短按调节旋钮进入选项设置，通过旋转调节旋钮完成选项设置。选项设置完毕，短按MENU按键返回上一级。



连接有线DMX, 灯体界面



连接CRMX, 灯体界面



一级选项	二级选项	说明
地址	001-512	起始地址
DMX模式	01.CCT 8 bit	8位CCT模式
	02.FX 8 bit	8位FX模式
	03.CCT 16 bit	16位CCT模式
	04.FX 16 bit	16位FX模式
	05.ULTIMATE DMX 8 bit	8位 ULTIMATE DMX模式
	06.ULTIMATE DMX 16 bit	16位 ULTIMATE DMX模式
RDM状态	开启	开启RDM, 开启后控制台可设置灯具地址及DMX模式
	关闭	关闭RDM
DMX丢失状态	保持最后状态	失去DMX控制信号后, 在关机或再次接收有效DMX控制信号前, 持续使用最后一次接收的DMX控制信号
	直接关闭	灯具直接熄灭
	保持最后状态2分钟熄灭	失去DMX控制信号后, 持续使用最后一次接收的DMX控制信号2分钟, 2分钟后灯具熄灭。注: 如2分钟内接收到有效DMX控制信号, 则使用新的DMX控制信号。
终止开关	开启	开启DMX终端
	关闭	关闭DMX终端
DMX增强通通	开启	开启增强通通信号
	关闭	关闭增强通通信号

2.CRMX

短按调节旋钮进入CRMX设置界面。旋转调节旋钮选择CRMX开关/CRMX重置。通过短按调节旋钮进入某项设置。

CRMX开关: 通过旋转调节旋钮完成设置。
CRMX重置: 通过短按调节旋钮完成设置。
设置完毕, 短按MENU按键返回上一级。



3. 蓝牙

短按调节旋钮进入蓝牙设置界面。旋转调节旋钮选择蓝牙开关/蓝牙重置。通过短按调节旋钮进入某项设置。

蓝牙开关: 通过旋转调节旋钮完成设置。
蓝牙重置: 通过短按调节旋钮完成设置。
设置完毕, 短按MENU按键返回上一级。

蓝牙MAC码: 位于界面右下角, 方便查找灯具蓝牙。

扫描下方二维码即可下载“Godox Light”手机APP (安卓和苹果系统都可以使用)。

注:

1. 首个移动设备 (手机或平板电脑) 可直接使用APP操控灯体。更换其他移动设备时, 灯体需进行蓝牙重置方可正常使用APP。
2. APP需升级至V3.0以上版本。

4. 无线

短按调节旋钮进入无线设置界面。旋转调节旋钮选择无线/组别/通道/识别号。短按调节旋钮进入选项设置, 通过旋转调节旋钮完成选项设置。选项设置完毕, 短按MENU按键返回上一级。

无线: 开启2.4G无线接收/关闭2.4G无线接收

组别: 0-9/A-F

通道: 01-32

识别号: OFF/01-99

注: 使用遥控器RC-A611 (另购) 或遥控器RC-R911 (另购) 时, 遥控器组别、通道和ID号需和灯体组别、通道和识别号 (ID号) 相同。

5. 调光曲线

短按调节旋钮进入调光曲线设置界面。旋转调节旋钮选择线性、S曲线、指数、对数。设置完毕, 短按调节旋钮/MENU按键返回上一级。



6. 风扇

短按调节旋钮进入风扇设置。旋转调节旋钮选择静音、自动、中速、高速。选择完毕，短按调节旋钮/MENU按键返回上一级。

不同状态下灯体最大亮度值 (%)

风扇状态	线性	S曲线	指数	对数
静音 (关闭)	20%	36.5%	52.4%	8.7%
自动	100%	100%	100%	100%
中速	75%-100%	60%-100%	86%-100%	40%-100%
高速	100%	100%	100%	100%

注：风扇处于中速模式时，最大亮度值随着环境温度变化而变化。

7. 屏幕设置

短按调节旋钮进入屏幕设置。短按调节旋钮选中设置，旋转调节旋钮调节参数，调节范围为10-100。设置完毕，短按MENU按键返回上一级。

8. 语言

短按调节旋钮进入语言设置。旋转调节旋钮选择中文/English，短按调节旋钮完成设置。设置完毕，短按MENU按键返回上一级。

9. 系统升级

短按调节旋钮进入系统升级，在此界面可查看灯具固件版本及升级固件提示。查看完毕，短按MENU按键返回上一级。

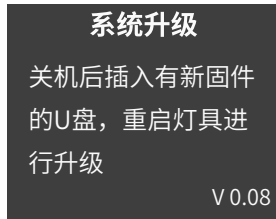
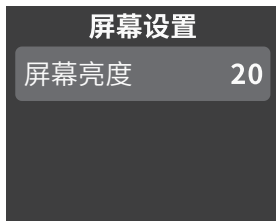

升级详情

1. 在官网 (<https://www.godox.com.cn/firmware-continuous-light>) 下载新固件到U盘上。
2. 在关机的状态下，将存有新固件的U盘插入Type-A USB端口。
3. 开机，灯具P600Bi Hard自动进入升级界面。
4. 升级完毕自动跳回主界面。

注：

1. 必须在官网下载新固件，存放在U盘根目录里，而且仅有一个BIN文件。
- 2.Type-A USB端口支持供电，输出电压电流5V/2A，请勿接入大功率USB设备

10. 恢复出厂

短按调节旋钮进入恢复出厂设置。旋转调节旋钮选择确定/取消，短按调节旋钮选择相关选项。选择恢复出厂后，界面自动跳转到语言设置。



11. 关于本机

短按调节旋钮进入关于本机，在此界面可查看型号、UID号、固件版本、灯头温度、认证信息等信息。查看完毕，短按MENU按键返回上一级。



锁定设置

短按LOCK按键，屏幕出现  表示当前界面被锁定；再次短按LOCK按键便可解锁。

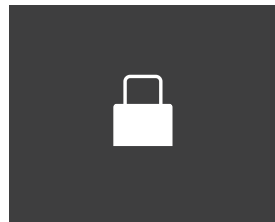

预存设置

短按PRESET按键进入预存灯具光效界面。旋转调节旋钮选择1-20组预设，短按调节旋钮进入预设组设置，通过旋转调节旋钮可选应用/保存/取消，最后短按调节旋钮完成设置。设置完毕，短按PRESET按键退出预存设置。

注：如某组未预存过光效，选项中没有应用选项。



功率限制模式

按住调节旋钮的同时，拨动开关按键开机或按住调节旋钮的同时，插入48V直流电源供电，灯具进入功率限制模式，此时灯具限制最大功率可选20%、40%、60%、80%、100%。

注：每次重新开机会自动解除功率限制，最大功率恢复为100%。

维护保养

一年保修期，消耗品电池，适配器，电源线等配件不在此保修范围内。

经发现，擅自检修此LED影视灯，将取消LED影视灯一年保修期，维修需要收取相关费用。

对于不规范操作引起的机器故障不在保修范围内。

所有维修一概由本厂指定的可供原配件的维修部负责。

如本品出现故障或者被水淋湿，在专业人员维修后方可继续使用。LED影视灯在工作时，如发现异常，应立即关掉电源，查明原因。

照度数据

色温	测试状态	照度单位	1m	3m	5m	7m	9m
2800K	裸灯	lux	80700	9810	3680	2010	1290
		fc	7500	911	342	187	120
lux		84900	10300	3900	2110	1360	
fc		7890	960	362	196	127	
4300K		lux	88900	10700	4060	2200	1420
		fc	8260	997	377	204	132
5600K		lux	93800	11400	4300	2330	1500
		fc	8720	1060	400	216	139
6500K		lux	94200	11600	4370	2380	1530
		fc	8750	1080	406	221	142

数据均为平均值，非绝对值，以上测试皆在灯体100%亮度下进行。

规格参数

型号	P600Bi Hard
供电	100V-240V-50/60Hz 7A
最大功率	700W
色温	2800K-6500K
调光范围	0%-100%
调光模式	线性/S曲线/指数/对数
光效模式	11类
CRI	≥96
TLCI	≥96
控制方式	DMX 512控制台控制，支持RDM协议/LumenRadio/CRMX控制/2.4G无线控制/蓝牙APP控制/灯体控制
蓝牙控制距离	最远30m
2.4G控制距离	最远100m
Type-A USB接口	固件升级/5V=2A供电
尺寸(包含U型支架)	571mm*499mm*121mm
净重=	10kg

设计和规格如有变更，恕不另行通知。

本设备包含型号核准代码为：CMIIT ID:2023DP7590，为该产品的无线电发射模块。

Important Safety Instructions and Precautions

First of all, as the most basic principle: This product is a professional lighting set equipment and should be used by professional lighting engineers or under the guidance of professionals. Basic safety precautions must always be followed during use, as follows:

1. The product manual must be read and understood before use.
2. Professional lighting is prohibited for children. When children are near, parents or accompanying persons must supervise closely to prevent children from personal injury due to collision with lamps or private use of lamps.
3. This lighting product is not ordinary lighting product and cannot be used for general lighting. Anyone who has suffered eye damage or has sensitive eyes should avoid using this product.
4. When the lamp is on, it must be used with care. Do not touch high-temperature parts, such as LED lamp beads, to avoid burns.
5. When the lamp is on, it is forbidden to look directly at the lamp beads under any circumstances. Strong light should be used under the guidance of professional lighting engineers. Avoid prolonged exposure to strong light under any circumstances. If eye discomfort, please turn off the lamp in time, suspend use, and seek medical attention in time.
6. If the lamp bead is damaged or deformed by heat, stop using it, and contact the manufacturer, service agent or qualified maintenance personnel to replace the lamp bead in time to avoid accidents.
7. This product is only suitable for use in -20°C-45°C working environment temperature and normal humidity environment.
8. Do not use damaged equipment or accessories, and wait for professional maintenance personnel to check and repair to confirm being normal before use.
9. During using, if the casing of this product is broken due to being dropped, squeezed or subjected to strong impact, please do not use it, so as to avoid electric shock injury due to contact with internal electronic components.
10. If an extension cord is required, please use an extension cord with a current rating greater than or equal to that of the equipment. If an extension cord is rated less than the equipment, overheating may result.
11. Some products have long power cords, please place the power cords properly and keep them in a safe place. Avoid contacting the power cord with hot surfaces, avoid misplacement that could cause pulling damage, or trip on-site personnel. Please use the certified power cord from the original manufacturer. If the product is damaged by using a non-certified power cord, it will not be repaired by our factory.
12. Be sure to unplug equipment from the power outlet before cleaning and repairing. When not in use, do not pull the power cord to unplug the equipment. For normal power-off, please hold both ends of the plug of the equipment with your hands and pull the plug out of power outlet. This equipment needs to be connected to a grounded outlet.
13. This equipment is not waterproof, please keep it dry and do not immerse it in water or other liquids. The equipment should be installed in a dry and ventilated place, and avoid using it in rainy, humid, dusty or overheated environments. Do not place any objects on the lamp or let liquid flow into the lamp to avoid accidents.
14. Do not disassemble the product without permission. If the product fails, it must be checked and repaired by authorized maintenance personnel.
15. Before storing, make sure that the equipment has cooled down completely. For storage, unplug the power cord from the equipment. The equipment should be placed in the carrying case or in a ventilated dry place.
16. Do not place equipment near flammable and volatile solvents such as alcohol and gasoline.
17. Do not use accessories that are not recommended by our factory to avoid fire, electric shock or personal injury.
18. When cleaning, do not wipe it with a damp cloth, please use a dry cloth or a soft cloth to wipe the dirt of the equipment.
19. Please take off the protective cover before using.
20. This product has passed ROHS, CE, and FCC certification, please refer to the relevant national standards for use and operation.
21. The safety instructions are formulated according to the strict testing of the factory, and the design and specifications of the equipment are subject to change without prior notice. Customers can view the latest electronic instructions on the official website of GODOX and learn about the latest product information.
22. Some products have built-in lithium batteries. Please use a special charger to charge, and use them within the specified voltage and temperature range according to the correct operating instructions.
23. Some products are battery powered. Do not use any batteries, power sources or accessories not specified in the instructions for such products. Keep batteries and other accessories out of the reach of children and infants. In the instance that a child or infant swallows a battery or accessory, immediate emergency medical attention is required. If the battery leaks, becomes discolored, deformed, emits smoke, or emits an abnormal odor, remove it immediately. Be careful during removal to avoid burns. Continued use may result in fire, electric shock, or skin burns. Do not use any deformed or modified batteries. Do not disassemble or modify this product or battery. Do not heat or solder the battery. Keep the battery away from fire or water. Do not incorrectly insert the positive and negative ends of batteries, or mix old and new batteries or different types of batteries.
24. One-year warranty period, accessories such as consumable batteries, adapters, power cords, etc. are not covered by this warranty.
25. If it is found that the equipment is repaired without authorization, the one-year warranty period will be cancelled and relevant fees will be charged for maintenance.
26. Machine failures caused by non-standard operation are not covered by the warranty.

keep these instructions!

Forword

P600Bi Hard is the brand new bi-color LED light panel with powerful features and functions such as input power 700W, 100V-240V AC power supply, ultra-high and thousand-bit adjustable brightness, four dimming curves, wide CCT range from 2800K to 6500K, average CRI \geq 96 & average TLCI \geq 96, various wireless controlling methods, and etc. It is suitable for shooting scenes in large film studios, broadcast studios, outdoor exteriors and large field scenes.

Main Features

- 600W strong output power in full CCT range.
- Thousand-bit adjustable brightness from 0% to 100% .
- Four dimming curves: linear, S-curve, exponential, logarithmic.
- Wide CCT range adjustable from 2800K to 6500K.
- Various controlling methods: support DMX 512/LumenRadio CRMX/Bluetooth APP/2.4GHz wireless control.
- Efficient heat dissipation system with fans to meet the cooling needs of large LED light.
- 11 FX modes: flash, lightning, cloudy, broken bulb, TV, candle, fire, firework, explosion, welding, SOS.

Warning

- ▲ Do not look directly at the LED light or illuminate at others' eyes.
- ▲ Do not plug or unplug the power cable or connecting cable when the power is turned on, otherwise personal injuries may occur.
- ▲ Do not cover the heat dissipation vent in working status.
- ▲ Keep out of reach of children.
- ▲ Please make sure to follow the instruction manual and correctly use this professional lighting device.



Do not stare at the operating light source

Name of Parts

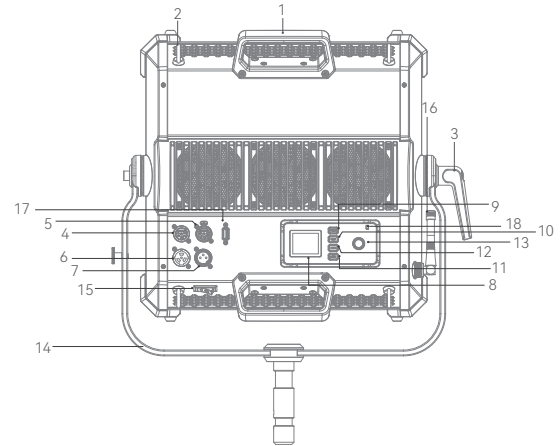

- | | | |
|----------------------------|------------------|-------------------------|
| 1. Handle | 7. DC INPUT Port | 13. Adjust Dial |
| 2. Ring | 8. Display | 14. U-type Bracket |
| 3. Direction Adjust Handle | 9. PRESET Button | 15. Power Switch Button |
| 4. DMX IN Port | 10. LOCK Button | 16. CRMX Antenna |
| 5. DMX OUT Port | 11. MENU Button | 17. USB-A Port |
| 6. AC INPUT Port | 12. MODE Button | 18. CRMX Indicator |

U-type Bracket Installation

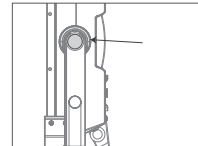

1. Place the light upright, put the plastic pad between the light mounting hole on one side and the U-type bracket mounting hole.

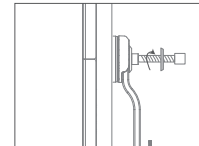

2. Insert the metal pad and screw into U-type bracket mounting hole, then rotate clockwise to tighten it.

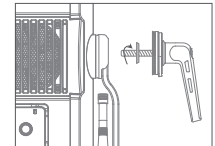

3. Install the other side as well according to step 1 and 2.

Wireless DMX Controller

Wireless DMX Connection

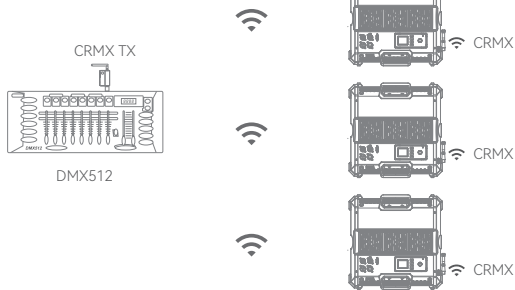

DMX512

Wired DMX Connection

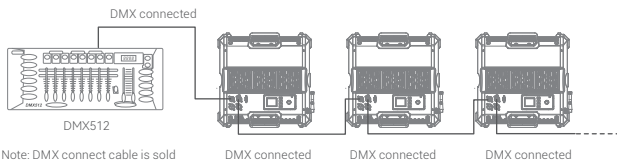

Note: DMX connect cable is sold separately.

DMX connected

DMX connected

DMX connected

What's Inside

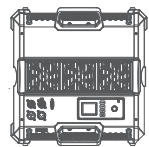

Light Body*1

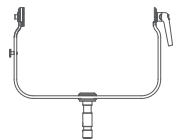

U-type Bracket *1



Antenna *1



Tying Rope *1



Safety Rope*1



AC Power Cable *1



Hex Wrench *1

Note: Due to continuous updates and upgrades of the products, there may be differences between the actual products and the pictures. Therefore, the pictures are for reference only, products to prevail in kind.

Separately Sold Accessories



Space light softbox P600BHSS

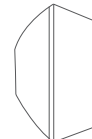

Rectangular Softbox P600BHS22



Junior Offset Arm HJ02

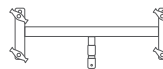

Junior Multi-Header HJ04

Power Switch

Toggle the power switch button after connecting to power source to turn on or off the device.

CCT Mode

Short press the MODE button to switch to CCT mode. Short press the adjust dial to switch between the brightness setting interface and color temperature setting interface.

1. In the brightness setting interface, turn the adjust dial to adjust the brightness ratio from 0% to 100%. Rotate the adjust dial clockwise once can increase the value by 0.1 unit, while rotate counterclockwise once can decrease the value by 0.1 unit. Quick adjustment is also available when rotating quickly.
2. In the color temperature setting interface, turn the adjust dial to adjust the color temperature from 2800K to 6500K. Rotate the adjust dial clockwise once can increase the value by 100 units, while rotate counterclockwise once can decrease the value by 100 units. Quick adjustment is also available when rotating quickly.

99.3%

3200K

FX Mode

Short press the MODE button to switch to FX mode. Turn the adjust dial to switch among the following effects: flash, lightning, cloudy, broken bulb, TV, candle, fire, firework, explosion, welding, SOS.

Select the desired effect and short press the adjust dial to enter the effect setting interface, then short press the MODE button to return to the previous menu.

1. Flash Effect

In the flash effect setting interface, rotate the adjust dial to select options among dim, switch, CCT, trigger, speed, mode, etc. Short press the adjust dial to select the desired option then rotate to adjust settings (except for the auto and manual options).

Note: Select manual, then the flash effect can be triggered once by short press the adjust dial once.

Dim: 0%-100%
CCT: 2800K-6500K
Times: Random/1-10
Frequency: Random/1-20

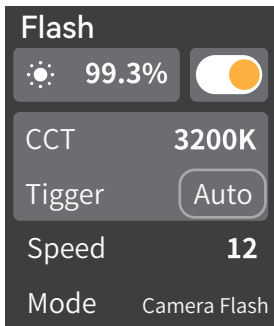

2. Lightning Effect

In the lightning effect setting interface, rotate the adjust dial to select options among dim, switch, CCT, trigger, times, frequency, etc. Short press the adjust dial to select the desired option then rotate to adjust settings (except for the auto and manual options).

Note: Select manual, then the lightning effect can be triggered once by short press the adjust dial once.

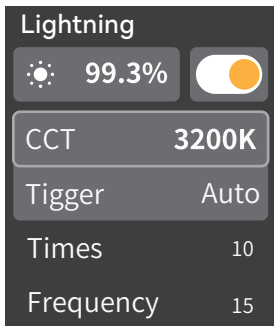

3. Cloudy Effect

In the cloudy effect setting interface, rotate the adjust dial to select options among dim, switch, ratio, speed, etc. Short press the adjust dial to select the desired option then rotate to adjust settings.

Dim: 0%-100%
Ratio: 30-90
Speed: Random/1-100

4. Broken Bulb Effect

In the cloudy effect setting interface, rotate the adjust dial to select options among dim, switch, ratio, speed, etc. Short press the adjust dial to select the desired option then rotate to adjust settings.

Dim: 0%-100%
CCT: 2800K-6500K
Speed: 1-100

5. TV Effect

In the TV effect setting interface, rotate the adjust dial to select options among dim, switch, speed, etc. Short press the adjust dial to select the desired option then rotate to adjust settings.

Dim: 0%-100%
Speed: Random/1-100

6. Candle Effect

In the candle effect setting interface, rotate the adjust dial to select options among dim, switch, speed, etc. Short press the adjust dial to select the desired option then rotate to adjust settings.

Dim: 0%-100%
Speed: Random/1-100

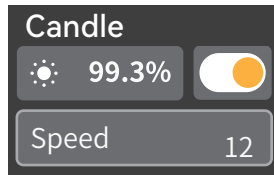
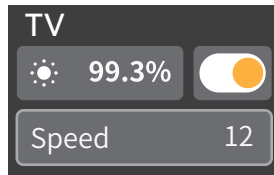
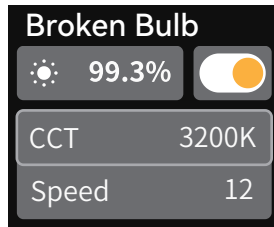
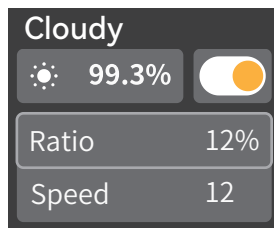

7. Fire Effect

In the fire effect setting interface, rotate the adjust dial to select options among dim, switch, speed, etc. Short press the adjust dial to select the desired option then rotate to adjust settings.

Dim: 0%-100%
Speed: 1-100

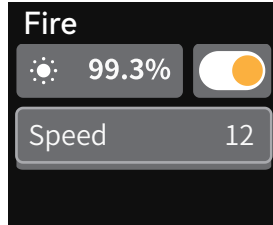

8. Firework Effect

In the firework effect setting interface, rotate the adjust dial to select options among dim, switch, speed, embers, etc. Short press the adjust dial to select the desired option then rotate to adjust settings.

Dim: 0%-100%
Speed: Random/1-100
Embers: 1-100

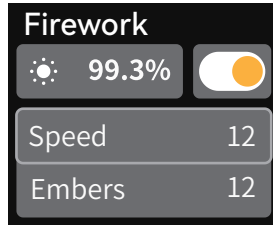

9. Explosion Effect

In the explosion effect setting interface, rotate the adjust dial to select options among dim, switch, CCT, trigger, speed, embers, etc. Short press the adjust dial to select the desired option then rotate to adjust settings (except for the auto and manual options).

Note: Select manual, then the explosion effect can be triggered once by short press the adjust dial once.

Dim: 0%-100%
CCT: 2800K-6500K
Speed: 1-100
Embers: 1-100

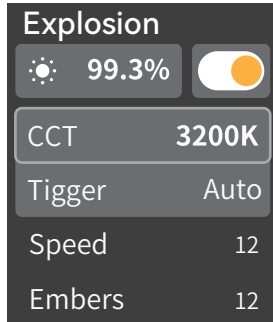

10. Welding Effect

In the welding effect setting interface, rotate the adjust dial to select options among dim, switch, CCT, speed, etc. Short press the adjust dial to select the desired option then rotate to adjust settings.

Dim: 0%-100%
CCT: 2800K-6500K
Speed: 1-100

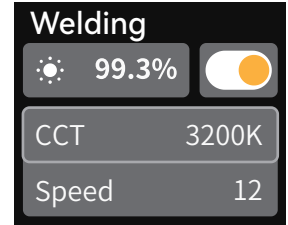

11. SOS Effect

In the SOS effect setting interface, rotate the adjust dial to select options among dim, switch, CCT, etc. Short press the adjust dial to select the desired option then rotate to adjust settings.

Dim: 0%-100%
CCT: 2800K-6500K



Note: The dimming curve is linear by default in FX mode.

Menu Settings

Short press the MENU button to enter menu settings, rotate the adjust dial to select among the following options: DMX, CRMX, Bluetooth, wireless, dimming curves, fan, display, language, version & upgrade, factory reset, fixture info.

1. DMX

Short press the adjust dial to enter DMX setting interface. Rotate the adjust dial to select options among address, DMX mode, RDM state, RDM lost, termination, Ext-Channels. Short press the adjust dial to select the desired option then rotate to adjust settings. Finally, short press the MENU button to return to the previous menu.

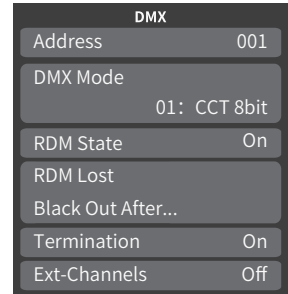

Interface when connected to wired DMX

DMX ☀️ 0%

DMX Mode: 01 CCT 8 Bit
 DMX Terminal: Off
 DMX Address: 1
 Occupied Channels: 2
 RDM State: On

Interface when connected to CRMX

CRMX ☀️ 0%

DMX Mode: 01 CCT 8 Bit
 DMX Terminal: Off
 DMX Address: 1
 Occupied Channels: 2
 RDM State: On

Level 1 Option	Level 2 Option	Description
Address	001:512	Initial address
DMX Mode	01:CCT 8 bit	CCT 8 bit
	02:FX 8 bit	FX 8 bit
	03:CCT 16 bit	CCT 16 bit
	04:FX 16 bit	FX 16 bit
	05:ULTIMATE DMX 8 bit	ULTIMATE DMX 8 bit
	06:ULTIMATE DMX 16 bit	ULTIMATE DMX 16 bit
RDM State	On	Turn on RDM, then the controller can set address and MDX mode.
	Off	Turn off RDM
DMX Lost	Hold Last Command	After the DMX control signal is lost, continue to use the last received DMX control signal until power down or a valid DMX control signal is received again.
	Black Out	The light is off immediately.
	Black Out After 2 Min	After the DMX control signal is lost, continue to use the last received DMX control signal for 2 minutes then black out. Note: If a valid DMX control signal is received within 2 minutes, then use the new DMX control signal.
Termination	On	Turn on DMX terminal
	Off	Turn off DMX terminal
	On	Turn on extend DMX channels
	Off	Turn off extend DMX channels

2. CRMX

Short press the adjust dial to enter CRMX setting interface. Rotate the adjust dial to select options between switch and reset. Short press the adjust dial to select the desired option then rotate or short press to adjust settings. Finally, short press the MENU button to return to the previous menu.

CRMX

CRMX On

Reset Reset

Status Unlink

3. Bluetooth

Short press the adjust dial to enter Bluetooth setting interface. Rotate the adjust dial to select options between switch and reset. Short press the adjust dial to select the desired option then rotate or short press to adjust settings. Finally, short press the MENU button to return to the previous menu.

Bluetooth MAC Code is on the left bottom of the display for searching the fixture by Bluetooth.

Scan the QR code to download the "Godox Light" smartphone APP (can be used in Android and Apple).

Note:

1. The APP can be used directly on the firstly installed device (smartphone or iPad). When change to other mobile device (smartphone or iPad), the light shall be reset before the normal connection of APP.
2. The APP should be upgraded to version 3.0 or above.

Bluetooth

Bluetooth On

Reset Reset

MAC:BA54



4. Wireless

Short press the adjust dial to enter wireless setting interface. Rotate the adjust dial to select options among switch, GR, CH, ID. Short press the adjust dial to select the desired option then rotate to adjust settings. Finally, short press the MENU button to return to the previous menu.

Wireless: Turn on/off 2.4G wireless

GR: 0-9/A-F

CH: 01-32

ID: 0FF/01-99

Note: When using the remote control RC-A6II (sold separately) or remote control RC-R9II (sold separately), the group, channel and ID of the remote control and light body should be the same.

Wireless

Wireless On

GR A

CH 1

ID 02

5. Dimming Curves

Short press the adjust dial to enter dimming curves setting interface. Rotate the adjust dial to choose among linear, s-curve, exponential and logarithmic. Finally, short press the adjust dial/MENU button to return to the previous menu.

Dimming Curves

Linear S-Curve

Exp Log

6. Fan

Short press the adjust dial to enter fan setting interface. Rotate and short press the adjust dial to choose among off, auto, medium, and high. Finally, short press the MENU button to return to the previous menu.

Max. Brightness Value (%) of the Light Body in Different Status

Fan Status	linear	S-curve	Exponential	logarithmic
Off	20%	36.5%	52.4%	8.7%
Auto	100%	100%	100%	100%
Medium	75%-100%	60%-100%	86%-100%	40%-100%
High	100%	100%	100%	100%

7. Display

Short press the adjust dial to enter display setting interface. Rotate and short press the adjust dial to adjust brightness from 10 to 100. Finally, short press the MENU button to return to the previous menu.

8. Language

Short press the adjust dial to enter language setting interface. Rotate and short press the adjust dial to select between Chinese and English. Finally, short press the MENU button to return to the previous menu.

9. Version & Upgrade

Short press the adjust dial to enter version & upgrade setting interface to check the firmware version and upgrade instruction. Then, short press the MENU button to return to the previous menu.

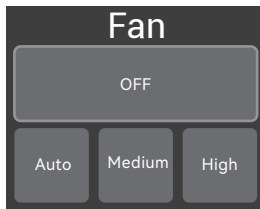

Note: When the fan is in medium mode, the maximum brightness value changes with the ambient temperature.



Firmware Upgrade

1. Download the new firmware to the U disk from official website (<https://www.godox.com/firmware-continuous-light>).
2. Turn off the device. Insert the U disk with new firmware into the Type-A USB port.
3. Turn on the device, and it will automatically enter the upgrading interface.
4. It will return to main interface after completion.

Notes:

1. New firmware must be downloaded from the official website, and keep only one BIN file in the root directory of the USB disk.
2. The Type-A USB port can only support output voltage and current of 5V/2A. Do not connect to over-rated USB device.

10. Factory Reset

Short press the adjust dial to enter factory reset setting interface. Rotate and short press the adjust dial to select apply or cancel. It will back to language setting interface after resetting.

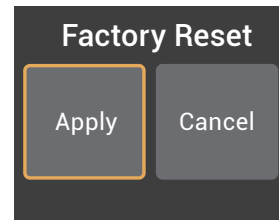

11. Fixture Info

Short press the adjust dial to enter fixture info setting interface to check model, UID, firmware version, light head temp., certification. Then, short press the MENU button to return to the previous menu.



Lock Setting

Short press the LOCK button, the panel is locked when is displayed on the panel, short press again to unlock.

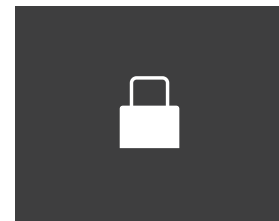

Presets Setting

Short press the PRESET button to enter preset effects interface. Rotate and short press the adjust dial to choose and enter preset effects 1-20, then short press to choose apply, save or cancel. Then, short press the adjust dial to return to the previous menu and short press the PRESET button to exit.

Note: There will be no option if a certain group has not been preset.

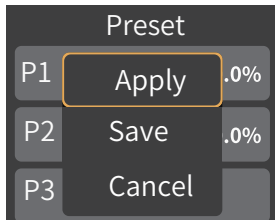

Limited Power Mode

Press and hold the adjust dial then toggle the power switch button, or press and hold the adjust dial then connect to 48V DC power source, the light will enter limited power mode, max power is selectable among 20%, 40%, 60%, 80% and 100%.

Note: The power limit will be automatically reset each time after rebooting, then the max power resume to 100%.

Maintenance

This product, except consumables, is supported with a one-year warranty.

Unauthorized service will void the warranty.

Maintenance of the light must be performed by our authorized maintenance department which can provide original accessories.

If the product had failures or was immersed into water, do not use it until it is repaired by professionals.

Shut down the device immediately should abnormal operation be detected.

Changes made to the specifications or designs may not be reflected in this manual.

Illuminance Data

CCT	Test Condition	Unit	1m	3m	5m	7m	9m
2800K	Bare Light	lux	80700	9810	3680	2010	1290
		fc	7500	911	342	187	120
lux		84900	10300	3900	2110	1360	
fc		7890	960	362	196	127	
4300K		lux	88900	10700	4060	2200	1420
		fc	8260	997	377	204	132
5600K		lux	93800	11400	4300	2330	1500
		fc	8720	1060	400	216	139
6500K		lux	94200	11600	4370	2380	1530
		fc	8750	1080	406	221	142

Note: The above values are average values instead of absolute values. All the above tests are based on the condition of 100% brightness.

Maintenance

Model	P600Bi Hard
Power Supply	100V-240V~50/60Hz 7A
Max. Power	700W
CCT	2800K-6500K
Brightness Range	0%-100%
Dimming Curves	linear, S-curve, exponential, logarithmic
FX Modes	11
CRI	≥96
TLCI	≥96
Controlling Methods	DMX 512 Control(support RDM protocol) /LumenRadio CRMX Control /2.4G Wireless Control/Bluetooth APP Control/Light Body Control
Bluetooth Controlling Distance	Max. 30m
2.4G Remote Controlling Distance	Max. 100m
Type-A USB Port	Firmware Upgrade/5V=2A Power Supply
Dimension (U-type Bracket is included in the light body)	571mm*499mm*121mm
Net Weight=	10kg

Specifications and data may subject to changes without notice.

FCC Statement

This device complies with part 15 of the FCC Rules. Operation is subject to the following two conditions:

- (1) This device may not cause harmful interference, and
- (2) this device must accept any interference received, including interference that may cause undesired operation.

Any Changes or modifications not expressly approved by the party responsible for compliance could void the user's authority to operate the equipment.

Note: This equipment has been tested and found to comply with the limits for a Class B digital device, pursuant to part 15 of the FCC Rules. These limits are designed to provide reasonable protection against harmful interference in a residential installation. This equipment generates uses and can radiate radio frequency energy and, if not installed and used in accordance with the instructions, may cause harmful interference to radio communications. However, there is no guarantee that interference will not occur in a particular installation. If this equipment does cause harmful interference to radio or television reception, which can be determined by turning the equipment off and on, the user is encouraged to try to correct the interference by one or more of the following measures:

- Reorient or relocate the receiving antenna.
- Increase the separation between the equipment and receiver.
- Connect the equipment into an outlet on a circuit different from that to which the receiver is connected.
- Consult the dealer or an experienced radio/TV technician for help.

The device has been evaluated to meet general RF exposure requirement.

The device can be used in portable exposure condition without restriction.

Warning

Operating frequency: 2412.999634MHz-2464.499756MHz(2.4G only receive)/2402MHz - 2480MHz (CRMX only receive)/2402MHz - 2480MHz (BT)

Maximum EIRP Power: 9.83dBm(BT)

Declaration of Conformity

GODOX Photo Equipment Co.,Ltd. hereby declares that this equipment are in compliance with the essential requirements and other relevant provisions of Directive 2014/53/EU. In accordance with Article 10(2) and Article 10(10), this product is allowed to be used in all EU member states. For more information of DoC, Please click this web link:

<https://www.godox.com/eu-declaration-of-conformity/>

The device complies with RF specifications when the device used at 0mm from your body.

产品保修

尊敬的用户, 本保修卡是申请保修服务的重要凭证, 请您配合销售商填写并妥善保管, 谢谢!

产品信息	型号	产品条码
用户信息	姓名	联系电话
	通信地址	
销售商信息	名称	
	联系电话	
	通信地址	
	销售日期	
备注		

注: 此表应由销售商盖章确认。

产品信息

本文件适用于相关《产品保修信息》(见后面说明)所列产品, 其他非属此范围的产品或部件(如促销品、赠品及其他出厂后附加的部件等)不在此保修承诺内。

保修期

产品及部件的相应保修期按相关的《产品保修信息》执行。保修期自产品首次购买日起算, 购买日以购买产品时保修卡登记日期为准。

如何获得保修服务

您可直接与产品销售商或授权服务机构联系, 也可拨打神牛产品售后服务电话, 与我们联系, 由我们的服务人员为您安排服务。申请保修时, 您应提供有效的保修卡作为保修凭证, 方可获得保修。如您不能提供有效的保修卡, 则在我们确认产品或部件属于保修范围的情况下, 也可以为您提供保修, 但这不作为我们的义务。

不适用保修的情况

如产品存在下列情况，本文件项下的保证和服务将不适用：①产品或部件超过相应保修期；②错误或不适当使用、维护或保管导致的故障或损坏，如：不当搬运；非按产品合理预期用途使用；不当插拔外接设备；跌落或外力挤压；接触或暴露于不适当温度、溶剂、酸碱、水浸或潮湿环境；③由非神牛授权机构或人员安装、修理、更改、添加或拆卸造成的故障或损坏；④产品或部件原有识别信息被修改变更或删除；⑤无有效保修卡；⑥使用非法授权、非标准或非公开发行的软件造成的故障或损坏；⑦因不可抗力或意外事件造成的故障或损坏；⑧其他非因产品本身质量问题导致的故障或损坏。遇上述情况，您应向相关责任方寻求解决，神牛对此不承担任何责任。因非在保修期或保修范围内的部件、附件或软件导致产品不能正常使用的，不是保修范围内的故障。产品使用过程中正常的脱色，磨损和消耗，不是保修范围内的故障。

产品保修和服务支持信息

产品的保修期和服务类型按以下《产品保修信息》执行：

产品类别	选件名称	保修期(月)	保修服务类型
部件	主机	12	客户送修
	电池	3	客户送修
	充电器等带电性能的部件。	12	客户送修
其他	如电源线、同步线闪光灯、造型灯泡、外壳、保护罩、锁紧装置、包装等。	无	无保修

神牛产品售后服务电话 0755-29609320-8062

Warranty

Dear customers, as this warranty card is an important certificate to apply for our maintenance service, please fill in the following form in coordination with the seller and safe-keep it. Thank you!

Product Information	Model	Product Code Number
Customer Information	Name	Contact Number
	Address	
Seller Information	Name	
	Contact Number	
	Address	
	Date of Sale	
Note		

Note: This form shall be sealed by the seller.

Applicable Products

The document applies to the products listed on the Product Maintenance Information (see below for further information). Other products or accessories (e.g. promotional items, giveaways and additional accessories attached, etc.) are not included in this warranty scope.

Warranty Period

The warranty period of products and accessories is implemented according to the relevant Product Maintenance Information. The warranty period is calculated from the day (purchase date) when the product is bought for the first time, and the purchase date is considered as the date registered on the warranty card when buying the product.

How to Get the Maintenance Service

If maintenance service is needed, you can directly contact the product distributor or authorized service institutions. You can also contact the Godox after-sale service call and we will offer you service. When applying for maintenance service, you should provide valid warranty card. If you cannot provide valid warranty card, we may offer you maintenance service once confirmed that the product or accessory is involved in the maintenance scope, but that shall not be considered as our obligation.

Inapplicable Cases

The guarantee and service offered by this document are not applicable in the following cases: ① The product or accessory has expired its warranty period; ② Breakage or damage caused by inappropriate usage, maintenance or preservation, such as improper packing, improper usage, improper plugging in/out external equipment, falling off or squeezing by external force, contacting or exposing to the improper temperature, solvent, acid, base, flooding and damp environments, etc; ③ Breakage or damage caused by non-authorized institution or staff in the process of installation, maintenance, alternation, addition and detachment; ④ The original identifying information of product or accessory is modified, alternated, or removed; ⑤ No valid warranty card; ⑥ Breakage or damage caused by using

illegally authorized, nonstandard or non-public released software; ⑦ Breakage or damage caused by force majeure or accident; ⑧ Breakage or damage that could not be attributed to the product itself. Once met these situations above, you should seek solutions from the related responsible parties and Godox assumes no responsibility. The damage caused by parts, accessories and software that beyond the warranty period or scope is not included in our maintenance scope. The normal discoloration, abrasion and consumption are not the breakage within the maintenance scope.

Maintenance and Service Support Information

The warranty period and service types of products are implemented according to the following Product Maintenance Information:

Product Type	Name	Maintenance Period(month)	Warranty Service Type
Parts	Circuit Board	12	Customer sends the product to designated site
	Battery	3	Customer sends the product to designated site
	Electrical parts e.g.battery charger, etc.	12	Customer sends the product to designated site
Other Items	Flash tube, power cord, sync cable,modeling lamp,lamp body, lamp cover,lockingdevice, package, etc.	No	Without warranty

Godox After-sale Service Call +86-755-29609320(8062)