



Godox

Ver. EN04 TH20240326601 601_384

CONTINUOUS LIGHTING







Godox

GODOX Photo Equipment Co.,Ltd.

Factory Add: 4th Floor of Building 1, 1st to 4 th Floor of Building 2, 4th Floor of Building 3,1st to 4th Floor of Building 4, Yaochuan Industrial Zone, Tangwei Community, Fuhai Street, Bao'an District, Shenzhen 518103, China

TEL: +86-(0)755-25701197,25726373 FAX: +86-(0)755-25723423 Email: godox@godox.com

| Godox.com

 godoxglobal  GODOX Global  godoxphotoequipment  GODOX Photo  godoxofficial

2024 **4th** EDITION



EMBRACE CREATIVE POSSIBILITIES

At Godox, we believe every creative idea worth exploring. That's why Godox is always with the creative minds, providing them with tools they need to explore their creativity, start their business, and pursue their dreams.

Since 1993, Godox has been dedicated to developing and delivering great and accessible lighting and audio solutions for photographers, videographers, filmmakers, and all potential creators. Godox is always moving forward to push the boundaries of technology. Adhere to our mission, Godox constantly brings innovative and professional products to the industries.

Embrace creative possibilities as more than just a tagline, we hope to empower every creative mind from every corner of the world, regardless of different careers or cultural backgrounds, giving them a chance to explore, create, express, and inspire the world.

CONTENTS



Director Jameson Brooks

04 • COB Lights

UL150II / UL150IIBi
ML30 / ML30Bi
ML60IIBi
SL60IID / SL60IIBi
SL100D / SL100Bi
SL150III / SL150IIIBi / SL200III / SL200IIIBi / SL300III / SL300IIIBi
SL150R / 300R

24 • Focusing Lights

S30
S60 / S60Bi

32 • Panel Lights

LDP8D / LDP8Bi / LDP18D / LDP18Bi
LDX50R / LDX50Bi / LDX100R / LDX100Bi
LED1000IID / LED1000IIBi
LEDP120C / LEDP260C

39 • Foldable LED Mat

FH50R / FH50Bi
FL60 / FL100 / FL150S / FL150R

44 • Hybrid Flash LED Lights

FV150 / FV200
LF308

48 • RGBWW Tube Lights

TL30
TL60
TL120
TL180

57 • Light Sticks

LC500mini / LC500Rmini
LC500R(GBWW)
LC500
LC1000R / LC1000Bi

64 • Dive Lights

WT25D / WT40D / WT60D
WT25R / WT40R / WT60R (RGBWW)

68 • Streaming Lights

ES30
ES45
LR120 / LR150
LR160 / LR180
CL10

77 • Waterproof Lights

WL4B
WL8P

80 • Smartphone Lightings

R1 (RGBWW)
M1 (RGBWW)
LEDM32 / LEDM150

83 • LITEMONS Series

LC30D / LC30Bi
LED6R(GBWW) / LED6Bi
LA150D / LA150Bi / LA200D / LA200Bi

90 • Godox Control

APP Control
Remote Control
Wireless DMX Control

94 • Lens & Gobos

Fresnel Lens System
Spotlight Attachment
Projection Attachment
Projection Attachment Adapter

104 • Accessories

Softbox Series
Lighting Stands & Mounting
Carrying Bags

COB Lights



Silent LED Light

UL150II / UL150IIBi



The Godox innovative fanless cooling lights have evolved to bring you an extraordinary lighting experience. Based on the silent cooling design, they were upgraded with an advanced control box, added with a bi-color option, and designed with DMX control, FX effects, and all the ergonomic details.

Key Features

- Incredible fanless running, ensuring a crystal clear shooting environment even at maximum output.
- Come with a bi-color option, letting you adjust smoothly between warm and cool white.
- Control box with intuitive interface, versatile power supply system, and the special clamp for secure and convenient installation.
- 4 optional dimming curves including Exp, Linear, Log, and S-curve.
- Exceptional color rendering, with CRI rating of 96 and TLCI rating of 97.
- 7 built-in FX effects for UL150IIBi and 4 for UL150II.
- Multiple control methods including Remote, Godox 2.4G wireless, DMX, and remote control.
- Selectable AC or DC power supply.
- Bowens mount for wide compatibility.



Silent LED Light

UL150II / UL150IIBi

The Godox innovative fanless cooling lights with the elaborate cooling system allows for efficient and reliable heat-dissipation without built-in fans, making the recording process absolutely silent.



Tech Specs

Model	UL150II	UL150IIBi
Power	Max.160W	Max.180W
AC Power Input	AC100-240V ~ 50/60Hz	AC100-240V ~ 50/60Hz
DC Power Input	DC 48V	DC 48V
Light Head Input	65V/2.3A	39V/3.9A
V-mount Battery (optional) Specifications	14.8V, 150Wh/26V, 270Wh	14.8V, 150Wh/26V, 270Wh
Channel	32 (1 ~ 32)	32 (1 ~ 32)
Group	16 groups (0~9, A~F)	16 groups (0~9, A~F)
ID	1 ~ 99, OFF	1 ~ 99, OFF
Color Temperature	5600K	2800K-5600K
CRI	≥96	≈96
TLCI	≥97	≈97
Working Environment Temperature	-20 ~ 40 °C	-20 ~ 40 °C
FX Light Effect	12 kinds within 4 types	21 kinds within 7 types
Controlling Method	Support DMX512, 2.4G Wireless Control, Bluetooth Control, Controller	Support DMX512, 2.4G Wireless Control, Bluetooth Control, Controller
Dimming Curve	4 types: linear/S-curve/exponential/logarithmic	4 types: linear/S-curve/exponential/logarithmic
Mute Mode	YES	YES
Bluetooth Transmission Distance	≈30m	≈30m
2.4G Wireless Control Distance	≈60m	≈60m
Light Body Dimension	316.9*217.8*170mm	316.9*217.8*170mm
Controller Dimension	270.4*123.6*132mm	270.4*123.6*132mm
Light Body Weight	≈3.11kg	≈3.13kg
Controller Weight	≈2.66kg	≈2.79kg
Bluetooth Transmission Frequency	2402.00-2480.00MHz	2402.00-2480.00MHz
Maximum Transmit Power	5dbm	5dbm
2.4G Frequency Range	/	2412MHz - 2464.5MHz

Silent LED Light

UL150II / UL150IIBi



Dainty LED light

ML30 / ML30Bi



Bi-color
ML30Bi: 2800-6500K

Godox Light

Silent Mode

Battery & DC

FX
ML30: 12 FX
ML30Bi: 21 FX

ML30 and ML30Bi are the smallest COB lights in Godox lighting range, just like a portable flashlight on call at any minutes! Wherever you are, you can instantly use them to back up the lighting, power your work with minimal space taking. What surprises most is the completeness and versatility that comes with accessories system, including Diffusion Dome, Soft Tent, Softbox, offering various light effects to inspire more. Explore lots of fun in your filming journey with ML30 and ML30Bi!



Key Features

- ML30 & ML30Bi are lightweight with palm-sized but powerful LED source.
- Battery powered option with handheld grip makes them handy gears for run and gun shoot.
- Nearly as the size of a mug cup they take up little space, ML30 & ML30Bi are perfect for lighting up in a small studio.
- ML30Bi offers smooth adjustment between 2800K and 6500K to match the ambience for a natural look.
- Scoring over 96 on CRI and 97 on TLCI, ML30 series reproduce accurate colors and thus illuminate your scene a naturally way.
- Silent mode supports creation in sound-sensitive environments
- Wireless control by Godox Light APP

Recommend to

Videographers who shoot run and gun; Content creators who work without assistants; Producers who work on fast-paced projects; Indie filmmakers who need mobile fill light. Any locations you favor.

ML-CD15 & ML-CS1625 are designed with distinctive features to elevate your lighting experience in all rounds for light softness, variable light effects, setup time and even portability.



Collapsible Diffusion Dome Kit ML-CD15 (included 3 adapters)

Collapsible Soft Tent Kit ML-CS1625 (included 3 adapters)

One for Universal Pair

1+3 = ∞

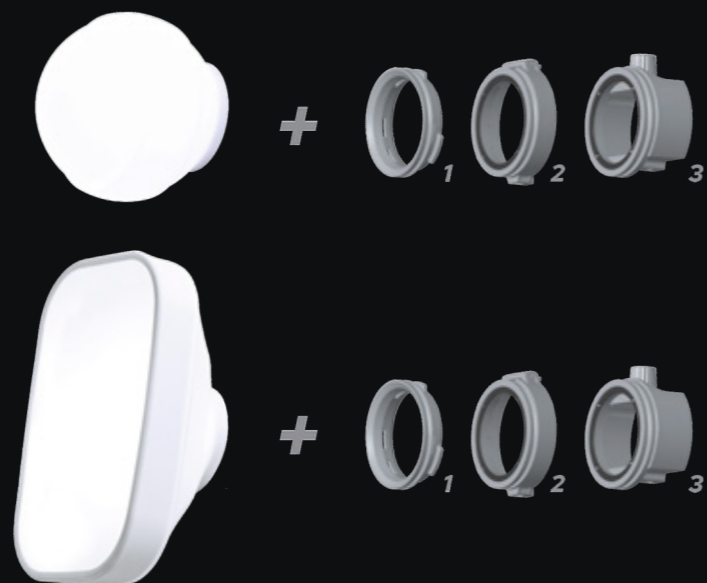

- 1. Godox mount adapter to work with all Godox mount lights
- 2. Round head adapter to work with all round head speedlights like Godox V1 series
- 3. Rectangle to round head adapter to work with most rectangle speedlights

Soft material as a new choice makes them lightweight and flexible in shape, easily to be squeezed as small as possible for storage or transportation.



Collapsible design opens several ways to shape light. Use diffusion dome in fully extension for 360-degree lighting, or collapses the back to diffuse at 180 degrees, and when collapsing the front, you can change the light quality for more dimensionality.

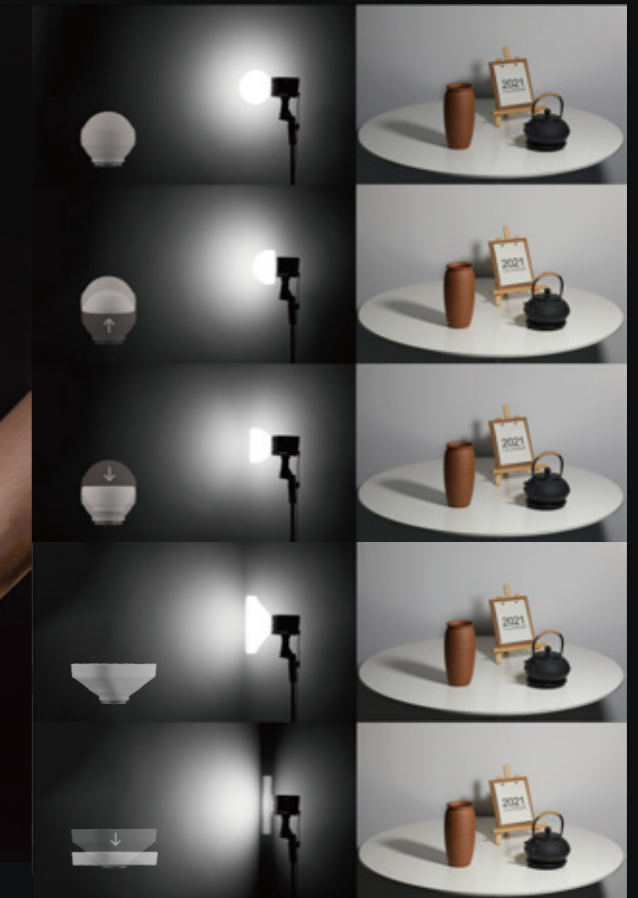

More Accessories



Tech Specs

LED Light	ML30	ML30 Bi
Adapter	14.0V 3.4A	
Output Power	37.6W	40W
Brightness Adjusting Range	0% -100%	
CRI(=)	96	
TLCI(=)	97	
Color Temperature	5600K	2800 - 6500K
Lighting Effects Mode	A total of 12 types in 4 categories	A total of 21 types in 7 categories
Bluetooth Transmission	15 meters	
BT Frequency Range	2402.0- 2480.0MHz	
Max. Transmitting Power	5dbm	
Working Temperature	-10~-40°C	
Weight (not include handle and reflector)	587g	602g
Dimension (not include handle and reflector)	120*88*88mm	

ML30 / ML30Bi Two Light Kits

ML30 / ML30Bi



Want to get professional video looks from a set of lightweight budget gears? Two-light kit of ML30 series is the way to go. Work team of any scale including individual creator could easily handle the setup work with no assistant for efficient lighting.

ML30-K2 / ML30Bi-K2

1. ML30/ML30Bi Light	× 2
2. Reflector	× 2
3. Protect Cover	× 2
4. Grip	× 1
5. Tripod Adapter ML-TA1	× 2
6. Collapsible Soft Tent ML-CS1625	× 1
7. Collapsible Diffusion Dome ML-CD15	× 1
8. Adapter Holder	× 2
9. Battery Case BC60	× 1
10. Adapter	× 2
11. Softbox ML-SF3030	× 2
12. 5m AC Power Cable	× 2
13. 0.2m DC Power Cable	× 1
14. 1.5m DC Power Cable	× 1
15. Carry Bag CB32	× 1

ML series Three Light Kits



Three-light kit that comprises ML series is a comprehensive set with light design possibilities. You can decide how each light is positioned in a certain relationship such as the classic three point lighting, or for more diversified effects and styles with your creativity.

ML-Kit1

1. ML60 Light	× 1
2. ML30 Light	× 2
3. Reflector	× 3
4. Protect Cover	× 3
5. Grip	× 1
6. Tripod Adapter ML-TA1	× 3
7. Collapsible Soft Tent ML-CS1625	× 1
8. Collapsible Diffusion Dome ML-CD15	× 1
9. Softbox AD-S65S	× 1
10. Adapter Holder	× 3
11. Battery Case BC60	× 1
12. Adapter	× 3
13. Softbox ML-SF3030	× 2
14. 5m AC Power Cable	× 3
15. 0.2m DC Power Cable	× 1
16. 1.5m DC Power Cable	× 1
17. Carry Bag CB33	× 1

ML-Kit2

1. ML60Bi Light	× 1
2. ML30Bi Light	× 2
3. Reflector	× 3
4. Protect Cover	× 3
5. Grip	× 1
6. Tripod Adapter ML-TA1	× 3
7. Collapsible Soft Tent ML-CS1625	× 1
8. Collapsible Diffusion Dome ML-CD15	× 1
9. Softbox AD-S65S	× 1
10. Adapter Holder	× 3
11. Battery Case BC60	× 1
12. Adapter	× 3
13. Softbox ML-SF3030	× 2
14. 5m AC Power Cable	× 3
15. 0.2m DC Power Cable	× 1
16. 1.5m DC Power Cable	× 1
17. Carry Bag CB33	× 1

ML Series LED Light

ML60IIBi



ML60IIBi

22500Lux 5600K
@1m with standard reflector

2800K-6500K

CRI
96+
CRI 96+

TLCI
97+
TLCI 97+

526g
Lightweight

11 FX
Effects

Godox Light APP
Control

Charging Case
Powered by AC/DC

ML60IIBi—a lightweight marvel weighing in at nearly 500g and boasting a compact size, ensuring effortless portability. Elevate your video creation game with its rich accessories and the MLP projection attachment, offering endless creative possibilities. From outdoor vlogs to indoor spaces, the ML60IIBi can be your perfect companion. Don't miss the opportunity to capture your world in a whole new light.

Key Features

- Super Lightweight & Compact Design
- One-Handed Outdoor Gear
- Smaller Bag Carrying Bigger Convenience
- high CRI/TLCI at 96+/97+
- 2800-6500K Color Temperature Range
- Upgraded Lamp Beads for Stunning Brightness
- 11 built-in FX effects
- Fuel Creativity With Versatile Accessories
- Adaptable Lighting in Any Space
- APP Control



ML Series LED Light

ML60IIBi



Tech Specs

Model	ML60IIBi
Power Supply	20V≈3.5A
Input Power	Max. ≈70W
Brightness Range	0%-100%
CRI	Average≥96
TLCI	Average≥97
CCT	2800-6500K
FX Type	11
Bluetooth Control Distance	Max.30m
Working Environment Temperature	-10°C ~+40°C
Dimension	3.46**3.62**4.38"
Net Weight	≈526g
(Lamp Head Protective Cover Included)≈	

Optional Purchase



ML60IIBi Kit 1

Light Body	x1
Reflector	x1
AD-E2 Bracket	x1
Carry Bag	x1
AC Power Cord	x1
Adapter	x1
Lamp Head Protective Cover	x1
AK-B01 NP-F Battery Accessory Kit	x1



ML60IIBi Kit 2

Light Body	x1
Reflector	x1
AD-E2 Bracket	x1
Carry Bag	x1
AC Power Cord	x1
Adapter	x1
Lamp Head Protective Cover	x1
AK-B02 V-Mount Battery Accessory Kit	x1

Optional Accessories



AK-B01 NP-F Battery Accessory Kit	AK-B02 V-Mount Battery Accessory Kit	ML-CD15 Collapsible Diffusion Dome	ML-CS1625 Collapsible Soft Tent	MLP Projection Attachment	ML-SF3030 Softbox	AD-S60 Softbox
-----------------------------------	--------------------------------------	------------------------------------	---------------------------------	---------------------------	-------------------	----------------

SL Series LED Light

SL60IID / SL60IIBi

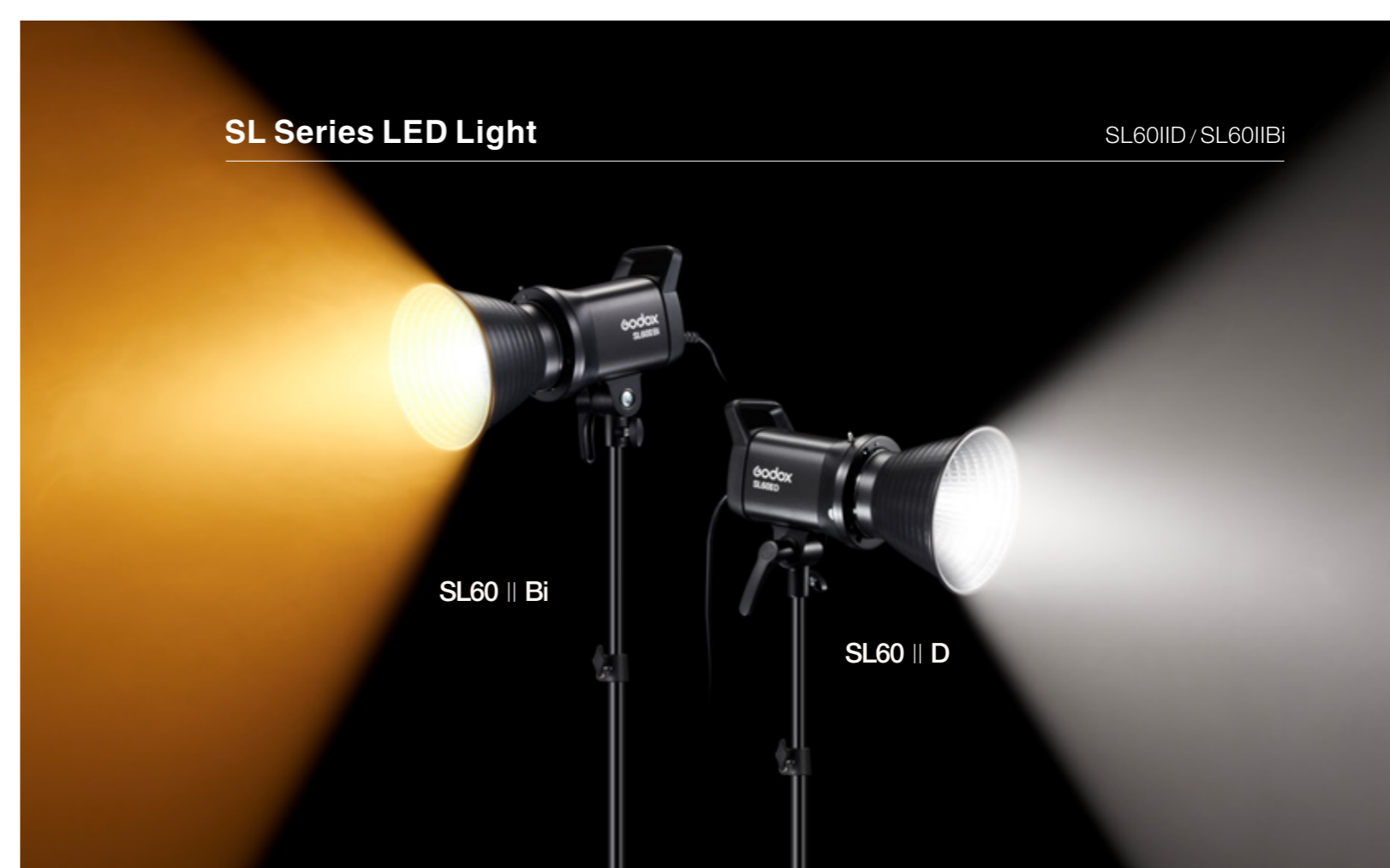

The newly SL60IID and SL60IIBi are updated with stronger output, empowering your ideas. Controlling gets easier by connecting to the APP via Bluetooth. Changing between shooting spots becomes more convenient with its smaller size. Building a diverse ambiance comes more straightforward thanks to the bi-color version.

Key Features

- High maximum output of 18,600 Lux (SL60IID) and 25,100 Lux (SL60IIBi) at 1 meter with standard reflectors.
- Convenient control options including on board control, remote, APP, and DMX.
- Adjustable color temperature range from 2800K to 6500K (SL60IIBi).
- Built-in FX effects with 8 options (SL60IID) and 11 options (SL60IIBi).
- Compatible with a wide range of accessories through the BOWENS mount.
- High color accuracy with CRI/TLCI ratings of 96+/97+.





Tech Specs

Model	SL60IID
Power Supply	100V-240V~50/60Hz 0.7A
Power	Max.70W
CCT	5600±200K
Channel	32
Group	16 (A,B,C,D,E,F,0-9)
ID	1-99/OF
CRI	≥96
TLCI	≥97
FX Type	8
Control Method	2.4GHz Wireless/Bluetooth/Light Body Control
2.4GHz	≈30m
Transmission Distance	
Bluetooth	≈30m
Transmission Distance	
Brightness Range	0%-100%
Working Environment	-10°C-40°C
Temperature	
Dimension	140mm*236mm*215mm (unfolded without reflector)
Net Weight≈	1.43kg

Model	SL60IIBi
Power Supply	100V-240V~50/60Hz 0.75A
Power	Max.75W
CCT	2800k-6500k
Channel	32
Group	16 (A,B,C,D,E,F,0-9)
ID	1-99/OF
CRI	≥96
TLCI	≥97
FX Type	11
Control Method	2.4GHz Wireless/Bluetooth/Light Body Control
2.4GHz	≈30 meters
Transmission Distance	
Bluetooth	≈30 meters
Transmission Distance	
Brightness Range	0%-100%
Working Environment	-10°C-40°C
Temperature	
Dimension	140mm*236mm*215mm (unfolded without reflector)
Net Weight≈	1.5kg



For those pursuing the best power out of limited budget, Godox has SL100D and SL100Bi for you. Compact unit with high brightness, SL100 twins work well for small space lighting. Daylight SL100D as basic solution while the Bi-color SL100Bi for more creativity. Bowens mount makes it easier to choose accessories. Want to gain popularity as a Youtuber, live streamer, content creator or commercial producer, Lighting with SL100 will be a good start.



Key Features

- Dependable 5600K SL100D and variable (2800-6500K) SL100Bi feature a high CRI/TLCI rating of 96/97 that translates to advanced accuracy in color rendering.
- SL100D offers Lightning 1/2/3, Flash, Conference, Paparazzi, Television, and Broken Bulb , and based on that SL100Bi has 3 additional light effects: Candle, Fire, Firework.
- With its compact design, you can freely use it in home or small studio settings.
- Bowens front accessory mount allows use of Godox modifiers and those of the many manufacturers that use this popular mount.
- Dual dials and clearly marked buttons offer intuitive user interface
- The SL100D/SL100Bi functions can be adjusted on the fixture, with a smartphone using the *Godox Light* App, or with an optional wireless remote.

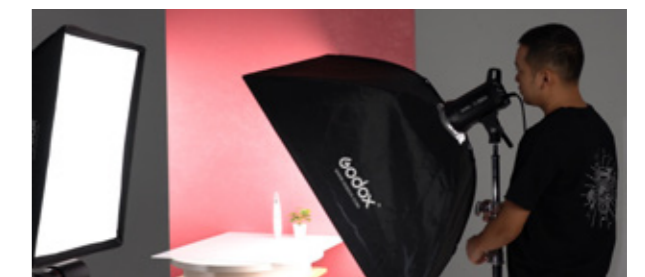

Tech Specs

LED Light	SL100D	SL100Bi
Power Supply	AC100V-240V (50/60Hz)	
Output Power	100w	
Channel	32	
Group	16(0-9/A B C D E F)	
ID	OFF/1-99	
Color Temperature	5600K	2800K-6500K
Light Adjustment Range	0%~100%	
100% Illuminance(LUX) (with standard reflector, testing distance, 1m)	≈32100	
CRI	≥96	
TLCI	≥97	
Temperature of Working Environment	-10° - 40°	
Light Effect Mode	8	11
Control Method	Smartphone APP/2.4G Wireless	
Bluetooth Transmission Distance	≈30m	
2.4G Wireless Transmission Distance	≈30m	
Beam Angle	120°	
Dimension	243*205*127mm	

SL Series LED Light

SL100D/SL100Bi

SL100D-K2

SL100D x2
304 Light Stand x2
SB-BW-6090 Softbox x2
RC-A6 Remote Control x1
CB-04 Carrying Bag x1



SL100Bi-K2

SL100Bi x2
304 Light Stand x2
SB-BW-6090 Softbox x2
RC-A6 Remote Control x1
CB-04 Carrying Bag x1



SL Series LED Video Light

SL150III / SL200III / SL300III
SL150IIIBi / SL200IIIBi / SL300IIIBi



SL Series LED Video Light

SL150III /SL200III/SL300III
SL150IIIBi/SL200IIIBi/SL300IIIBi



While Godox always keeps pursuing progress, the SL series has evolved to provide a more convenient and efficient experience. Inheriting the excellent quality and performance of the predecessor, now the SLIII (SL150III/SL150IIIBi/SL200III/SL200IIIBi/SL300III/SL300IIIBi) comes with the added Godox Light App control, offering you more flexibility on set. It's an ideal solution for live streaming, broadcasting, and other video applications.

Key Features

- Stepless adjustment from 0% to 100%.
- Optional Daylight version or Bi-color version.
- Silent mode especially suitable for sound-sensitive applications.
- High CRI/TLCI rating ≈ 96/97
- The rotatable U-shaped yoke offers excellent flexibility and can be used with most light stands.
- Multiple control methods including onboard control, wireless remote control and Godox Light App control.
- Built-in FX effects.
- Bowens mount for wide compatibility.

Tech Specs

Model	SL150III	SL200III	SL300III
Power Supply	100V-240V ~50/60Hz	100V-240V ~50/60Hz	100V-240V ~50/60Hz
Output Power	Max. 160W	Max. 215W	Max. 330W
CCT	5600K±200K		
TLCI	≈97		
CRI	≈96		
Brightness Range	0%-100%		
Channel	32 (1-32)		
Group	16 (A, B, C, D, E, 0-9)		
ID	99 (01-99)		
Control Method	2.4GHz Control/Bluetooth APP Control/ Light Body Control		
2.4GHz Control Distance	≈50m		
Bluetooth Control Distance	≈30m		
Working Environment	-10°C~40°C		
Temperature			
Dimension (excluding reflector)	34×20×16cm	36.7×20×16cm	36.2×19.4×31cm
Net Weight	≈2.8kg	≈3kg	≈3.6kg

Model	SL150IIIBi	SL200IIIBi	SL300IIIBi
Power Supply	100V-240V ~50/60Hz	100V-240V ~50/60Hz	100V-240V ~50/60Hz
Output Power	Max. 160W	Max. 215W	Max. 330W
CCT	2800K-6500K		
TLCI	≈97		
CRI	≈96		
Brightness Range	0%-100%		
Channel	32 (1-32)		
Group	16 (A, B, C, D, E, 0-9)		
ID	99 (01-99)		
Control Method	2.4GHz Control/Bluetooth APP Control/ Light Body Control		
2.4GHz Control Distance	≈50m		
Bluetooth Control Distance	≈30m		
Working Environment	-10°C~40°C		
Temperature			
Dimension (excluding reflector)	19.9×28.5× 28.8cm	19.9×31.1× 29.5cm	19.9×35.6× 31.6cm
Net Weight	≈3.1kg	≈3.25kg	≈3.59Kg

SL Series LED Video Light

SL150R/300R

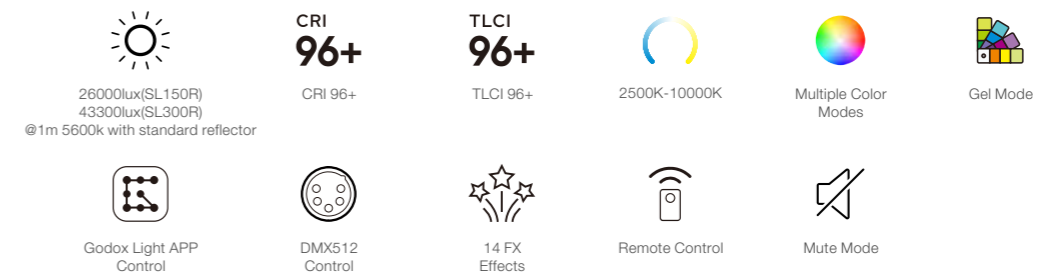

Get ready for the SL150R/300R from the SL series. Access versatile lighting effects with a Bowens mount and take control of diverse lighting effects using CCT, HSI, RGB, GEL modes, empowered by RGBWW technology for enhanced color rendition. Ensure noise-free shooting with the mute mode. The SL150R/300R offers compact yet powerful solutions for a range of scenes, from live stream studios and interviews to theater stages.

Key Features

- Powerful Output
- Designed in a compact construction
- 2500K-10000K
- High CRI/TLCI at 96+(SL300R)
- 14 FX Effects
- Experience versatile lighting effects with the Bowens mount
- Take complete control of your color palette with HSI, RGB, and GEL modes
- Enjoy noise-free shooting with the mute mode
- Customize your lighting with ease using DMX512, remote control, APP, or the light body

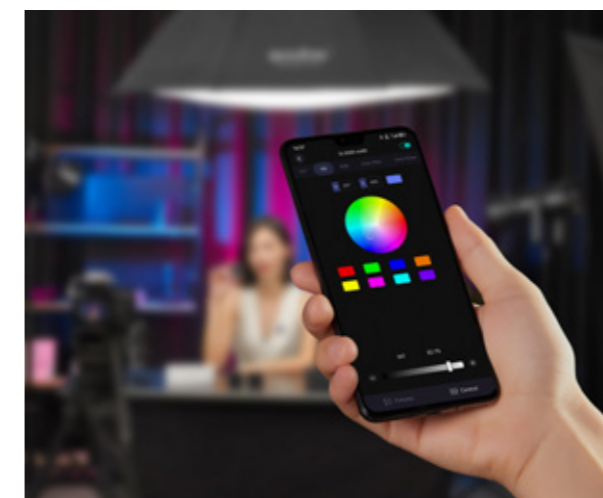



Tech Specs

Model	SL150R	SL300R
Power Supply	36V=4.6A	52V=5.7A
Input Power	Max. ≈165W	Max. ≈310W
CCT	2500-10000K	
Brightness Range	0%-100%	
FX Type	14	
CRI	Average≥95	
TLCI	Average≥96	
CH	32(1-32)	
GR	16(A-F 0-9)	
ID	99(1-99)	
Mode	CCT CCT mode/HSI mode/RGBW mode GEL mode/FX mode	
Controlling Mode	2.4G wireless control/DMX 512 control Bluetooth control/light body control	
2.4G Controlling Distance	Max.50m	
Bluetooth Controlling Distance	Max.30m	
U-type Bracket Adjustment Angle	360°	
Working Environment Temperature	-10°C ~+40°C	
Dimension	288*199*283mm	315*199*342mm
Net Weight	2.35kg	2.77kg



TRAIN STATION
Godox

WAY OUT EXIT

SHINE

FOCUSING LIGHTS

Photographer: Luke Edmonson, David Edmonson



S30

The focusing LED light S30 is a suitable light source for video lighting, interviewing, headshot, still life photography, portrait, wedding photography, and pre-wedding photography, and also a good choice for enthusiasts who want creative lighting.

Key Features

Outstanding Lighting Effects

- An aspheric optical lens gives S30 with a CRI and TLCI rating of 96+, S60 CRI/TLCI ratings of 96+/97+ and guarantees natural, pristine color in any application.

Precise Control of Light Coverage

- With a beam angle from 6 to 55 degrees, you can get the output spread size you need by adjusting the rotary knob on the back. An optional projecting lens makes it useful lighting details.

Multiple Options of Power Supply

- Three ways of power supply offer great convenience for S30, portability and wide application

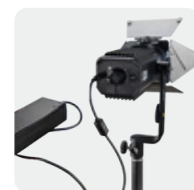

Power supplied by DC adapter (15V/4A)

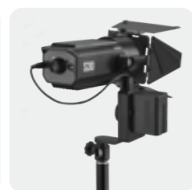

Power supplied by Li-ion battery (Sony NP-F970/F950/F930) (7.4V)



Power supplied by power bank with a USB cable(5V/2A)

Even and Smooth Beam (with projection attachment)



Tech Specs

LED Light	S30
Power Supply	DC adapter 15V/4A Power 30W Li-ion battery(Sony NP-F970/F950/F930) 7.4V Power 10W Power bank with a USB cable 5V/2A Power 10W
Output Power	30W
Color Temperature	5600K±150K
Beam Angle	6°~55°
100% Illuminance (LUX)1m, dark room	Flood(Central Area)≈ 2800 Spot (Central Area)≈ 11300
CRI	96
TLCI	97
Brightness Range	10%~100%
Channel, Group	-
Operation Temperature	-10~50°C
Net Weight (≈)	907 g
Dimension (≈)	215*108*100mm



S60



S60 Bi

Beam angle from 6 to 55 degrees, you can get the ideal spotlight size by adjusting the rotary knob on the back. With a projecting lens (optional) light can be focused at its extreme. This controllability makes S60 series perfect for lightening any details.

Key Features

- Beam angle from 6 to 55 degrees, light where you want
- Variable Color Temperature
- High color rendering CRI/TLCI rating of 96+/97+
- Lighting FX
- Silent mode
- Control by Godox Light app, remote RC-A6 or DMX

More Features of S60 Series

Multiple Control Methods

- With a built-in Bluetooth system, the S60 can be remotely adjusted for the setting on the user-friendly "Godox Light" app. It also supports optional RC-A6 wireless remote control.



DMX Godox Light RC-A6

Silent Mode

- In the silent mode, the fan is turned off to avoid any acoustic disturbance for sound sensitive environments. (light intensity is decreased by half when the fan is turned off)



Illuminance Data of S60Bi

Color Temperature	Testing Condition	Illuminance Data			
		1m	2m	3m	
2800K	flood	lux	3010	761	352
		fc	280	70.7	32.7
	spot	lux	22400	5920	2740
		fc	2090	550	254
3200K	flood	lux	3710	950	436
		fc	345	88.2	40.5
	spot	lux	28000	7430	3410
		fc	2600	690	317
4300K	flood	lux	4310	1100	505
		fc	400	102	47
	spot	lux	32700	8690	3970
		fc	3030	807	369
5600K	flood	lux	4340	1110	509
		fc	403	103	47.3
	spot	lux	32900	8770	4000
		fc	3060	815	372
6500K	flood	lux	4290	1100	504
		fc	398	102	46.8
	spot	lux	33200	8690	3960
		fc	3090	808	368



Tech Specs

Model No.	S60Bi	S60
Power Supply	AC Power Supply 100~240V 50/60HZ 0.9A MAX V-port battery Standard voltage: 14.8V (optional)	AC: 100~240V 50/60Hz 0.9A V-port battery standard voltage 14.8V(optional)
Output Power	77W (Max)	60W
Color Temperature	2800-6500K	5600K±300K
100% Illuminance(LUX) (1m, darkroom) (=)		Flood(Central Area) 3200 Spot(Central Area) 4000
CRI	≈96	≥96
TLCI	≈97	≥97
Brightness Range	0~100%	0~100%
Channel(CH)	32 (1 to 32)	32 channels(1 to 32); 16(A to F/ 0 to 9)
Group (GR)	16 (A to F/ 0 to 9)	
Beam Angle	6°-55°	
Working Environment Temperature	-10~40°C	-10~40°C
Control Method	Smartphone APP/ 2.4G wireless /remote/ control/DMX control	
2.4G Wireless Transmission Distance(≈)	50m	
Dimension(≈)	Light body: 264*107*100mm Controller: 233*112*61mm	Light body 264*107*100mm Controller 268*113*64mm
New weight(≈)	Light body: 1.36kg Controller: 1kg	Light body 1.36kg; Controller 0.94kg

Abundant Accessories

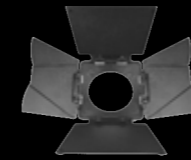

SA-08 Barndoor Set

Barndoor set: to precisely control the light beam as required. There are small clips on the plate for clipping diffusion fabric or gels on.

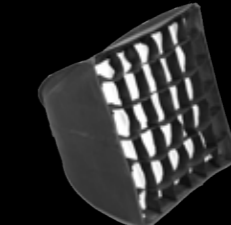

SA-30 / SA-20 Softbox

Offers soft and even light effects

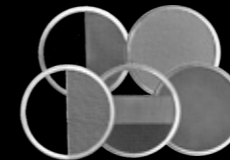

SA-05 Scrim set

To reduce the light intensity and control the light graduation.



SA-07 Scrim set

To reduce the light intensity and control the light graduation.



Projection attachment: project a highly focused and controlled beam of light. This attachment is what enables you to get the utmost out of creativity of Focusing light series for it is specially designed for fitting a vast range of light shaping accessories.



SA-P Projection Attachment (included a SA-01 85mm Lens)



SA-01 85mm Lens



SA-02 60mm Wide-angle Lens



SA-03 150mm Telephoto Lens

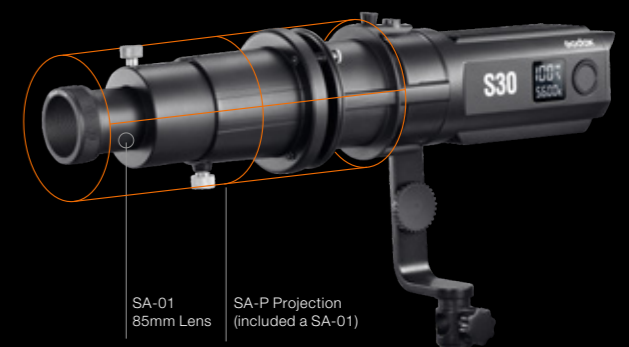

SA-01 85mm Lens

SA-P Projection (included a SA-01)



SA-06 Iris Diaphragm

By pushing its lever the range of light beam can be gradually adjusted, from a small spot that could be captured by your hand to the original size.



SA-09 GOBO set

By inserting the Gobo into the projection attachment, different patterns can be projected to form various background. You can even have the gobo customized to design your own pattern.

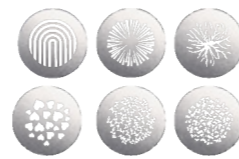

SA-11C / SA-11T Colors gels

To color the light for unique atmosphere.



S30/S60 focusing light series is born for the diversity of light designing. With all the light shaping accessories, you can tailor the light into whatever patterns you like by bringing into your own creative thoughts.



S30-D Three-light kit

Light Head	x3
Wrench	x1
Power Cord	x3
Connect Cable	x3
Controller Box	x3
SA-30 Softbox	x2
SA-05 Scrim Set	x1
SA-06 Iris Diaphragm	x1
SA-07 Framing Shutter	x1
SA-08 Barndoor Set	x3
SA-09 GOBO Set	x1
SA-10 GOBO Holder	x1
SA-11C Color Filters of Color Effects Set	x1
SA-11T Color Filters of Color Temperature Adjustment Set	x1

SA-P Projection Attachment (included a SA-01 85mm lens)	x1
213B Light Stand	x3
Remote Control RC-A6	x1
CB14 Carrying Bag for Light Stand	x1
CB21 Carrying Case for Kit	x1



S60-D Three-light Kit

1.Light Head	x3
2.Wrench	x1
3.Power Cord	x3
4.Connect Cable	x3
5.Controller Box	x3
6.SA-30 Softbox	x2
7.SA-05 Scrim Set	x1
8.SA-06 Iris Diaphragm	x1
9.SA-07 Framing Shutter	x1
10.SA-08 Barndoor Set	x3
11.SA-09 GOBO Set	x1
12.SA-10 GOBO Holder	x1
13.SA-11C Color Filters of Color Effects Set	x1
14.SA-11T Color Filters of Color Temperature Adjustment Set	x1
15.SA-P Projection Attachment (included a SA-01 85mm lens)	x1
16.CB21 Carrying Case for Kit	x1
17.Remote Control RC-A6	x1
18.213B Light Stand	x3
19.CB14 Carrying Bag for Light Stand	x1

S60Bi-K3 Three-light Kit

1.Light Head	x3
2.Wrench	x1
3.Power Cord	x3
4.Connect Cable	x3
5.Controller Box	x3
6.SA-30 Softbox	x2
7.SA-05 Scrim Set	x1
8.SA-06 Iris Diaphragm	x1
9.SA-07 Framing Shutter	x1
10.SA-08 Barndoor Set	x3
11.SA-09 GOBO Set	x1
12.SA-10 GOBO Holder	x1
13.SA-11C Color Filters of Color Effects Set	x1
14.SA-11T Color Filters of Color Temperature Adjustment Set	x1
15.SA-P Projection Attachment (included a SA-01 85mm lens)	x1
16.CB52 Carrying Bag for Light Stand	x1
17.Remote Control RC-A6	x1
18.213B Light Stand	x3
19.CB51 Carrying Case for Kit	x1



Panel Lights



LED Video Light

LDP8D/8Bi/18D/18Bi



To brighten your subjects on location, the LDP series LED light is a sleek and lightweight option that fits snugly onto your camera. Its innovative side-mounted chip design delivers an extremely soft light that adds a touch of magic for filming vlogs, weddings, foods, etc. It is a must-have tool for those seeking to present creativity while staying nimble and free.

Key Features

- The unique mounted LED chips make the emitted light even softer.
- Enjoy the ultra-light design for easy shooting on location.
- High color accuracy with TLCI ratings of 95+.
- Adjustable color temperature ranges from 2800K to 6500K (LDP8Bi/18Bi).
- Built-in FX effects with 22 options (LDP8D/18D) and 31 options (LDP8Bi/18Bi).
- Stable output with 0% to 100% brightness range.
- Support DC power supply/NP-F battery power supply.



Tech Specs

Model	LDP8D	LDP18D
DC Inputs	5V=2A	12V=2A
Input Power	≈10W	≈21W
Power Supply	DC power supply/NPF battery power supply (NPF battery is sold separately)	
Brightness	0%-100%	
Ra	average ≥92	average ≥95
TLCI	average ≥97	average ≥95
Working Environment	-10°C~40°C	
Temperature		
CCT	5600k	
Dimension	147*105*33mm	210*149*31mm
Net Weight≈	194g	363g

Tech Specs

Model	LDP8Bi	LDP18Bi
DC Inputs	5V=2A	12V=2A
Input Power	≈10W	≈22W
Power Supply	DC power supply/NPF battery power supply (NPF battery is sold separately)	
Brightness	0%-100%	
CRI	average ≥96	average ≥96
TLCI	average ≥98	average ≥97
Working Environment	-10°C~40°C	
Temperature		
CCT	2800-6500k	2800-6500k
Dimension	147*105*33mm	210*149*31mm
Net Weight≈	194g	363g

RGBWW Panel Light

LDX50R/50Bi/100R/100Bi



LDX50Bi/R and LDX100Bi/R come to elevate your lighting experience. With the detachable diffuser, you can easily adjust the lighting ambiance from soft to high-intensity. The lights have metal casings that eliminate light noise and ensure long-lasting durability. With a diverse array of vibrant color modes, the RGBWW version helps ignite your imagination. Embark on an extraordinary journey of creativity as the LDX series lights set your creativity a blaze.

Key Features

- Detachable diffuser for customizable lighting options.
- The metal structure on the back ensures heat dissipation without noisy fans and enhances durability for long-term usage.
- Bi-color version with five preconfigured color temperatures (2800k/3200k/4300k/5600k/6500k) for easy application.
- Adjustable color temperature range: 2800K to 6500K (LDX50Bi/100Bi) and 2500K to 10000K (LDX50R/100R).
- Built-in FX effects with 11 types (LDX50Bi/100Bi) and 14 types (LDX50R/100R).
- Convenient control options: panel, remote control, and APP.
- Multiple power supply options: NP-F battery, V-mount battery, and DC power.



Tech Specs

Model	LDX50R	LDX100R
Power Supply	20V=3.5A	20V=6A
Total Power	Max.63W	Max.118W
CCT	2500K-10000K	
Brightness Range	0%-100%	
FX Type	14	
CRI	Average≥96	
TLCI	Average≥96	
Channel	32(1-32)	
Group	16(A-F, 0-9)	
ID	99(1-99)	
Controlling Method	2.4G remote control/Bluetooth APP Control/ Light body control	
2.4G Controlling Distance	Max.50m	
Bluetooth Control Distance	Max.30m	
U-type Bracket Adjustable Angle	360°	
Working Environment Temperature	-20°C~+40°C (in DC power supply)	
Dimension	357*305*75mm	417*468*63mm
Net Weight≈	1.86kg	3.24kg

Tech Specs

Model	LDX50Bi	LDX100Bi
Adapter Output	20V=3.5A	20V=6A
Total Power	Max.65W	Max.120W
CCT	2800K-6500K	
Brightness Range	0%-100%	
FX Type	11	
CRI	Average≥96	
TLCI	Average≥96	
Channel	32(1-32)	
Group	16(A-F, 0-9)	
ID	99(1-99)	
Controlling Method	2.4G remote control/Bluetooth APP Control/ Light body control	
2.4G Controlling Distance	Max.50m	
Bluetooth Control Distance	Max.30m	
U-type Bracket Adjustable Angle	360°	
Working Environment Temperature	-20°C~+40°C (in DC power supply)	
Dimension	357*305*75mm	417*468*63mm
Net Weight≈	1.85kg	3.26kg

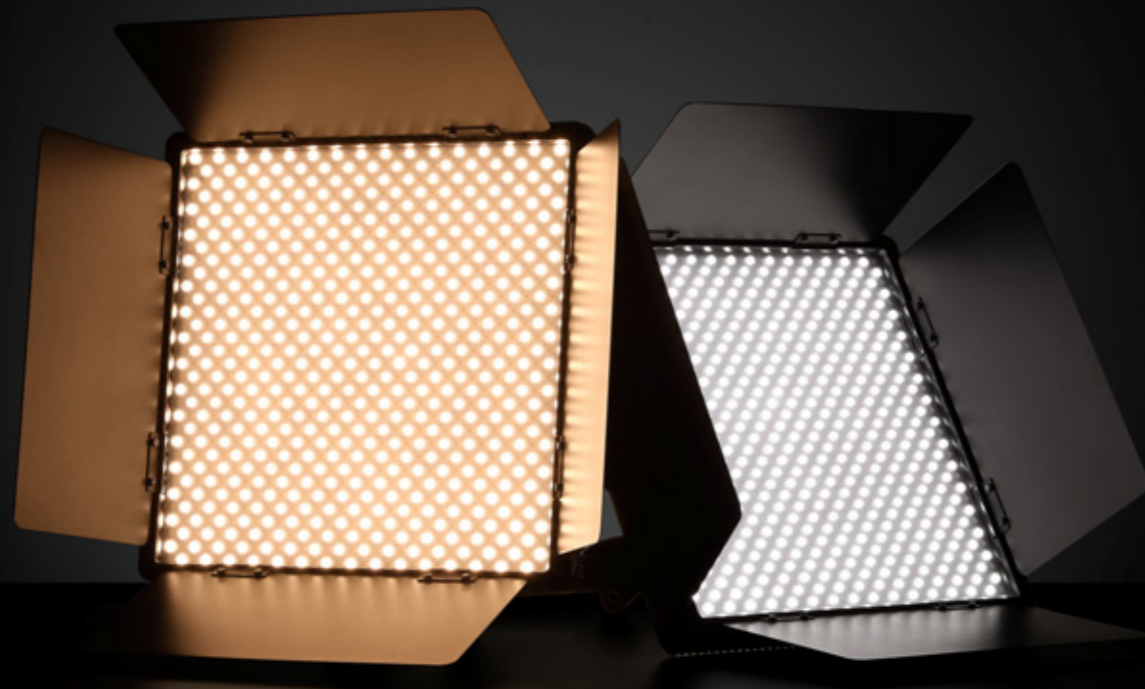

LED1000Bi II

LED1000D II

LED1000D II/LED1000Bi II video lights are excellent for product shooting, photojournalistic and video recording, etc. It provides a wide spectrum, beautifully soft and even illumination for photography.

Key Features

- Premium LED bulbs and wide screen offer high brightness
- Three models create various light effects
- Three control options to wirelessly adjust brightness or color temperature
- Lithium battery or DC charged



* Yellow and blue filters only for LED1000D II

Accurate Color

With a CRI/TLCI rating of 96/98, it produces highly accurate color renditions and delivers pristine and natural results.



Flexible and Versatile

The four reflective barndoors enables to shape and adjust the light for optimal result and protect the bulbs while in storage. Thanks to the yoke, the light can be easily adjust the angle.



Three control options

Control the individual unit or groups either locally on-board control with LCD Panel, wirelessly with the RC-A5II remote control(optional), or via the DMX control system. You are free to control the brightness from 100% to 0% and color temperature (of LED1000Bi II) from 3300K to 5600K and so on in any situation.



(optional)

Tech Specs

LED Video Light	LED1000D II (daylight version)	LED1000Bi II (Bi-color version)
Lithium Battery	14.8V Lithium battery (BP-L model)(sold separately)	
DC Power Supply	13-16.8V	
Channel	16	
Group	6 (A, B, C, D, E, F)	
Power	Max. 70W	
Color Temperature	5600K±300K	3300K-5600K±300K
100% Brightness(Lux)≈	5400 @1m	4800 @1m/4200K 2200 @1m/3300K 2600 @1m/5600K
CRI≈	96	
TLCI≈	98	
Dimming Range	0%~100%	
LED Beads Quantity	1024	5600K: 512 3300K: 512
Operation Temperature	-10~40°C	
Dimension	430*460*100mm	
Net Weight	2.51Kg	
Remote Control	RC-A5 II	
Power Supply	3.0V(AAA*2)(not included)	
Wireless Frequency	433MHz	
Distance (Open Area)	20m	
Channel	16	
Group	6 (A, B, C, D, E, F)	
Standby Time	More than one year	
Operation Temperature	-10~40°C	
Dimension	120*38*15mm	
Net Weight	30g	

LED Panel Light

LEDP120C / LEDP260C



LEDP120C

LEDP260C

The LEDP120C and LEDP260C video light are excellent for macro photography, wedding shooting, product shooting, photo journalistic and video recording, etc. The lightweight and portable light provides high brightness, convenient operation and accurate color temperature.

Key Features

- High-quality LED blubs
- Using lithium battery with great portability
- Soft and even illumination
- Included with a L-type bracket
- Fits almost any cameras and camcorders



Flexibly change angle Adjustable light brightness and color temperature Lightweight and Ultra-thin body

- With the wide spectrum, soft light and accurate color temperature
- Wireless grouping system (6 groups & 16 channels)
- Adjustable light brightness and color temperature
- Lithium battery or DC charged
- Large-sized LCD panel and settings auto saved
- Include a detachable handle and AC adapter

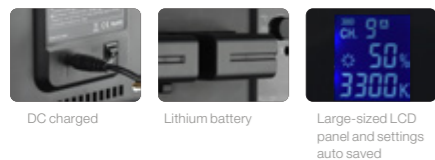

DC charged Lithium battery Large-sized LCD panel and settings auto saved

Tech Specs

LED Light	LEDP120C	LEDP260C
Power Supply	7.4V Lithium Battery (NP-F970 model lithium battery)(optional)	7.4V Lithium Battery (NP-F970 model lithium battery)(optional) DC Power Supply: 13-16.8V
Power	Max.12W	Max.30W
Channel	/	16
Group	/	6(A, B, C,D, E, F)
Color Temperature	3300K-5600K±300K	
Brightness(LUX)	580 (0.5m/4500K)	2050 (0.5m/4500K)
	630 (0.5m/3300K)	2050 (0.5m/3300K)
	680 (0.5m/5600K)	2200 (0.5m/5600K)
Dimming Range	10%~100%	
CRI	≥95	≥95
TLCI	≥95	≥94
Operating Temperature	-10~40°C	
Package Weight	220g	917g
Box Dimensions (LxWxH)	175mm*130mm*17mm (not with the L-type Bracket)	360mm*240mm*27mm

Remote Control	RC-A5
Power Supply	3.0V(AAA*2)(not include)
Wireless Frequency	433MHz
Distance (emptiness)	20m
Channel	16
Group	6 groups (A/B/C/D/E/F)
Standby Time	Over one year
Operation Temperature	-10~50°C
Dimension	120mm*38mm*15mm
Net weight	30g



Flexible Handheld LED Light

FH50R / FH50Bi



FH50Bi

FH50R

The FH50Bi and FH50R flexible handheld LED Lights are compact, lightweight fixtures designed for flexibility. Measuring 1 x 1' and featuring a slim, bendable design, they fit well into tight spaces like car visors, wall corners, etc. High-quality metal frames enable tool-free lighting area adjustments. The lights are handy tools for live streamers, content creators, videographers, and filmmakers who require an adaptable and flexible lighting setup.

Key Features

- Swiftly shape illuminating areas with a secure metal frame after a single bend.
- Ultra-portable handheld design supports your on-the-go shootings.
- Color temperature from 2500K to 10000K(FH50R) and 2800K to 6500K(FH50Bi).
- HSI Mode in FH50R.
- 14 FX Effects in FH50R and 11 in FH50Bi.
- Control methods: APP/remote control/on board control.
- Power supply: AC adapter/V-mount battery/NPF battery.



Flexible Handheld LED Light

FH50R / FH50Bi



FH50Bi



Light Body
Carry Bag
Adapter



x1
x1



Stand Adapter
AC Power Cord

x1
x1

FH50R



Light Body
Carry Bag
Adapter



x1
x1



Stand Adapter
AC Power Cord

x1
x1

Optional Purchase



Rectangular Softbox
FS50



Pancake Lantern
FP50



Handheld Powering
Accessory Kit ML-AK

Tech Specs

Model	FH50R	FH50Bi
Adapter Output Voltage	16.8V	
Input Power	Max. ≈62W	
NPF Battery Specifications	7.2V-8.4V ≈*2	
(available separately)		
V-mount Battery Specifications	14.8V≈	
(available separately)		
Color Temperature	2500K-10000K	2800K-6500K
Brightness Range	0%-100%	
FX Type	14	11
CRI	Average≥96	Average≥97
TLCI	Average≥96	Average≥97
Channel	32(1-32)	
Group	16(A-F, 0-9)	
ID	99: 1-99	
Mode	CCT/HSI/FX	CCT/FX
Controlling Method	2.4G Wireless Control/Bluetooth APP/ Light Body Control	
2.4G Wireless Control Distance	Max.50m	
Bluetooth Transmission Distance	Max.30m	
Working Environment Temperature	-10°C-40°C	
Dimension	317*311*34mm	
Net Weight≈	633g	570g

Flexible Handheld LED Light

FH50R / FH50Bi



Foldable LED Mat

FL60 / FL100 / FL150S / FL150R



FL150R



FL150S

FL100

FL60

Use in combination



Color Temperature 3300K-5600K

Brightness (10%-100%)

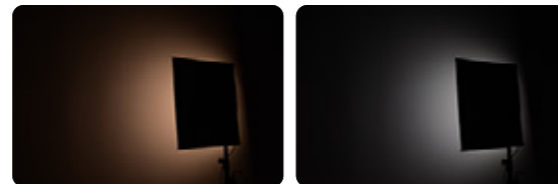

Godox FL Series Flexible LED Lights are lightweight, portable, flexible and pliable as pieces of cloth to shape what you want.

Key Features

- Soft and even light effects & adjustable light brightness and color temperature.
- Compact and portable body with strong power. Suitable for lighting in small and narrow space.
- Can be folded to different shapes and used together to achieve creative light effects.
- Achieving wireless control by 433MHz grouping system (6 groups & 16 channels) with optional remote control and smartphone APP through Bluetooth.
- Powered by Lithium battery or DC power supply.
- With easy operation, great portability and compatibility.

Foldable LED Mat

FL60 / FL100 / FL150S / FL150R

Work with the accessories to achieve a softer lighting effect.



Easy to shape what you want

Providing a light source for all kinds of videorecording or photography in a narrow space!

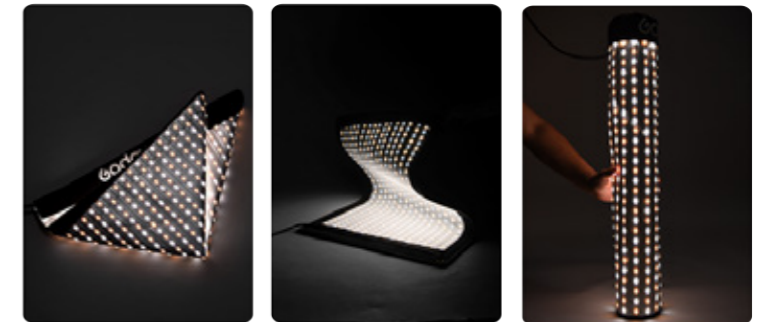

Tech Specs

Flexible LED Light	FL150S / FL150R	FL100	FL100
Power Supply	AC100V-240V(50/60Hz)		
DC Power Supply	3.5A(DC16.8V,10A)	3A(DC16.8V,7A)	2.5A(DC16.8V,4.2A)
Lithium Battery	V-port battery		
Power	150W	100W	60W
Color Temperature	3300±200K / 5600±200K		
100% Light			
Brightness (LUX)	<4300 Lux	<3300 Lux	<1800 Lux
(darkroom, 1m)			
TLCI	≥98		
CRI	>96		
Light Brightness Range	10%-100%		
Operation Temperature	-10°C~45°C		
Channel	16		
Group	6 group (A,B,C, D,E,F)		
Wireless Remote	<30m		
Control Distance			
Bluetooth Distance	<50m		
Dimension	60*60cm	30*120cm	40*60cm 30*45cm
Net Weight (only the main light body)	3.9kg	4.37kg	3.47kg 2.87kg

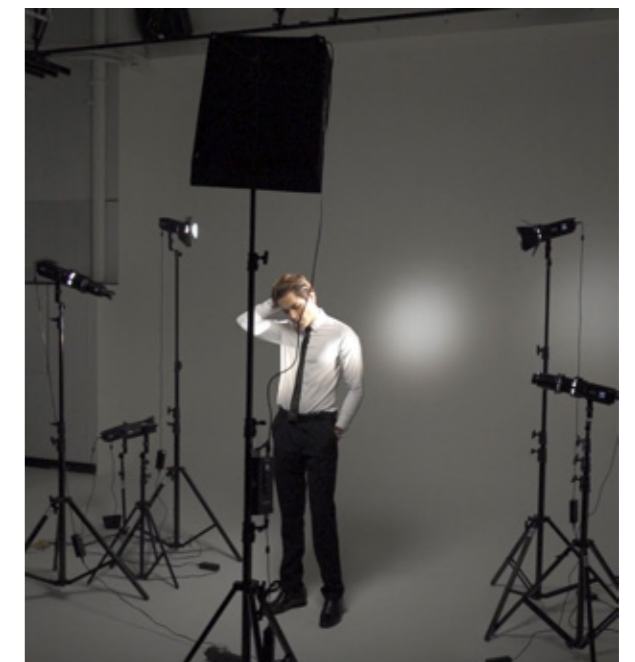



FV150

FV200

Flash Mode



The brightness of flash is four times of LED's



Over 10 continuous flashes per second in 1/2 power



1/8000s HSS



Godox wireless X system

LED Mode



Soft light effects



0-100% Precise brightness adjustment



8 FX special effects

High Speed Sync Flash and Continuous Light FV series add flash functions based on the traditional LED light. FV series can be served as a flash, as well as an LED light. With strong power, abundant functions and 8 FX special effects modes, it can achieve creative shooting easily. It fits for all kinds of shooting occasions, especially for children shooting due to its soft LED light source and strong power flash.

Key Features

As a Flash

- The flash's light brightness is four times of LED light's, which increase the freezing ability of instantaneous action.
- Supports 1/8000s high-speed sync function. Over 10 continuous flashes per second and 8 continuous flashes per second in high-speed sync mode in 1/2 power output.
- Built-in Godox 2.4G wireless receiver (X system), compatible with Canon, Nikon, Sony, Fuji, Panasonic, Olympus and Pentax cameras.
- 1/16-1/1 or 6.0-10.0 power output displayed in the form of fractions or decimal.
- Adjust modeling lamp's light brightness from 5% to 100%.

As a LED Light

- With soft light effects and high light brightness which can be precisely adjusted from 0% to 100%.
- With 8 FX special effects mode to simulate various of shooting scene and achieve creative shooting.

More Design Details

- Support wireless control (16 groups and 32 channels) with optional remote control.
- With U-type bracket to adjust different angles easily.
- Bowens-mount enables to install various of accessories conveniently.
- Large and clear LCD display.
- Excellent heat dissipation.

Hybrid Flash LED Lights



Built-in Godox 2.4G wireless receiver (X system), compatible with Canon, Nikon, Sony, Fuji, Panasonic, Olympus and Pentax cameras.



Light Effect Contrast in LED Mode(100%) and Flash Mode(1/1): (ISO:400 Aperture:F8)



Tech Specs

High Speed Sync Flash LED Light	FV150	FV200
Power Supply	100~240V(50/60Hz)	
Power	150W	200W
Color Temperature	5600±200K	
100% Light Brightness (LUX, 1M)	≈12000	≈18000
CRI(=)	96	
TLCI(=)	96	
Light Brightness Range of LED Mode	0%-100%	
Operation Temperature	-10°~45°C	
Power Output	1/16-1/1 or 6.0-10.0	
Channel	32	
Group	16(A,B,C,D,E,F,0-9)	
Dimension (not included a standard reflector)	34x20*16cm	36.7x20*16cm
Net Weight	3.13Kg	3.33Kg



LF308 Bi



LF308 D

Flash Mode

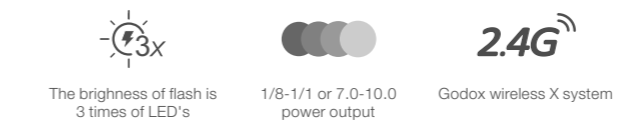

LED Mode



Featured with wireless group control and brightness adjustment with high lighting, LF308 fits various professional shooting occasions: wedding, journalistic and object video photography.

Key Features

- As a flash**
- The light is 3 times brighter when used as flash than when used as a led light.
 - 1/8-1/1 or 7.0-10.0 power output displayed in the form of fractions or decimal.
 - The modeling lamp's light brightness can be adjusted from 0% to 100%.
- As a LED light**
- 308 beads offers high brightness and stable light source.
 - 0%-100% precise brightness adjustment.
 - For the daylight version, the color temperature is fixed at 5600K. For the bicolor version, the color temperature is adjustable between 3300K and 5600K.

Tech Specs

LED Flash Light	LF308D Daylight Version	LF308Bi Bicolor Version
Lithium Battery	7.4V Lithium Battery (SONY NP-F970 model lithium battery) (sold separately)	
DC Power Supply	6.5~12V 4A	
Channel	32	
Group	6 groups(A, B, C, D, E, F)	
Power	Max. 18W	
Color Temperature	5600K±300K	3300K-5600K ±300K
Brightness (LUX)	LUX≤1300 (1 m)	LUX≤1200 (1 m)
Light Brightness Range	10%-100%	
Power Output Control	OF, 7.0-10(1/8-1/1)	
Triggering Method	Sync cord, test button, 2.4G wireless, Bluetooth	
LED Beads	308	308 (5600K:154; 3300K:154)
Quantity	3300K:154)	
Operation Temperature	-10~50 °C	
Dimension	180mm*185mm*40mm (not with the Handle)	
Net Weight	400g	

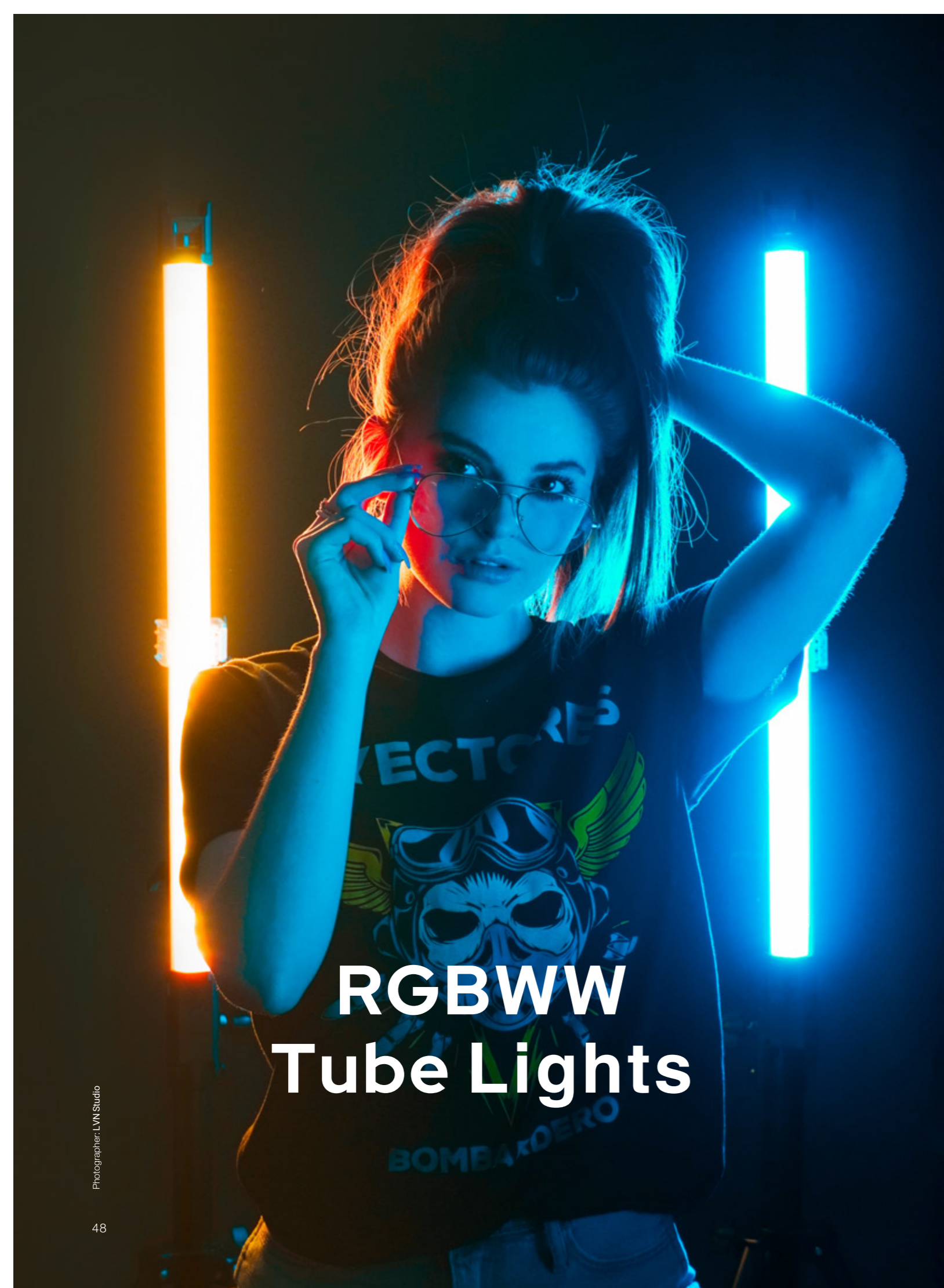

RGBWW Tube Lights

RGBWW Tube Light

TL30

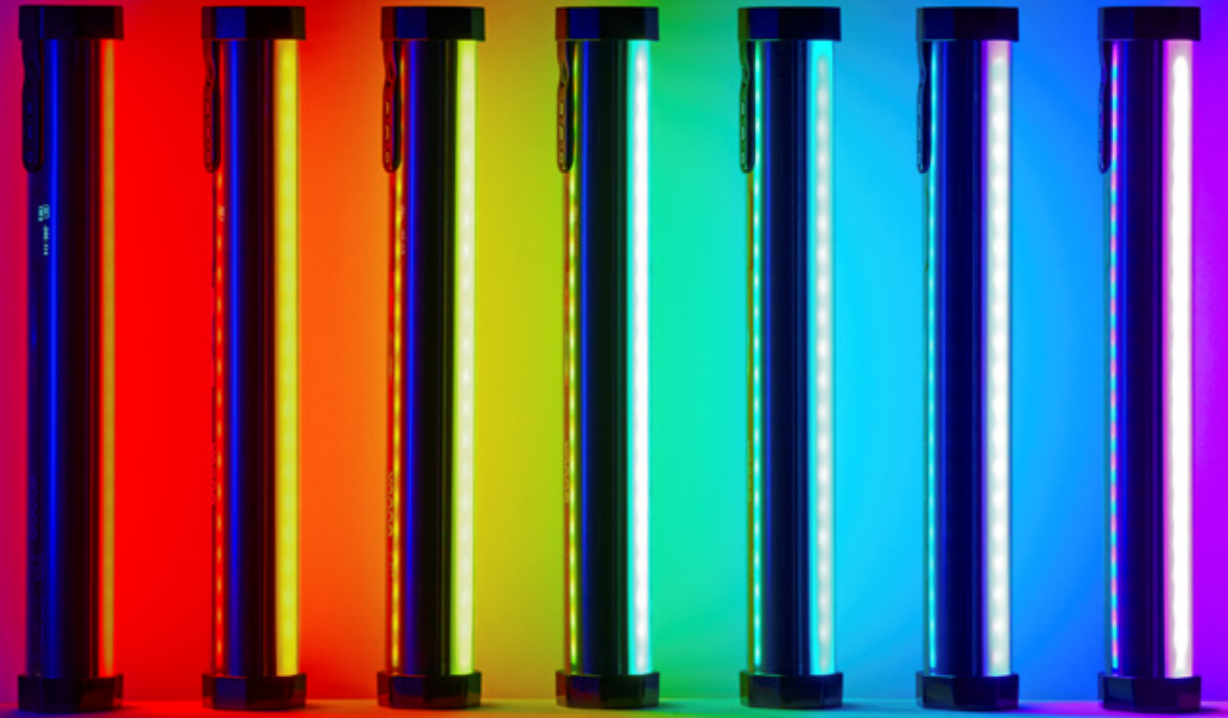

A new addition to Godox tube light family, TL30. Featuring tube shape in light weight, it is portable and easy to use. Small as it is, great potentials to expect. Tons of colors in control for dynamic content creating. Accessories like various couplers, waterproof bag, grid inspire extensive possibilities for the form, effect and even applicable environment of this light. You will enjoy the infinity that TL30 could be to enrich every shot.

Key Features

- RGBWW, CCT, HSI modes
- 36,000 Colors
- 13 Tunable effects
- Advanced Green/Magenta adjustment
- Bluetooth control with Godox Light App
- USB-C charging port
- Integrated lithium-ion battery, 3.6V/2900mAh/10.7Wh
- Embedded magnetic mounts

Abundant functions for various scenarios

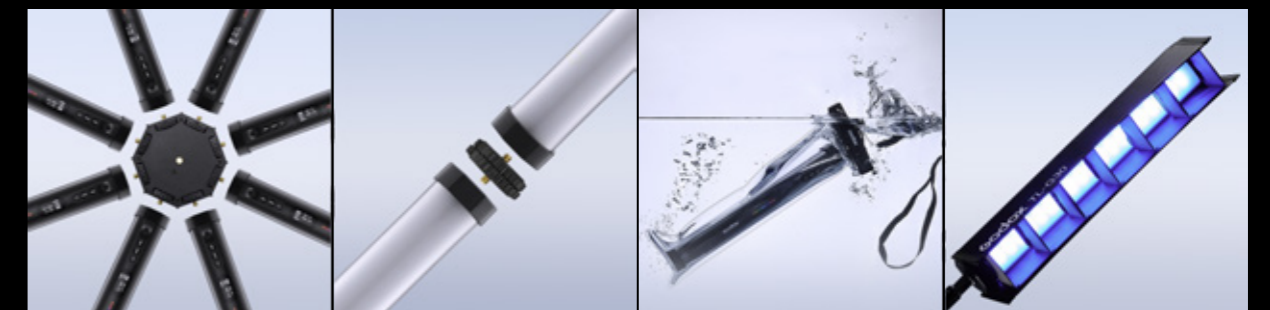

TL-M8 8-light coupler

TL-M2 2-light coupler

TL-W30 Waterproof bag

TL-G30 Grid

RGBWW Tube Light

TL60



RGBWW

Adding additional two LED whites



HSI

Fully control for up to 36000 colors



Gel

40 built-in R-Gel and L-Gel filters



CCT

Wide color temperature from 2700K-6500K



FX

39 FX effects

Godox Tube light TL60 it's designed to give users the freedom to inspire their creativity for endless range of shooting scenarios, like film making, video and photography in anywhere you go. With multiple color modes, CRI 96 and TLCI 98, ultra smart control system, and flexible tube design, TL 60 enables variety lighting setups to represent impressive performance on highly explore creativity, carry out high efficiency shooting and produce memorable magic moments.

Key Features

- Color: 2700-6500K, CRI/TLCI: 96/98
- RGBWW/ HSI Control, 40 Built-In Filters
- Battery Has 2-Hour Runtime
- Phone, DMX, 2.4 GHz Wireless Control
- Dims 0-100%, 98-164' Wireless Range
- 32 Channels, 6 Groups
- Power Adapter, DC Cable, Carry Bag



Remote



Godox Light



On-board Control



DMX

RGBWW Tube Light

TL30/TL60



No matter you want to put it into different figures, hang on the wall, hold by hand or any other creative usage. It will satisfy with any kinds of shooting scenarios in anywhere. With Godox Light APP, you can freely control multi lights wirelessly.

Tech Specs

LED Light	TL60	TL30
Internal Lithium Battery	14.4V/2600mAh	3.6V/2900mAh/10.7Wh
Adapter	Output 20V 2.4A	5V/2A(optional)
Power	Max.18W	Max.8W
Color Temperature	2700K-6500K	2700K-6500K
Light Brightness Range	0%-100%	0%-100%
RGB Color Gamut	0-360°	0-360°
100% Brightness(LUX)≈	1500	740
CRI(≈)	96	97
TLCI(≈)	98	99
Duration(continuous output in 100% full power in 2700K for 6500K)	Approx 2 hours	Approx. 60 minutes
Control Method	Smartphone APP(for both Android and IOS system)/2.4G wireless/ DMX control	Smartphone APP /
Control Distance	Bluetooth Wireless=30m 2.4G Wireless=50(with optional RC-R9 remote control)	Bluetooth Wireless ≈ 30m /
Operating Temperature	-10 to 40°C	-10 to 40°C
Dimension	φ48*750mm	φ42*300mm
Net Weight	0.73kg	0.3kg

RGBWW Tube Light

TL30/TL60

TL30-K2 Two Light Kit for TL30

- Tube Light TL30 x2
- Wrist Strap x2
- Metal Plates x6
- TL-G30 Grid x2
- USB-C Power Cable x2
- TL-C2 Retaining Clip x2
- TL-M2 2-light Coupler x1
- Adhesive Hook & Loop x6
- TL-W30 Waterproof Bag x2
- CB23 Carry Case x1



TL30-K4 Four Light Kit for TL30

- Tube Light TL30 x4
- Wrist Strap x4
- TL-G30 Grid x2
- Metal Plates x12
- USB-C Power Cable x4
- TL-C2 Retaining Clip x4
- TL-M2 2-light coupler x4
- TL-M8 8-light coupler x1
- TL-W30 Waterproof Bag x2
- Adhesive Hook & Loop x12
- CB22 Carry Case x1



TL60-K2 Four Light Kit for TL60

- Tube Light TL60 x2
- Retaining Clip x2
- Power Adapter x2
- Remote (RC-R9) x1
- DC Power Cable x2
- RJ45 Cable x2
- Wirerope x4
- Fixed base x2
- Toggle clip x2
- CB39 Carrying Bag x1



TL60-K4 Four Light Kit for TL60

- Tube Light TL60 x4
- Retaining Clip x4
- Power Adapter x4
- Remote (RC-R9) x1
- DC Power Cable x4
- RJ45 Cable x4
- Wirerope x8
- Fixed base x4
- Toggle clip x4
- CB40 Carrying Bag x1



RGBWW Tube Light

TL120



Struggle with a shot that fails to display your imagination, or desire for more power to ignite the viewers? You can always find better answers on lights. TL120 gives freedom shaping the visual impacts in any forms, try these stylish tube-shaped lights to draw the scene you want! They can be everywhere, in any forms! To throw some as glaring background practicals, to sketch beautiful rims by single set, or even create powerful arrays by stacking tubes, you may spend a day investigating the limitless ways of how they show up.

Key Features

- 117cm long, light wider with more power
- Simple elegant tube shape makes them perfect for structuring spatial depth on screen
- Full feature settings on RGB, HIS, OCT, Gel and FX, by one tap on the App you create exciting collision of colors, adding rich dynamics and visual power to build your scene to a rousing climax
- TL120 can be easily controlled on Godox Light App, RC-R9 remote, or DMX controller
- Clear reading screen and easy on-board function setting, TL120 ensures a smooth usage as well as speedy adjusting
- Inbuilt battery lasts more than 150 minutes even at full power output

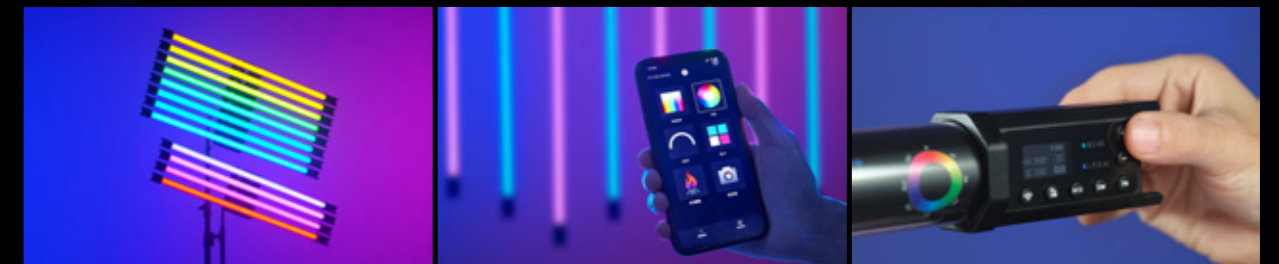

RGBWW Tube Light

TL120

Tech Specs

LED Light	TL120
Built-in Lithium Battery	14.4V/5200mAh/74.88Wh
Adapter	20V/4.8A
Output Power	30W
Channel	32
Group	6 (A B C D E F)
Color Temperature Range	2700K-6500K
Light Brightness Range	0%~100%
RGB Color Gamut	0 ~ 360°
CRI (≈)	96
TLCI (≈)	98
Duration(continuous output in 100% full power in 2700K or 6500K)	150 minutes
Control Method	Smartphone APP/2.4G wireless/DMX control
Bluetooth Wireless Control Distance	≈30m
2.4G Wireless Control Distance	≈50m (with optional RC-R9 remote control)
Operation Temperature	-10~40 °C
Dimension	48*1170MM
Net Weight	1.27kg

CCT	Illumination Unit	1m	2m	3m
2800K	lux	659	202	101
	fc	61.2	18.8	9.4
3200K	lux	610	187	93.3
	fc	56.7	17.4	8.7
4300K	lux	666	205	102
	fc	61.9	19	9.5
5600K	lux	685	210	104
	fc	63.7	19.5	9.7
6500K	lux	769	234	117
	fc	71.3	21.7	10.9



Optional Purchase



Grid TL-G120 Adapter Holder LSA-18 2-light Bracket TL-B2 4-light Bracket TL-B4 8-light Bracket TL-B8

- TL120-K4**
- Light Body x4
 - 5m Power Cord x4
 - Adapter x4
 - RJ45 Cable x4
 - Clip x8
 - Steel Cable x8
 - Adapter Holder x4
 - Remote control RC-R9 x1
 - Carry Bag CB47 x1



RGBWW Tube Light

TL180



Low-profile, self-contained and portable, TL180 is a 180cm full RGBWW tube light designed to benefit filmmakers, content creators, videographers and photographers. As the latest member of Godox tube light TL series, it's longer, more powerful and with a larger light-emitting area, giving more liberty to your creation.

Key Features

- 180cm in length, more powerful with a larger light-emitting area
- Adjustable hue, saturation, intensity
- 40 preset color gels
- CRI=96 TLCI=98
- Color temperature ranging from 2700K to 6500K
- 14 kinds of preset light effects and each involves 2-3 modes
- Easily controlled by Godox Light App, RC-R9 remote, or DMX controller
- Powered by AC adapter or built-in lithium battery
- Up to 160-minute runtime with 100% brightness on a full charge



Optional Purchase



Two-light Bracket Kit
TL180-B2



Four-light Bracket Kit
TL180-B4



Grid for TL180
TL-G180

Tech Specs

LED Light	TL180
Built-in Lithium Battery	14.4V/9000mAh/129.6Wh
Adapter	20V/5.5A
Power	Max.55W
Duration(continuous output in 100% full power)≈	160 minutes
Channel	32
Group	6 (A B C D E F)
Color Temperature Range	2700K-6500K
Light Brightness Range	0%~100%
RGB Color Gamut	0 ~ 360°
CRI (≈)	96
TLCI (≈)	98
Control Method	Smartphone APP/2.4G wireless/ DMX control
Bluetooth Wireless Control Distance	≈30m
2.4G Wireless Control Distance	≈50m (with optional RC-R9 remote control)
Operation Temperature	-10~40 °C
Dimension	51*1800mm
Net Weight	2.21kg

Illuminance Data

CCT	Illumination Unit	1m	2m	3m
2700K	lux	776	253	145
	fc	72.1	23.5	13.5
3200K	lux	672	234	125
	fc	92.7	21.8	11.6
4300K	lux	687	240	128
	fc	63.8	22.3	11.9
5600K	lux	729	254	136
	fc	67.8	23.6	12.6
6500K	lux	895	312	167
	fc	83.2	29	15.5













ZHUOYA
PHOTOGRAPHY

Photographer: ZhuoYa

Light Sticks



- 
1580Lux@5600k@1m
- 
CRI 95+
CRI 95+
- 
CRI 96+
TLCI 96+
- 
Compact Design
- 
Replaceable Battery Handle
- 
Barndoor
- 
2500K-8500K
- 
Multiple Color Modes
- 
11FX/15FX Effects
- 
Godox Light App

Featuring a replaceable battery handle, the LC500mini/LC500Rmini excels in outdoor shooting endurance. Compact at 1.5 feet and about 1.2 pounds, it's highly portable. The optical lens design enables 1580 lux at 20 watts. Discover a new level of portable brilliance with the LC500mini/LC500Rmini.

Key Features

- Battery Grip Convenience
- Compact at 1.5 feet and about 1.2 pounds
- 1580 Lux from 20W
- 2,500K-8,500K Color Temperature
- Shape Light with Barndoor
- 11 built-in FX effects
- APP Control

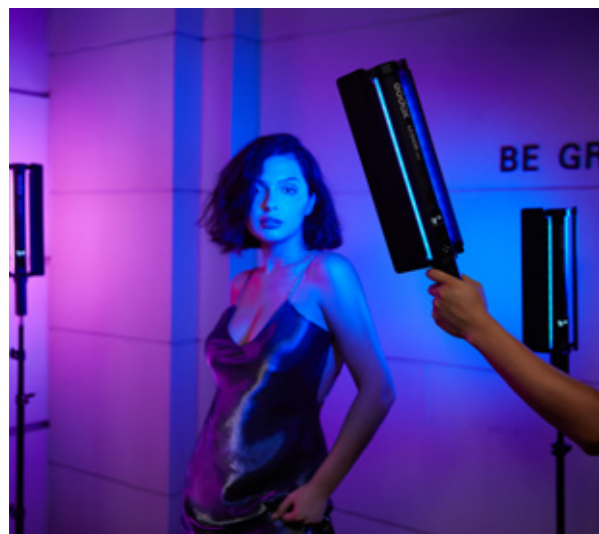

Optional Purchase



LC-D01
Diffuser for LC500 mini
& LC500R mini



BG01
Grip Handle
(with Built-in Battery)



BG01
Grip Handle
(with Built-in Battery)

Tech Specs

Model	LC500 mini	LC500R mini
Built-in Lithium Battery	7.2V≈2470mAh	
Battery Life (at 100% brightness, 5600K)	Longest battery life ≈45 min	Longest battery life ≈50 min
Type-C Input	5V≈2A 9V≈2A 12V≈2A	
Charging time	≈1 hour 25 minutes(12V≈2A)	
Input Power	Max. ≈20W	
CCT	2500-8500K	
Brightness Range	0% - 100%	
FX Type	11	15
CRI	Average≥95	
TLCI	Average≥96	
Control Method	Bluetooth Control/Light Body Control	
Bluetooth Control Distance	Max. 30m	
Working Environment Temperature	-10°C ~ +40°C	
Dimension (Including Grip Handle)	1.69"x1.73"x18"	
Net Weight≈	548g	559g





With cold/warm color temperature and adjustable light brightness, LED Light Stick LC500 is suitable for various of occasions like live, self portrait, product and wedding shooting, camping, etc. Added with RGB mode and FX light effect, LC500R adopts all you loved about its predecessor to further free your creativity. Its two-way barndoor shapes and directs the light spread. With the CRI rating at 96 and TLCI at 98, the light reproduces the nature and vibrant colors.





LC500R

Key Features for LC500R

- Freely switch LED bicolor mode, colorful light mode and 39 situational special effects modes
- Easy to adjust color temperature, light brightness, hue and color saturation
- Wireless remote control (optional) offers great convenience
- With easy operation and wide application

 RGB /CCT Mode
  Max. 23W
  96
  98



 5800
  Wireless Remote Control
  0-100% Precise brightness adjustment



Key Features for LC500



- With high color rendering index(CRI>95, TLCI≥95) and even illumination to present the objects authentically.
- Freely choose cold or warm color temperature. And the light brightness can be adjusted from 10% to 100%.
- Built-in lithium battery with long-lasting power supply.
- Optional remote control to wirelessly(6 groups & 16 channels) adjust the light for convenient shooting.
- Lightweight, portable and widely applicable.



LC500

 3300K
  5600K

 With built-in lithium battery and it's easy to charge
  Clear LCD panel and easy operation

 Wireless remote control (Optional)
  Comes with a carrying bag for easy transport and carriage



Tech Specs

LED Light	LC500	LC500R
Built-in Lithium Battery	14.8V/2600mAh	14.4V/2600mAh
Power	Max.18W	Max.23W
Color Temperature	3300K±300K / 6500K±300K	2500K-8500K
Channel	16	32
Group	6(A, B, C, D, E, F)	6(A, B, C, D, E, F)
Light Brightness Range	0%~100%	10%~100%
RGB Color Gamut	N/A	0~360°
100% Brightness(LUX)≈	1200 (1m)	Max. 5800
CRI(≈)	≥95	96
TLCI(≈)	>95	98
Duration (continuous output in 100% full power)	N/A	Approx. 90 minutes
Operating Temperature	-10 to 45°C	-10 to 45°C
Dimension	565*56*56mm	616*56*56mm (reflector is not included)
Net Weight	760g	0.81kg

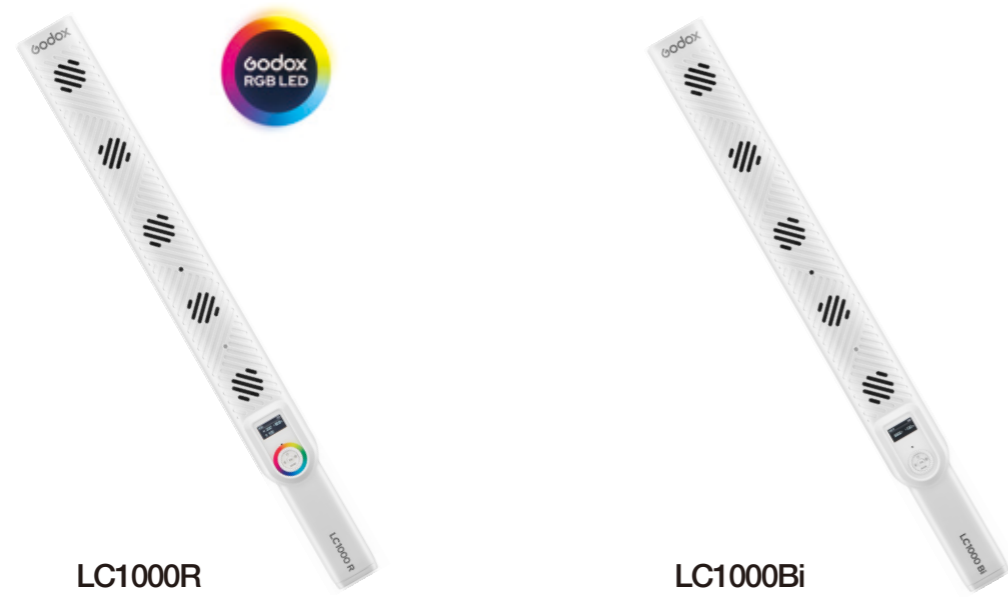

LC1000R

LC1000Bi

POWER
100_w

100W Output



Multiple
Color Modes



Grip Comfort



Versatile
Power Options

LC1000Bi/LC1000R LED Light Stick – with powerful illumination, delivering impressive brightness at 100W in P mode. Ignite creativity with dynamic RGB colors and enjoy smooth, professional-quality lighting for various settings. Effortless handling ensures ease of use, while versatile power options keep you charged. Transform scenes with 11/15 built-in FX effects, perfectly synchronized with music.

Key Features

- Powerful Lighting Output
- Dazzling Creations with Dynamic RGB Colors
- Smooth & Pro-Quality Illumination
- Designed for Effortless Handling
- Long Battery Life (Normal mode:Max.≈59min, P mode:Max.≈28min)
- Multiple Charging Options
- 11/15 built-in FX effects
- 2500K-8500K
- Easily Controlled via Device or App
- TLCI 96+ and CRI 96+

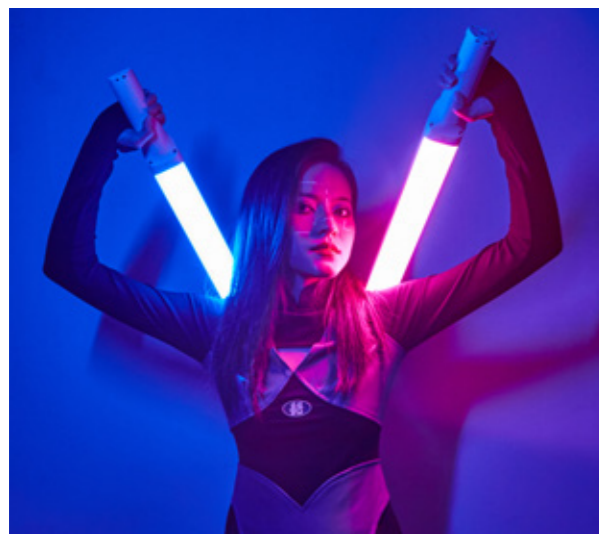

Optional Purchase



Grid

Tech Specs

Model	LC1000R	LC1000Bi
Built-in Lithium Battery	21.6V/2600mAh 56.16Wh	
Battery Life(at 100% brightness, 5600K)	Normal mode:Max.≈59 min, P mode:Max.≈28min	Normal mode:Max.≈49 min, P mode:Max.≈27 min
Type-C Input	5V/9V/12V/15V/20V100W(Max.)	
DC Input	20V≈6A	
Input Power	Normal Mode:Max.≈65W, P mode:Max.≈100W	
CCT	2500-8500K	
Brightness Range	0%~100%	
FX Type	15	11
CRI	Average≥96	
TLCI	Average≥96	
Control Method	Bluetooth Control/Light Body Control	
Bluetooth Control	Max. 30m	
Distance		
Working Environment	-10°C ~ +40°C	
Temperature		
Dimension	2.2"x21.97"x1.89"	
(Including Grip Handle)		
Net Weight≈	1kg	

Dive Lights

WT25D/WT40D/WT60D
WT25R/WT40R/WT60R (RGBWW)



Dive Lights

WT25D/WT40D/WT60D
WT25R/WT40R/WT60R (RGBWW)



WT25D WT25R

WT40D WT40R

WT60D WT60R

The diving lights bring a completely new way to light up underwater, even at 40m. Rarely found in traditional dive lights, they are tube-like in shape easily to be adjusted for different lighting angles for your desired effects. The unique shape makes it feasible to illuminate a wider area, discovering more wonders beneath the sea. The light it produces is remarkably smooth, adding a dreamlike atmosphere when applied to underwater portraits.

Key Features

- Offer exceptional water resistance and can perform at a professional level even when submerged up to 40m.
- Switch to high power automatically when submerged, offering more brightness.
- Equipped with a fluorescent button for easy on/off, mode changes, color adjustments, and other actions.
- The tube design creates a diffused and evenly distributed light.
- Standby time of up to 2 hours (WT60R/WT60D) at their maximum brightness in underwater mode.

Dive Lights

WT25D/WT40D/WT60D
WT25R/WT40R/WT60R (RGBWW)



Optional Purchase



Light clamp WT-C01

Tech Specs

Model	WT25D	WT40D	WT60D
Power supply	5V/2.5A, 9V/1.5A, 12V/1A, 15V/0.8A, 20V/0.75A	5V/3A, 9V/3A, 12V/3A, 15V/2.7A, 20V/2A	20V/3.25A
Power underwater	Max. 24W	Max. 54W	Max. 70w
Power abovewater	Max. 10w	Max. 13w	Max. 21W
Charging port	Type-C	Type-C	DC input port
CCT	5600K±300K	5600K±300K	5600K±300K
TLCI	≥96	≥96	≥96
CRI	≥96	≥96	≥96
Brightness adjustment range	0%-100%	0%-100%	0%-100%
Waterproof rate	IP68 (40 meters underwater)	IP68 (40 meters underwater)	IP68 (40 meters underwater)
Charging time	2h at the soonest	2h20min at the soonest	2h40min at the soonest
Battery life (100% brightness)	≈1h (underwater) ≈2h20min (abovewater)	≈1h20min (underwater) ≈5h30min (abovewater)	≈2h (underwater) ≈6h (abovewater)
Control Method	Bluetooth APP control	Bluetooth APP control	Bluetooth APP control
Bluetooth control distance	≈25m (only abovewater)	≈25m (only abovewater)	≈25m (only abovewater)
Working environment temperature	-10°C~40°C	-10°C~40°C	-10°C~40°C
Dimension	57mm*52mm*250mm	57mm*52mm*380mm	57mm*52mm*640mm
Net weight	0.64kg	1.08kg	1.9kg

Dive Lights

WT25D/WT40D/WT60D
WT25R/WT40R/WT60R (RGBWW)

Tech Specs

Model	WT25R	WT40R	WT60R
Power supply	5V/2.5A, 9V/1.5A, 12V/1A, 15V/0.8A, 20V/0.75A	5V/3A, 9V/3A, 12V/3A, 15V/2.7A, 20V/2A	20V/3.25A
Power underwater	Max. 20W	Max. 55W	Max. 77w
Power abovewater	Max. 7w	Max. 15w	Max. 14W
Charging port	Type-C	Type-C	DC input port
CCT	1800K-10000K	1800K-10000K	1800K-10000K
TLCI	≥96	≥96	≥96
CRI	≥96	≥96	≥96
Brightness adjustment range	0%-100%	0%-100%	0%-100%
Mode	CCT Mode/HSI Mode/ RGBW Mode/GEL Mode/FX Mode	CCT Mode/HSI Mode/ RGBW Mode/GEL Mode/FX Mode	CCT Mode/HSI Mode/ RGBW Mode/GEL Mode/FX Mode
Waterproof rate	IP68 (40 meters underwater)	IP68 (40 meters underwater)	IP68 (40 meters underwater)
Charging time	2h10min at the soonest	2h20min at the soonest	2h at the soonest
Battery life (100% brightness)	≈1h (underwater) ≈3h (abovewater)	≈1.5h (underwater) ≈5.8h (abovewater)	≈2h (underwater) ≈10h (abovewater)
Control Method	Bluetooth APP control	Bluetooth APP control	Bluetooth APP control
Bluetooth control distance	≈25m (only abovewater)	≈25m (only abovewater)	≈25m (only abovewater)
Working environment temperature	-10°C~40°C	-10°C~40°C	-10°C~40°C
Dimension	57mm*53mm*250mm	57mm*53mm*380mm	57mm*53mm*640mm
Net weight	0.66kg	1.1kg	1.9kg



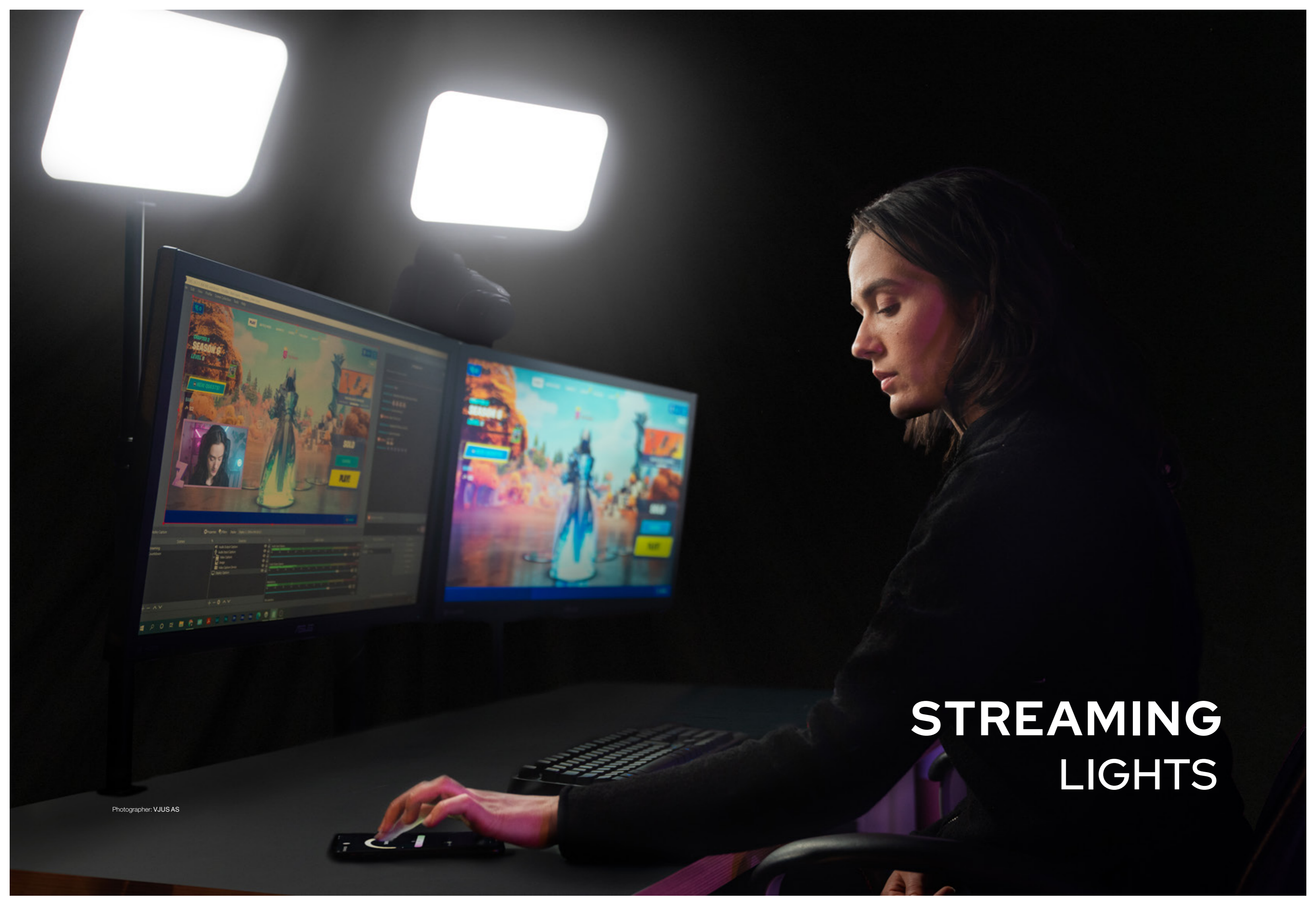

STREAMING LIGHTS

Photographer: VJUS AS



Want to get started in e-sports streaming but don't know how to look professional to the audience? Find your answer on ES30. Portable and affordable with super soft illumination, it reduces the harsh shadow on your face and creates a glowing look, making your channel stand out from the mundane mass of others.

Key Features

- Ultra-soft lighting with edge-lit technology
- Gentle on the eyes
- Brightness stepless adjustment from 0-100%
- Color temperature adjustable from 2800k-6500k
- No fan, no fan noises, good for streaming
- Godox Light APP control available
- Slim body suitable for narrow space
- Selectable between desktop stand and desk-mount clamp

Tech Specs

Model	Es30
Adapter Input	100-240V~50/60Hz 1.0A
Adapter Output	14V=2.5A
Power	Max.35W
CCT	2800-6500K
CRI	96+
TLCI	97+
Brightness Range	0~100%
Control Method	Light body control/Bluetooth control
Working Temperature	-10°C-40°C
Dimension	233*233*42mm
Net weight≈	0.74kg

ES30 Kit 1

- Light Body ×1
- Adapter ×1
- Power Cable ×1
- Telescopic Desk Mount Stand ×1



ES30 Kit 2

- Light Body ×1
- Adapter ×1
- Power Cable ×1
- Telescopic Desktop Stand ×1



Illuminance Data

ES30		Illuminance unit		
CCT		0.5m	1m	2m
2800K	lux	1190	315	87.1
	fc	111	29.3	8
3200K	lux	1510	399	110
	fc	140	37.1	10.2
4300K	lux	2280	602	167
	fc	212	56	15.5
5600K	lux	1550	408	113
	fc	144	37.9	10.5
6500K	lux	1330	350	96.9
	fc	123	32.5	9

All the above tests are based on the condition of 100% brightness

E-sports LED Light



Designed especially for E-sports streamers, ES45 Kit is built to last with solid metal while keeping incredible slim and space-saving. It is bright enough to illuminate your streaming space yet still comfortably soft to your eyes. Embrace the ES45 Kit and just WOW. You look much more professional than before.

Key Features

- Magnetic Auto-Charging Remote Controller
- Adjust color and brightness with the wireless 2.4 GHz controller. It's detachable from the light and reattaches magnetically to charge.
- iOS/ Android Smartphone Control: Godox Light app
- The ES45 renders soft light that is especially flattering to skin tones and complexions, so you'll always look your best.

Group Control at Your Fingertips

Find out the perfect lighting setup without even getting up! Download the Godox Light app to your smartphone or tablet (iOS/Android), then you can control multiple lights at the same time at your fingertip via Bluetooth.

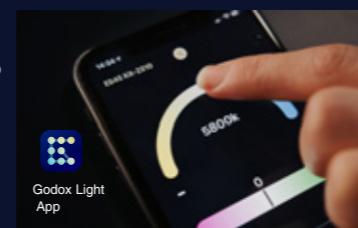

Magnetic Auto-charging Controller

Adopting 2.4G technology, the detachable magnetic controller can adjust the brightness and the color temperature for a precise lighting set-up in real-time. Once the streaming is closed, you can put it back to the light panel for auto-charging.



Photographer: VJUS AS

E-sports LED Light

ES45 Kit

Cool in the E-Sport

Featuring a super-efficient cooling system, ES45 Kit keeps the heat impressively low. You can enjoy long-hour streaming with a comfortable and neat ambience.



Spotlight You from Anywhere

Low profile, thin, simple and elegant design. Effortless installation for a quick setup. Free rotation to desired angles for the best light effect.

Tech Specs

Model	ES45 Kit
DC Power Supply by Adapter	Input: 100~240V 50/60Hz 1.3A Output: 14.8V 3.42A
Lithium Battery of Operate Panel	3.7V Lithium battery (built-in)
Power	Up to approx. 47.6W in max. (color temperature: 4100K)
Channel	32 (1~32)
Group	3(A, B, C)
Color Temperature	2800 ~ 6500K
100% Lumen (lm)	Max. 2500
100% Luminosity (lx)	Max. ~4100 (darkroom, 0.5m distance)
CRI	≥96
TLCI	≥97
Brightness Range	0~100%
Control Method	Smartphone APP/2.4G Wireless
Quantity of LED Beads	176
Working Environment Temperature	-10~40°C
Dimension	367 * 230 * 31.04mm (operate panel is not included) 367 * 230 * 45.9mm (operate panel is included)
Weight	1.33KG (operate panel is included)

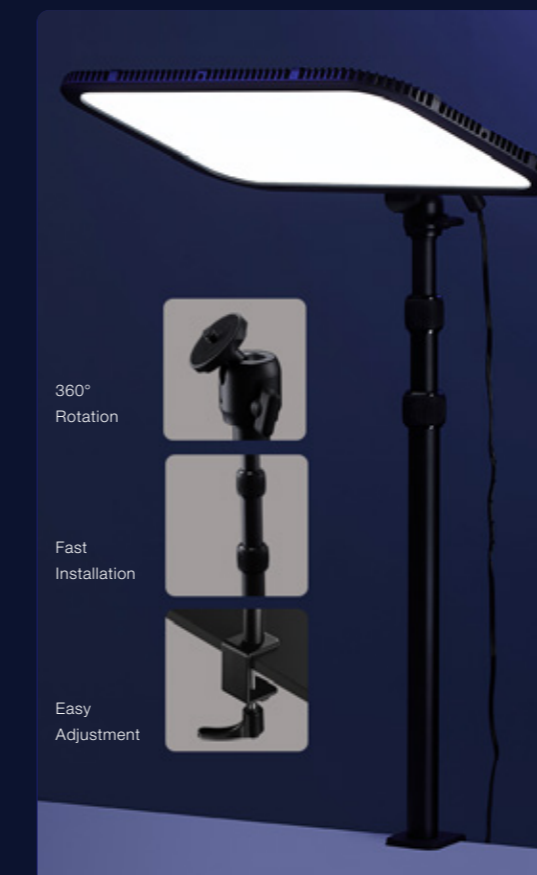

LED Ring Light

LR120/LR150



LR120

LR150

LED Ring Light LR120/LR150 is suitable for wide occasions e.g. livestream, video, make up, product shooting, etc.

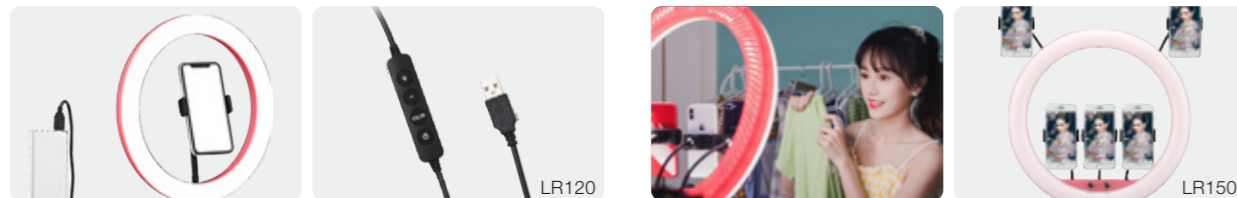

Key Features

- Freely adjust color temperature and brightness
- Soft light effects and catchlight
- Easy operation
- Flexible application



Tech Specs

LED Ring Light	LR120	LR150
DC Power Supply	5V/2A	24V/2A
USB Power Output	/	5V/2A
Power	Approx. 10W	Approx. 38W
Color Temperature	3000K-6000K	3000K-6000K
100% Brightness(LUX) 0.5m [≈]	550	1400
Light Brightness Range	0%~100%	1%~100%
CRI	> 90	> 90
TLCI	> 90	> 90
LED Beads Quantity	222	336
Operation Temperature	-10~40°C	-10~40°C
Dimension	305x395x35mm	455x555x45mm
Weight	Black version: 440g	Black version: 880g Warning Pink version: 870g

LED Ring Light

LR160/LR180



LR160

LR180

With cold or warm temperature and light brightness adjustment, LED Ring Light LR160 & LR180 is suitable for live, portrait shooting and make up. There are pink version and black version for choice.

Key Features

- Premium LED beads with soft light effects.
- Adjustable light brightness and color temperature.
- DC power supply or lithium batteries (separately sold). Note: LR160 supports DC & lithium batteries power supply while LR180 only supports DC power supply.
- Included a smartphone holder to offer convenience.



Adjust LR160's color temperature by rotating the knob.



Adjust LR180's color temperature by replacing different light-passing board.

Light brightness adjustment

Tech Specs

LED Ring Light	LR160	LR180
Lithium Battery	2*7.4V Lithium battery / (NP-F970)(separately sold)	/
DC Power Supply	16V/1.5A	16.8V/2A
Power	Approx. 18W	Approx. 27W
Color	3300K-8000K	Black version: 3300K or 5600K
Temperature		Pink version: 3100K or 5000K
100% Brightness (LUX) (1M)	Below 400 (1 meter)	Black version: White light-passing board 600 Yellow light-passing board 400 Pink version: White light-passing board 600 Yellow light-passing board 500
CRI (max. brightness)	≈92	≈92
TLCI (max. brightness)	≈97	≈97
Light Brightness Range	10% ~ 100%	Light brightness can be adjusted.
Range		
LED Beads	160	180
Quantity		
Operation Temperature	-10°C ~ 40°C	-10°C ~ 40°C
Dimension	49.2*59*4 cm	36.1*46*4cm
Weight	1.21Kg	0.88kg (with one light-passing board)



As an influencer, you may always have a headache on how to decorate your studio with a limited budget, and how to create a viewer-welcoming atmosphere for your channel. CL10, multi-color LED Webcasting Ambient Light is specially designed to meet your needs. With 36,000 selectable colors and 39 special effects, it enables your studio to be fully decorated with customized lighting colors, delivering picturesque live streaming for your audience, assisting your career on webcasting with comparative ease and moving forward to the upper stage.



Free Color Adjustment



Multiple Controls



Blink with Music



39 Special Effects

Key Features

- Built-in RGB and HSI color function offers 36,000 selectable colors for users to adjust flexibly based on variable needs during live streaming. It can support users to build recognizable personal style, illuminate video and attract followers and subscribers effectively.
- 39 pre-programmed effects highly mimic lighting from real scenes to match with various performance requirements and user's diverse fashion choices.
- APP and IR remote control offers a handy approach for users to quickly adjust and control all of the lighting modes right in the palm.
- Built-in multidimensional heat dispersion can protect lighting from high temperature and prolong its service time.
- To make sure of uninterrupted power supply for continuous live streaming, CL10 can be powered by an adapter and type-c charging like a power bank.

Tech Specs

Model	CL10
Power Supply	USB Power supply(5V/2A)
LED Light's Power	10W
RGB Color	0 - 360°
100% Max. Illumination(LUX)	≈1100 (green light)
Beam Angle	120°
Hue Range	0 - 360°
Saturation Range	0 - 100%
Wireless Control Modes	Wireless Remote control/ Smartphone APP
Wireless Control Distance	15m
Light Effects Modes	39
Temperature of Working Environment	-10° - 45°C
Dimension	192*192*65mm
Weight	270g



WATERPROOF LIGHTS



Waterproof Lights

WL4B



WL4B is a tiny pocket-sized LED light for creators, which is able to ignite your creation everywhere you go, to light your interview or live stream whenever you need. Waterproof function allows you to explore your journey in various environments. Bring the light with you, any challenge is possible!



Key Features

- A CRI/TLCI rating of 97 and the 55° beam angle make it a powerful light fixture with excellent color rendition
- Wireless control via Godox Light APP support easy brightness adjustments, FX settings and the other necessary controls
- The fixture supports 13 effects including Lighting, Flash, Broken Bulb, TV, and SOS
- The WL4B is waterproof down to 100ft, which allows you to comfortably use the fixture in wet weather as well as dry, or when submerged
- It incorporates a rechargeable battery that lasts 80 minutes at full brightness, conveniently charging via USB-C cable connecting with your power bank or other power supplies outdoors.



Tech Specs

Model	WL4B
Built-in Lithium Battery	3.8V/1500mAh
Power	Max. 4W
Waterproof Level	IPX8(30m)
Color Temperature Range	5600K ± 300K
Max. Illumination (LUX)(0.5m)(=)	1900
CRI(=)	97
TLCI(=)	97
Brightness Range	Low / Medium / High / SOS
Beam Angle	55°
Continuous Usage Time	High brightness = 1 hour and 20 minutes Medium brightness = 2 hours Low brightness = 5 hours and 30 minutes
Standard Charging Power Source	DC5V/2A
Control Method	Smartphone APP
Working Environment Temperature	-10~40°C
Dimension	45*45*47mm
Weight	116g

Waterproof Lights

WL8P



As a pocket-sized LED with rugged metal housing, WL8P is perfect for on-the-go shooting even in tough conditions. Featuring trustful brightness, high color fidelity and adjustable color temperature, the light combines high performance with portability, ready to cope with any wet weather shooting or realize your underwater creativity.

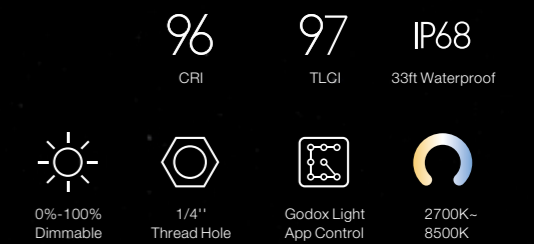

Key Features

- Born for on-the-go
Compact, portable and rugged, WL8P packs every remarkable feature for your on-the-go shooting. Measuring 11cm*5.7cm*3.25cm and weighing only 263g, taking a WL8P is almost like taking another smartphone, barely adding any burden to your journey.
- Ready for Water Challenge
With IP68 waterproof down to 10m, the light can resist wet weather and accidental splash easily, a reliable solution for any waterside vlogging and video making.
- Light up Your Creation
160 high-quality LED beads bring trustworthy brightness, dimmable from 0%-100%. Combined with a wide beam angle, it allows you to light up all the subjects within the frame. Perfect to serve as a Vlog light or fill light for your shooting.
- Excellent Color Fidelity
With a CRI rating of 96+ and a TLCI rating of 97+, it delivers vibrant, natural light and reproduces accurate colors.
- Adjustable Color Temperature
The CCT mode features a wide color temperature range from 2700K-8500K, providing more creative ways with no need for gels. A nice choice to match the ambient light, shape your look and get the amazing skin tone you want.
- Creative Light Effects
8 built-in special light effects with 3 modes each (except for strong light effect) for creating various dramatic effects, adding spice to your video content at no extra cost.
- Wireless Control at Your Fingertip
Through Godox Light App, you can change the brightness, color temperature and FX effects of WL8P remotely. Especially practical when you use it as an underwater light source or need group control.

- Power that Never Fails You
Built-in 2900mAh lithium battery guarantee a 1-hour runtime at full brightness, which helps you concentrate on creation without interruption. A reliable choice both on location and indoor.

Tech Specs

Model	WL8P
Built-in Lithium Battery	3.7V/2900mAh/10.73Wh
Standard Charging Power Source	DC 5V/2A
Power	10W
Waterproof and Dustproof Grade	IP68(10m)
Color Temperature Range	2700K-8500K
CRI(=)	96
TLCI(=)	97
Brightness Range	0%-100%
Photometrics	313 fc / 3370 Lux at 0.98' / 0.3 m 116 fc / 1250 Lux at 1.64' / 0.5 m 30 fc / 323 Lux at 3.28' / 1 m
Bluetooth Transmission Distance on Land	10m
Continuous Working Time	100% brightness: 1h
Control Method	Mobile phone APP
Working Environment Temperature	-10°C - 40°C
Dimension	11cm*5.7cm*3.25cm
Net Weight	263g

SMARTPHONE LIGHTINGS



Smartphone Lightings

R1/M1

R1



Free Color Adjustment



Blink with Music



39 Special Effects

Round RGBWW Mini Creative Light R1 can change different colors and achieve creative light effects with RGBWW mode, bicolor modes and 39 special effects modes.

Key Features

- This light can change multiple colors to achieve creative light effects. With approx. 98 CRI and 97 TLCI, it can present projects authentically.
- There're 39 different patterns in RGB scene mode, e.g. music, lightning, screen, RGB quick recycle, RGB slow recycle, candlelight, police car, fire truck, ambulance, etc.
- Built-in Lithium Battery and Charge with Type-C USB Port, Freely adjust light brightness from 0% to 100%. It supports continuous work for 1.5 hour in full power.
- Compatible with Various of Accessories and Achieve More Light Effects With magnetic accessory port, this light supports to install AK-R1 round head accessories (separately sold) and achieve creative shooting.
- With built-in magnet, this light can be quickly pasted onto the back of smartphone, which saves a lot of time and energy.

Tech Specs

Model	R1
Built-in Lithium Battery	1800mAh
Power	Max. 5W
Charging power supply	5V1A, 5V2A
Color temperature range	2500K-8500K
100% Illuminance(LUX)(0.5m)(=)	605
CRI(=)	98
TLCI(=)	97
Light brightness range	0%~100%
Duration(continuous output in 100% power)	Approx. 90 Minutes
Operation temperature	-10~45°C
Dimension	Diameter: 75mm; Thickness:23mm
Net weight	150g

M1



Free Color Adjustment



Blink with Music



40 Special Effects

With 40 special effects modes, fashion appearance, simple operation and great portability, RGBWW Mini Creative Light M1 is suitable for macro photography, video shooting, microfilm, live, portrait shooting, product shooting, etc.

Key Features

- Freely switch CCT mode, RGB mode and 40 FX special effects modes.
- Easy to adjust color temperature, light brightness, hue and color saturation
- With a dedicated screen to display parameters precisely
- With a universal accumulating bracket to quickly adjust different lighting angles
- With simple operation and light and thin body which offers great portability
- Various of using methods

Tech Specs

Model	M1
Charger(separately sold)	5V2A/18W QC3.0(5V3A,9V2A,12V1.5A)
Power	Max. 13W
Color temperature range	2500K-8500K
Light brightness range	0%~100%
RGB Color gamut	0~360°
100% Illuminance(LUX)	Max. 1700
CRI(=)	97
TLCI(=)	97
Bracket rotation angle	Main axis: 360°; Inside axis: 270°
Duration(continuous output in 100% power)	150 Minutes
Operation temperature	-10~45°C
Dimension	145*70*15mm
Net weight	240g



With the light weight and convenient operation, LEDM32 & LEDM150 Mini Light is excellent for all kinds of mobile phones.

Key Features

- High-quality LED bulbs
- Built-in lithium battery
- Soft and even illumination
- Adjustable light brightness
- With the optical control flash fire function
- With a lightweight and portable body
- Fit almost any mobile phones

Tech Specs

LED Light	LEDM32	LEDM150
Built-in Lithium Battery	3.7V 300mAh	3.7V-3000mAh
Power	Max. 1.4W	Max. 9W
Color Temperature	5200K±300K	5600K±300K
Brightness (LUX)	>120 (0.5 m)	1029 (0.5 m)
Color Rendering Index	≥95	>95
TLCI	≥94	≥94
Light Brightness Range	10%~100%	10%~100%
LED Beads Quantity	32	150
Operation Temperature	-10~50°C	-10~50°C
Dimension	50mm*50mm*28mm	132mm*80mm*20mm (not with the L-type Bracket and Mounting Bracket)
Net Weight	30g	170g





Litemons video light series is a set of entry-level tools designed to make your journey of the content creation much easier, a portable, ease-of-use and budget-friendly lighting solution to which our LED6R/LED6Bi belongs. Small but versatile, the two lights are made for different needs. For creators who'd love to play with colors and try dramatic effects, the RGBWW LED6R won't let you down. Otherwise, try LED6Bi if you only need a simple bi-color solution. Working with camera or smartphone, the Litemons series is always your best choice for vlogging, YouTube video, party lighting, selfie, portrait, product photography and more.

Key Features

- Compact and portable
- High CRI/TLCI rating of 95+/96+
- Adjustable color temperature from 3200K-6500K
- Comaptible with collapsible diffusers for soft and variable light effects
- LC30D features 8 FX light effects while LC30Bi has 11 FX light effects
- Handheld freedom with grip and battery box in the accessory kit ML-AK
- Run with AC adapter or two NP-F970 batteries (optional)

Tech Specs

Model	LC30D	LC30Bi
Power Supply	DC14V	DC14V
Power	Max.33W	Max.38W
Color Temperature	5600K	3200K-6500K
FX Type	8	11
Brightness Range	0%-100%	
CRI≈	95	
TLCI≈	96	
Working Environment Temperature	-10°C~40°C	
Dimension	≈76*76*92mm	≈76*76*92mm
Net Weight	≈299g	≈299g

Illuminance Data

LC30D		0.5m	1m	2m
CTT	Illuminance unit			
5600K	lux	35800	9600	2500
	fc	3300	900	230
LC30Bi		0.5m	1m	2m
CTT	Illuminance unit			
3200K	lux	28200	6750	1830
	fc	2110	627	170
4300K	lux	30100	8890	2420
	fc	2800	826	225
5600K	lux	27300	8010	2190
	fc	2540	745	204
6500K	lux	25200	7320	2010
	fc	2340	680	187

All the above tests are based on the condition of 100% brightness



LED6R

LED6R Bi



36000 colors



Light Effects



Magnet Absorption



Use in Combination



Type-C Port

Litemons video light series is a set of entry-level tools designed to make your journey of the content creation much easier, a portable, ease-of-use and budget-friendly lighting solution to which our LED6R/LED6Bi belongs. Small but versatile, the two lights are made for different needs. For creators who'd love to play with colors and try dramatic effects, the RGBWW LED6R won't let you down. Otherwise, try LED6Bi if you only need a simple bi-color solution. Working with camera or smartphone, the Litemons series is always your best choice for vlogging, YouTube video, party lighting, selfie, portrait, product photography and more.

Key Features

- Pocket-sized and ultra-lightweight
- RGB/CCT & 3200 to 6500K Color Temperature
- 0 to 100% Brightness Dimming
- Built-In Display Panel
- Integrated 1800mAh Lithium Battery
- Magnetic Mounting
- Cold Shoe Mounting Foot & 3 x Cold Shoes
- Vertically & Horizontally Stackable

* RGB mode, FX mode, magnetic design (only for LED 6R)

Tech Specs

	LED6DR	LED6DBi
Built-in Lithium Battery	1800mAh	1800mAh
Power Source of Charging	5V/2A	5V/2A
Power	Max. 6W	Max. 6W
Color Temperature Range	3200K-6500K	3200K-6500K (in 9 levels)
100% Illuminance(LUX)(0.5m)(s)	270	360
CRI(=)	95	95
Brightness Range	0%-100%	in 10 levels
Duration	2H-10H	1.5H-10H
Working Environment Temperature	-10-40°C	-10-40°C
Dimension	77*66*30mm	77*66*30mm
Net Weight	110g	110g

Litemons LED Light

LA150D/LA200D/LA150Bi/LA200Bi



LA150 D

LA200 Bi

Godox has launched many successful products and wins the support and admiration of our customers. But the further we go, the more responsibility we feel like taking on to contribute to the development of the industry. Aiming at providing an accessible light solution to whoever wants to start creation, we are excited to introduce the budget-friendly Litemons LA150D/150Bi/200D/200Bi. With different output and daylight/bi-color versions to choose from, the LA series can meet various needs for YouTubers, live streamers, video makers, commercial producers and more.

Key Features

- Compact but powerful, with 101000 lux output at 1 meter (LA200D with reflector)
- Stepless brightness adjustment from 0 to 100%
- Bi-colored LA150Bi/LA200Bi is adjustable from 2800-6500K
- High CRI/TLCI rating of 96+/97+ ensures natural and faithful colors
- Godox Light APP available
- LA150D/LA200D features 8 FX light effects, including Flash 1, Flash 2, Flash 3, Storm 1, Storm 2, Storm 3; LA150Bi/LA200Bi adds another three light effects: Candle, Fire and Firework.
- Compatible with any Bowens mount light shapers
- Built-in umbrella mount



Litemons LED Light

LA150D/LA200D/LA150Bi/LA200Bi

LA150D

CCT Distance	Testing Condition	Illuminance Unit	1m	2m	3m
5600K	bare bulb	lux	7030	1860	903
		fc	653	172	83.8
	with reflector	lux	84800	17800	7610
		fc	7880	1650	707

LA200D

CCT Distance	Testing Condition	Illuminance Unit	1m	2m	3m
5600K	bare bulb	lux	8670	2170	1050
		fc	806	201	97.6
	with reflector	lux	101000	20800	8670
		fc	9360	1930	806

LA150Bi

CCT	Testing Condition	Illuminance Unit	1m	2m	3m
2800K	bare bulb	lux	3020	806	409
		fc	281	74.8	38
3200K		lux	3550	947	483
		fc	329	88	44.9
4300K	lux	5030	1350	688	
	fc	468	125	63.9	
5600K	lux	5080	1360	695	
	fc	472	126	64.5	
6500K	lux	4400	1180	600	
	fc	409	110	55.7	

LA200Bi

CCT	Testing Condition	Illuminance Unit	1m	2m	3m
2800K	bare bulb	lux	3570	951	478
		fc	331	88.4	44.4
3200K		lux	4350	1160	586
		fc	404	108	54.5
4300K	lux	6850	1840	924	
	fc	637	171	85.8	
5600K	lux	6970	1870	937	
	fc	647	174	87	
6500K	lux	5630	1510	774	
	fc	523	140	71.9	

LA150Bi

CCT	Testing Condition	Illuminance Unit	1m	2m	3m
2800K	with reflector	lux	37700	8150	3340
		fc	3500	757	310
3200K		lux	44800	9660	3970
		fc	4170	897	369
4300K	lux	64900	13900	5740	
	fc	6030	1290	534	
5600K	lux	66600	14400	5890	
	fc	6190	1340	547	
6500K	lux	58300	12400	5150	
	fc	5420	1150	479	

LA200Bi

CCT	Testing Condition	Illuminance Unit	1m	2m	3m
2800K	with reflector	lux	39300	8440	3550
		fc	3650	785	330
3200K		lux	48500	10400	4340
		fc	4510	964	403
4300K	lux	77400	16400	6890	
	fc	7190	1520	640	
5600K	lux	79200	16800	7030	
	fc	7360	1560	653	
6500K	lux	64300	13600	5670	
	fc	5970	1260	527	

Tech Specs

Model	LA150D	LA150Bi	LA200D	LA200Bi
Power	Max.190W	Max.190W	Max.230W	Max.230W
Input Voltage	DC 48V	DC 48V	DC 48V	DC 48V
CCT	5600K	2800-6500K	5600K	2800-6500K
Brightness Adjustment Range	0%-100%	0%-100%	0%-100%	0%-100%
CRI ≈	96	96	96	96
TLCI ≈	97	97	97	97
FX Mode	8	11	8	11
Controlling Method	Manual Control, Bluetooth APP Control	Manual Control, Bluetooth APP Control	Manual Control, Bluetooth APP Control	Manual Control, Bluetooth APP Control
Bluetooth Transmission Distance	30m	30m	30m	30m
Working Environment Temperature	-10°C-40°C	-10°C-40°C	-10°C-40°C	-10°C-40°C
Bluetooth Transmission Frequency	2402.00-2480.00MHZ	2402.00-2480.00MHZ	2402.00-2480.00MHZ	2402.00-2480.00MHZ
Maximum Transmit Power	5dbm	5dbm	5dbm	5dbm
Dimension	205*145*215mm	205*145*215mm	205*145*215mm	205*145*215mm
Net Weight≈	1.4kg	1.4kg	1.4kg	1.4kg

GODOX CONTROL



APP Control



Godox Light App, the wireless control system for Godox LED lights, has been upgraded to an optimal version 3.0, aiming to provide users with maximum convenience and efficiency at hand. Based on mesh Bluetooth transmission, Godox Light allows for fast and stable connection of Godox LED lights.

Key Features

- Fast and stable connection based on mesh Bluetooth transmission.
- User-friendly UI and well-organized menu.
- Group function to achieve synchronous control over multiple fixtures.
- Multiple adjustment methods: HSI, RGB, X/Y, GEL and Color Picker.
- More precise control over unique pixel effects.
- Favorites and date share function to enable a seamless workflow.
- More details: Quick Switch & Find Light function.
- Supporting both iOS and Android systems.

Remote Control



RC-R9II

RGB 2.4GHz Remote Control
 Group: 16 Channel: 32 ID: 99
 Light Brightness Adjustment Range:
 0% to 100%
 Freely adjust multiple beautiful colors
 and color temperature from
 2500K to 8500K
 Compatible with:
 TL60, TL120, TL180, SZ150R, SZ300R
 LC500R, LD75R, LD150R, LD150Rs



RC-A6II

2.4GHz Remote Control
 Group: 16 Channel: 32
 Light Brightness Adjustment Range:
 0% to 100%
 Compatible with:
 LF308D, LF308Bi, FV150, FV200, SL100D,
 SL100Bi, SL150II, SL200II, S60, S60Bi, ML30,
 ML30Bi, ML60, ML60Bi, SZ200Bi, SL60II,
 SL150III, SL200III, SL300III, VLII, UL60, UL60Bi,
 UL150II, UL150IIBi, M200D, M200Bi, M300D,
 M300Bi, M600D, M600Bi, MG1200Bi



RC-A5II

433MHz Remote Control
 Group: 6 Channel: 16
 Light Brightness Adjustment Range:
 0% to 100%
 Compatible with:
 LC500, SL150W, SL200W,
 SL60W, SL60Y, FL100, FL150R, FL150S,
 FL60, LED308, LED380II, LED500L,
 LED500LR, LEDP260C, SLB60W, VL150,
 VL200, VL300, LED1000BiII, LED1000DII,
 UL150



TimoLink RX

TimoLink TX

Built with CRMX modules from Lumenradio, TimoLink TX and TimoLink RX are wireless DMX transmitters and receivers compatible with Godox or other fixtures featuring DMX control capabilities.

The transmitter TimoLink TX converts a wired DMX console to wireless by sending signals to CRMX-compatible fixtures (such as MG1200Bi and TP Series) or receivers. As for the receiver TimoLink RX, it works perfectly with DMX-compatible fixtures that do not include wireless modules (such as LD Series and some of UL Series, TL Series and KNOWLED M Series) and enables them to achieve wireless DMX control. TimoLink TX and TimoLink RX are ideal for filmmaking, broadcasting and other scenes where wireless DMX is needed.

Key Features

- Automatic frequency hopping ensures stable signals within 300m.
- 270° rotatable connectors for wider compatibility with different interface designs.
- Separately designed SET button and RESET button simplify operation logic and enhance efficiency.
- The TEST feature for TimoLink TX can help check the connection status of lights even off the DMX board.



Optional Purchase



RJ45 to 5-Pin XLR Conversion Cable
TL-C120

RJ45 Ethernet to 5 Pin XLR Conversion Cable allows you to run standard 5 Pin DMX cable to the Godox lights or any light fixture with RJ45 DMX input connectors.

Tech Specs

Name	Wireless DMX Transmitter	Wireless DMX Receiver
Model	TimoLink TX	TimoLink RX
Input Parameter	5V=280mA	5V=90mA
Colors of Signal Indicator	8	8
Power Supply Port	Type-C	Type-C
Compatible Models	DMX512 Controller / DMX240 Controller (incompatible with New Sunny 512 Controller)	Fixtures with DMX functions
DMX Plug Rotatable Angle	270°	270°
Controlling Distance	Max. 300m (in an open and barrier-free environment)	Max. 300m (in an open and barrier-free environment)
Working Environment Temperature	-20~45°C	-20~45°C
Dimension	141mm*96mm*26mm	110mm*53mm*26mm
Net Weight	89g	80g



LENS & GOBOS



Godox offers a complete Fresnel system, allowing all Godox COB lights to easily enhance their intensity with a compatible Fresnel lens, regardless of their mount. Built with class-leading technology to intensify the LED light, the Fresnel lenses empower your lights to deliver an even brighter beam and render consistent luminescence with smooth intensity.

Key Features

- **Intensify the Output**
The Godox Fresnel Lenses can multiply the output of Godox LED lights.
- **Variable Beam Angle**
Beam thrown by the Fresnel Lenses can be adjusted from a spot angle to a flood one.
FLS5: 10°-35°/FLS8: 10°-40°/FLS10: 10°-35°
- **Robust Construction**
The ergonomic and sturdy build of the Godox Fresnel Lenses ensures minimized light leaks and rugged durability.
- **Compatible with Barndoors**
Compatible with the Godox 8-leaf barndoors to precisely cut and shape the light for more creative expressions.



FLS5+LB-03

FLS5 is compatible with Godox LED lights which adopt Godox Mount, such as ML60, ML60Bi, ML30, ML30Bi.

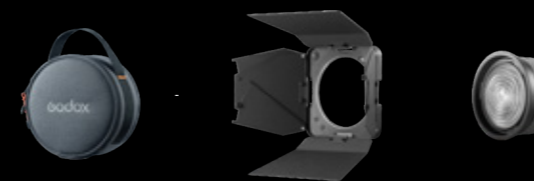

FLS10+LB-02

FLS10 is compatible with all Godox Bowens Mount LED lights.

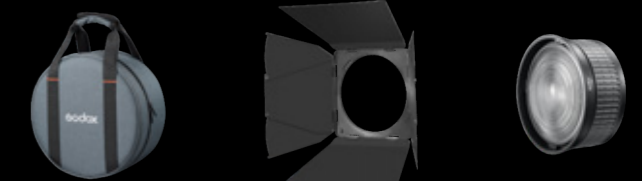

FLS8+LB-01

FLS8 is compatible with the majority of Godox Bowens Mount LED lights.

*M600D and M600Bi are incompatible owing to their particular rings.

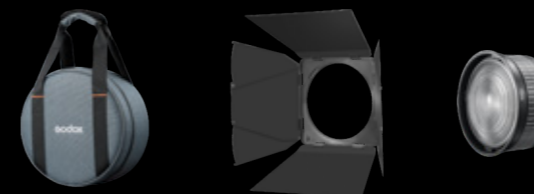

Tech Specs

Model	FLS5	FLS8	FLS10
Adjustable Beam Angle	10° - 35°	10° - 40°	10° - 35°
Working Temperature	-10°C-40°C	-10°C-40°C	-10°C-40°C
Dimension	147*147*61mm	246*246*121mm	295*295*135mm
Weight	0.42kg	2kg	3kg

Projection Attachment

VSA-36K/VSA-26K/VSA-19K



With three optional lenses, the powerful creating tool is designed with utmost precision to grant the LED lights with even, crisp, and clear beam and brings you with an endless source of inspiration.

Key Features

- Throwing an evenly intensified illumination circle without shifting in color and brightness from center to edge.
- Adopting a class-leading lens system to eliminate aberration to strike an incredible crisp beam of light with sharp-edge projection
- Bring you ultra fun to create by cutting, shaping, focusing, and coloring the light.
- Interchangeable lens in 19°, 26°, 36°.
- Bowens mount for wide compatibility.
- Robust yolk allowing for versatile shooting scenarios.

Dimension and Weight

Spotlight Attachment Kit Model	VSA-19K/ VSA-26K/ VSA-36K
Spotlight Attachment Dimension (excluding Lens)	516*241*196mm
Lens Dimension	135*219*137mm
Spotlight Attachment Weight (excluding Lens)	3.42kg
Projection Lens 19° Weight	1.94kg
Projection Lens 26° Weight	1.75kg
Projection Lens 36° Weight	1.92kg

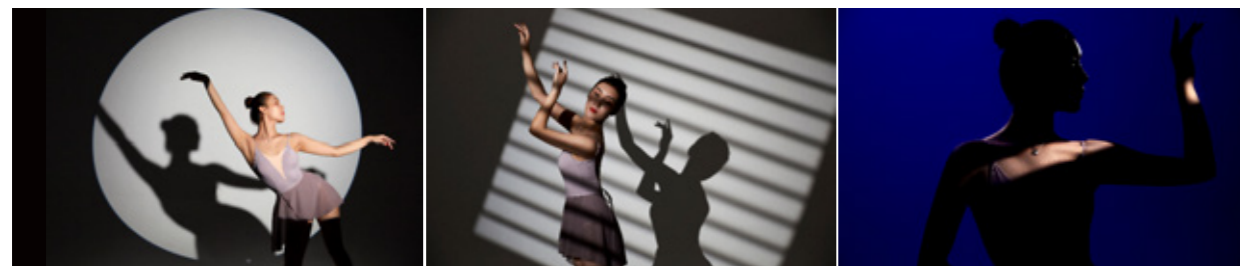

Projection Attachment

VSA-36K/VSA-26K/VSA-19K

Dimension and Weight

LED Video Light	CCT	Spotlight Attachment	Lens	Illuminance			
				Unit	3m	4m	5m
VL300	5600 100%	NO	NO	Lux	1380	860	602
				Fc	128.3	79.9	55.9
		YES	Projection Lens 19°	Lux	7530	4040	2400
				Fc	699.8	375.5	223
		YES	Projection Lens 26°	Lux	5130	2830	1720
				Fc	476.8	263	159.9
	YES	Projection Lens 36°	Lux	4200	2330	1430	
			Fc	390.3	216.5	132.9	

Note: The above luminance and CCT values are all average numbers, the illuminance values of different lights vary slightly.

Optional Purchase

- Gobo Set VSA-GS1
- Gobo Set VSA-GS2
- Gobo Set VSA-GS3
- Gobo Set VSA-GS4
- CCT Adjustment Set VSA-11T
- CCT Adjustment Set VSA-11C
- Iris Diaphragm VSA-ID
- Lens Portabe Bag



VSA-19K Kit

- Spot Light Mount x1
- 19° lens x1
- Gobo Holder x1
- Gobo x3
- Gel Frame x1
- Portable Bag x1



VSA-26K Kit

- Spot Light Mount x1
- 26° lens x1
- Gobo Holder x1
- Gobo x3
- Gel Frame x1
- Portable Bag x1



VSA-36K Kit

- Spot Light Mount x1
- 36° lens x1
- Gobo Holder x1
- Gobo x3
- Gel Frame x1
- Portable Bag x1





Meet the BLP, where creativity merges with playfulness. 360° rotatable design allows for effortless adjustment of projection patterns. And with superior heat management, expansive lens options, and endless creative accessories, the BLP serves as a perfect tool for artists and creators. Beyond just lighting, the BLP is a catalyst for artistic brilliance.

Key Features

- 360° Rotatable Design
- Expertly Crafted Lenses for Clear & Sharp Visuals
- Superior Heat Management
- Expansive Lens Options (48mm, 65mm, 85mm, and 150mm)
- Versatile EF-Mount
- Bowens Mount for Wide Compatibility
- Abundant Creative Accessories



The lens barrel can be rotated 360°

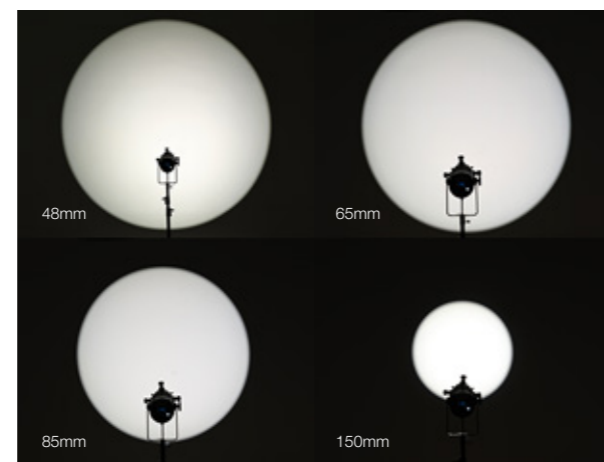

Enrich lens ecology

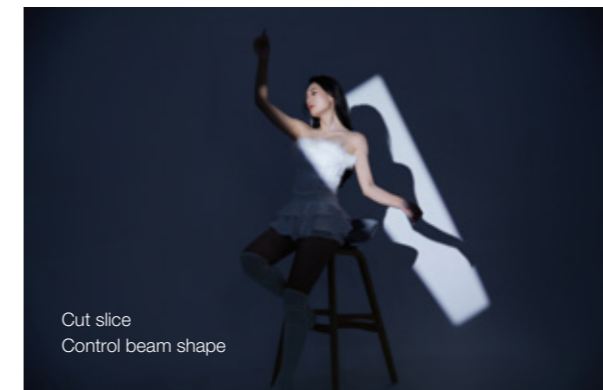

Cut slice
Control beam shape

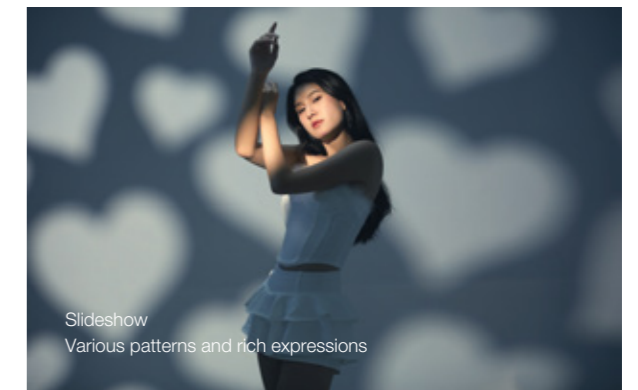

Slideshow
Various patterns and rich expressions

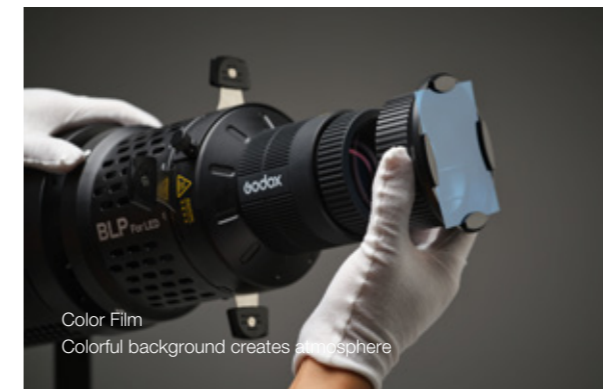

Color Film
Colorful background creates atmosphere

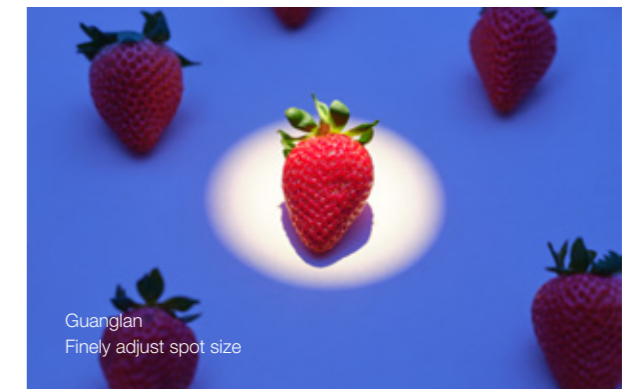

Guanglan
Finely adjust spot size

Optional Purchase



Tech Specs

Projection Attachment	Dimension	Net Weight
(excluding lens)	220*220*166mm	≈1.3kg
48mm Lens	104*104*160mm	≈1.2kg
65mm Lens	80*80*72mm	≈0.5kg
85mm Lens	80*80*88mm	≈0.5kg
150mm Lens	80*80*129mm	≈0.7kg

illuminance Data

Distance	illumination unit	Bare lamp M300Bi	65mm	85mm	150mm
3m	LUX	≈1570	≈1170	≈1930	≈4890
	FC	≈146	≈109	≈179	≈454
4m	LUX	≈825	≈655	≈1090	≈2730
	FC	≈76.6	≈60.8	≈101	≈254
5m	LUX	≈531	≈420	≈692	≈1710
	FC	≈49.4	≈39	≈64.3	≈159



Compatible with the compact ML Series lights which adopts Godox mount, the projection attachment MLP Series is crafted for creators, ready to illuminate your artistic vision. From evenly intensified lighting to flawless optical results, the MLP Series offers stunning precision and versatility. With various accessories, it empowers you to explore endless creative possibilities.

Key Features

- Evenly intensifying the illumination
- Class-leading lens system to ensure a crisp and clear beam without aberration
- Rotatable lens barrel for convenient orientation adjustment
- Various accessories for creative expressions
- Three interchangeable lenses 19°, 26°, and 36°

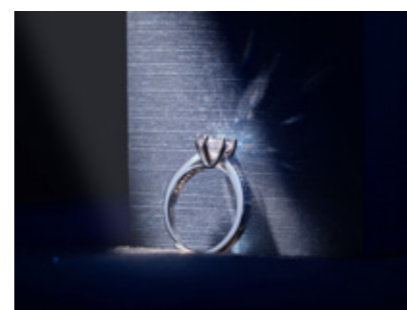
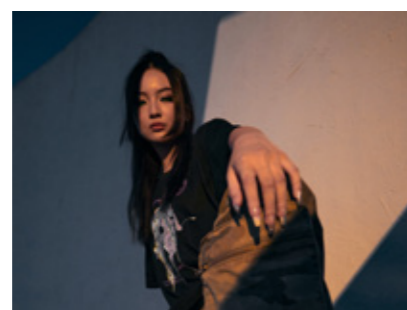
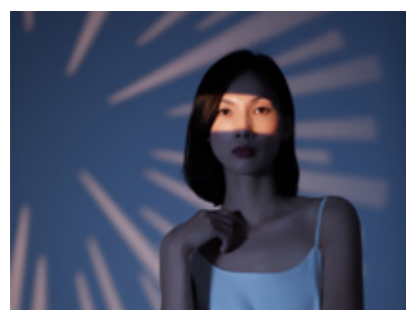

Optional Purchase



Tech Specs

Model	Dimension	Weight
Projection attachment (including lens)	237*219*277mm/9.3*8.6*10.9"	≈1.43kg
Lens 19°	131*118*150mm/5.2*4.6*5.9"	≈1.22kg
Lens 26°	131*118*150mm/5.2*4.6*5.9"	≈1.05kg
Lens 36°	131*118*150mm/5.2*4.6*5.9"	≈0.99kg

illuminance Data (with ML60)

CCT	Lens	Unit	2m	3m	5m
5600K	Bare light	Lux	618	286	109
		Fc	57.5	26.5	10.1
	Lens 19°	Lux	8300	3560	1230
		Fc	793	328	113
	Lens 26°	Lux	5520	2410	840
		Fc	523	220	77
	Lens 36°	Lux	2970	1320	462
		Fc	283	120	42.6

ACCESSORIES

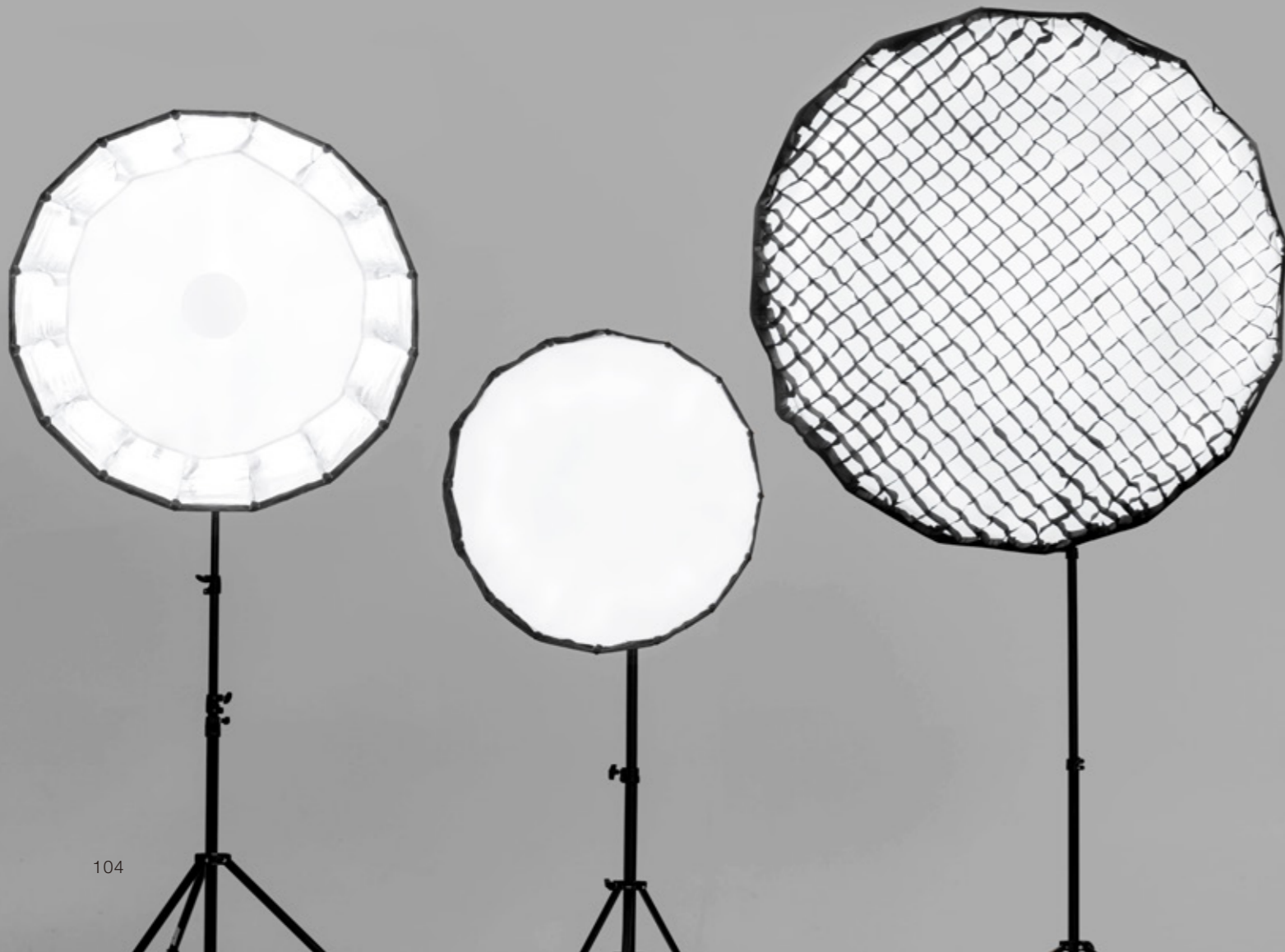

Projection Attachment

SA-17



Godox SA-17 Adapter for Bowens-mount LED lights to Projection Attachment, with its solid construction, allows you to use Godox SA-P Projection attachment with any of your Bowens-mount LED Lights for achieving a greater degree of control with your light.

Extending the SA-P Projection Attachment's Compatibility
The adapter allows COB Bowens-mount LED lights users to release their boundless creativity by matching with SA-P projection attachment to achieve their desired effects. For users who already own S30 focusing light, now they can go beyond S30 and use the adapter to serve for a broader range of Bowens-mount LED lights. Equipped with built-in optical lens, the adapter provides excellent optical performance, assuring light output that's even from edge to edge.

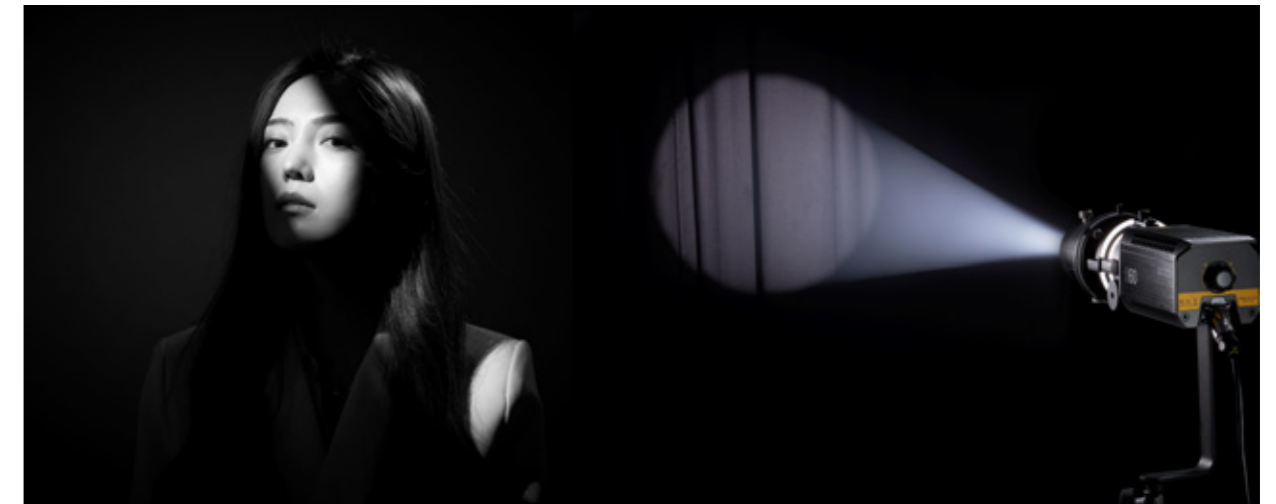

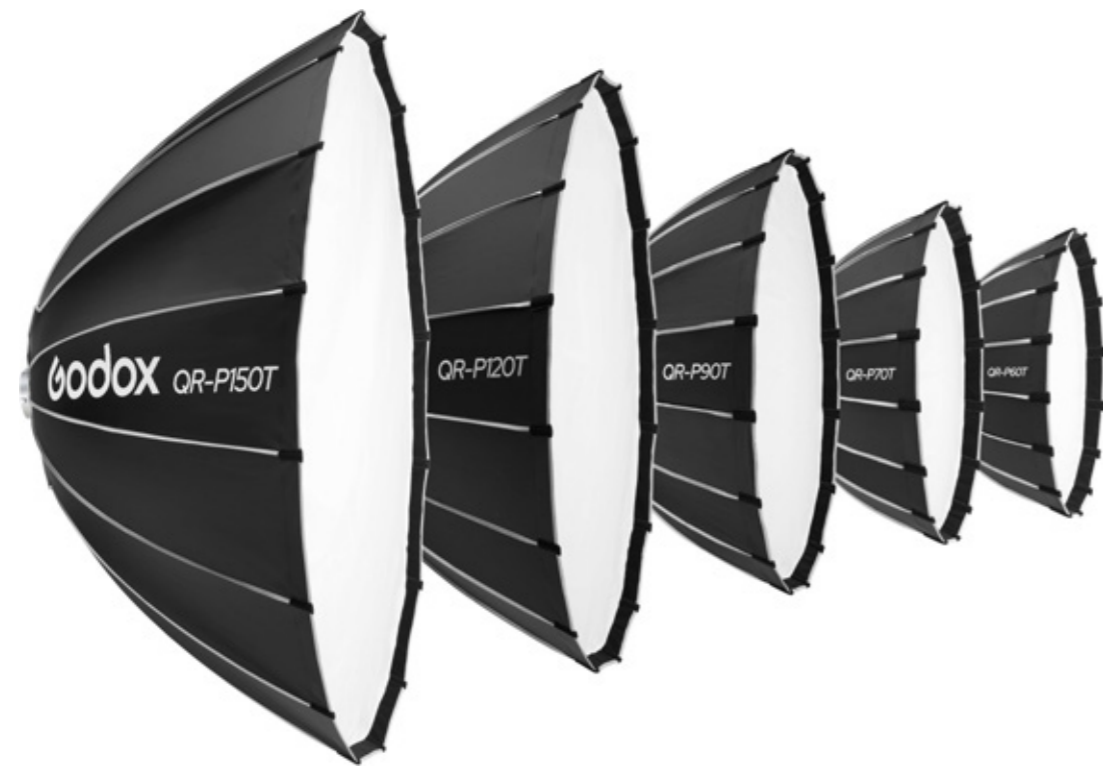

QR-P150T QR-P120T QR-P90T QR-P70T QR-P60T

QR-P series boasts a more compact design in comparison to its predecessors within the same series. Crafted as a softbox tailored for small-space live streaming and video production, its quick-release system simplifies setup and breakdown. The internal diffuser design, tightly connected with Velcro, ensures perfect diffusing result. Available in five diameters (2', 2.3', 3', 4', and 5'), it proves to be the ideal companion for on-site and small-space shooting.

Key Features

- Compact & space-saving
- Quick-mount design enables easy setup and dismantling
- Double-layered soft light cloth for dual soft light effects
- Optional grids for precise light control
- Grid models: QR-P60T-G, QR-P70T-G, QR-P90T-G, QR-P120T-G, QR-P150T-G
- Bowens mount, compatible with optional mounting plates for versatility

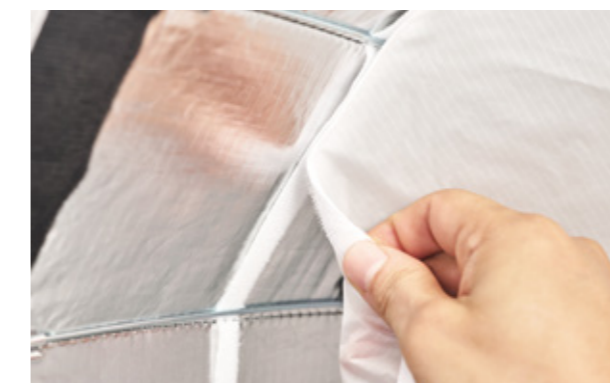
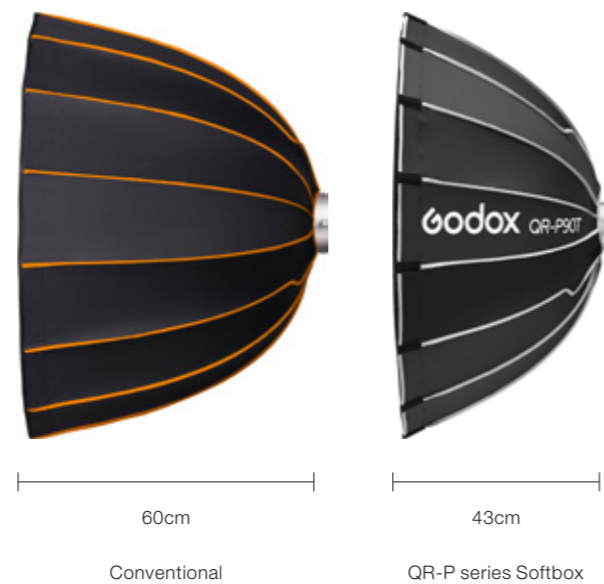

The inner diffuser is closely attached to the softbox with Velcro, ensuring perfect diffusing result.

Bowens-Mount Capability

SA-GD(optional)
Speed Ring for Godox



SA-PF(optional)
Speed Ring for Profoto



SA-BR(optional)
Speed Ring for Broncolor

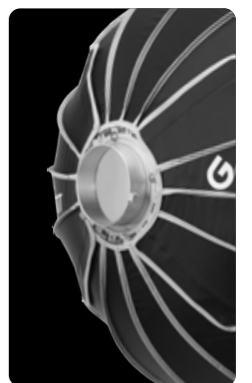

Tech Specs

Model	Net Weight	Dimension(Depth x Diameter)
QR-P60T	0.771kg	29.8*60cm
QR-P70T	0.830kg	34.1*70cm
QR-P90T	1.359kg	42.7*90cm
QR-P120T	1.781kg	56.7*120cm
QR-P150T	2.386kg	70.2*150cm



QR-P60T/P70T/P90T/P120T/P150T

Softbox	x1	Inner Fabric Diffuser	x1
Front Fabric Diffusers	x1	Carring Bag	x1



CS-50T

CS-65T

CS-85T

CS-50T/CS-65T/CS-85T, the ideal soft lighting source for small spaces. With heights ranging from 1.1' to 1.8' when fully expanded, the CS-T series Softbox with a shallower depth offer exceptional versatility in compact settings, emitting soft and uniform lighting in all directions. They are perfect for live streaming and video recordings.

Key Features

- Standing at heights of just 1.1', 1.4', and 1.8'
- Quick-mount design for effortless installation with a single press
- 270-degree beam angle for soft, uniform lighting
- Detachable skirt for precise light control
- Universal Bowens mount, compatible with various lights
- Optional interchangeable mounting plates: SA-PF/SA-BR/SA-GD

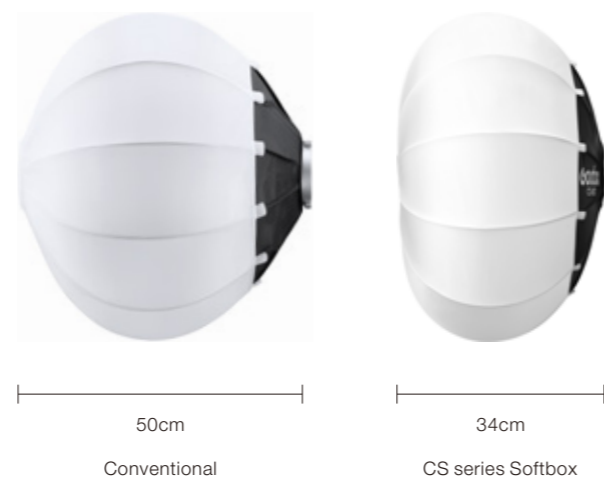

50cm

Conventional

34cm

CS series Softbox



The diffuser is securely fastened to the frame with Velcro tape, keeping the umbrella ribs in place, enabling the Softbox to expand and collapse in just one second, greatly enhancing workflow efficiency.



Achieve precise light control with the detachable skirt, easily attachable to the Lantern, allowing you to eliminate unwanted bouncing light by rolling it up or down.



CS-50T/CS-65T/CS-85T

Softbox x1 Carrying Bag x1

Tech Specs

Model	Net Weight	Dimension (Depth x Diameter)
CS-50T	0.869kg	33.5*50cm
CS-65T	0.129kg	41.8*65cm
CS-80T	1.400kg	54.1*85cm

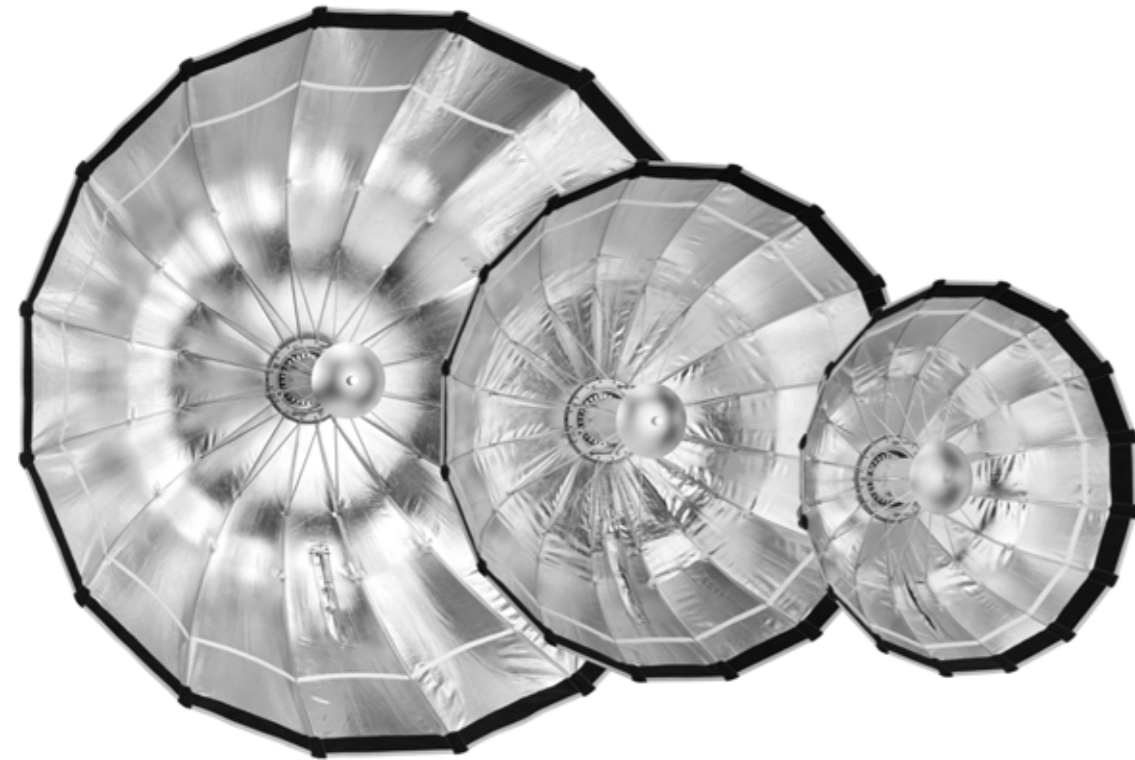

S120T

S85T

S65T

Godox Quick Release Umbrella Softbox adopts an effortless quick-release mechanism for hassle-free set-up and breakdown. Highly versatile and compact, the Quick Release Umbrella Softbox ensures efficient creation. Available in 3 different sizes, the Godox Quick Release Umbrella Softbox adopts an effortless quick-release mechanism for hassle-free set-up and breakdown. Highly versatile and compact, the Quick Release Umbrella Softbox ensures efficient creation. Available in 3 different sizes, the lightweight quick-release softbox is your ideal choice for home, studio, and travel.

Key Features

- Quick Release Mechanism
- Crafted with shadow design (11.8inch depth)
- Lightweight Beauty Dish
- Versatile Compatibility
- Compact and portable



Designed for shooting on-the-go, it is foldable and highly portable, ideal for location, ensuring convenience wherever you are.

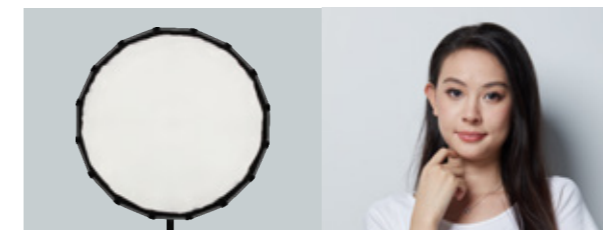
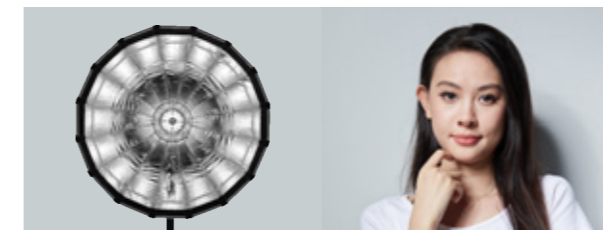

With the deflector plate (optional) and the silver interior, you can have a soft look but with an edge of crispness, just like the lighting effects achieved by a beauty dish, but a more lightweight one.



S65T/85T/120T

Softbox	x1	Inner Diffuser	x1
Carring Bag	x1	Front Diffuser	x1

Optional

Grid	Deflector Plate	Speed Ring
S65T-G	S65T-P	SA-GD for Godox
S85T-G	S85T-P	SA-BR for Broncolor
S120T-G	S120T-P	SA-PF for Profoto

Tech Specs

Model	S65T	S85T	S120T
Diameter Open	65cm	85cm	120cm
Depth Open	30cm	38cm	49cm
Collapsed Softbox Length	42cm	56cm	78cm
Net Weight	0.851kg	1.016kg	1.424kg



AD-S60S

Compatible with AD300Pro/ML60/ML60BI, comes with grids

Godox AD-S60S is a dedicated softbox with silver interior finish and parabolic reflecting shape to deliver indirect lighting and create distinct contrasts. The softbox has native Godox mount to snap onto the AD300Pro or ML60/ML60BI in no time, comes with two levels of diffusion to create degrees of increased softness, includes grids for extra beam directing, and has zippered slot for cables and cord placement on the side.



The Godox mount softboxes comes with a grid that eliminates spill light and provides the directional control that facilitates selective lighting.

AD-S65S / AD-S65W

Compatible with AD300Pro/AD400PRO/ML60/ML60BI, comes with grids

The parabolic softbox has two model AD-S65S with silver lining and AD-S65W with white lining. AD-S65 softbox adopts parabolic box design to offer soft and even light effects for shooting. The shape of the softbox allows the user to control precisely where the light falls and soften the light stream and is built on the basis of a quick folding mechanism.



If you want a cool-toned look with snappy contrast, attach the silver reflector inside the umbrella. If you want a soft, warm rendition attach the gold reflector. The removable front diffuser makes it easy.

AD-S85S / AD-S85W

Compatible with AD300Pro/AD400PRO/ML60/ML60BI, comes with grids

With deep design to output soft light with a sharp falloff, Godox AD-S85 makes feathering and edge-lighting simple. The included fabric grid thwarts spill light and offers directional control necessary for selective lighting. Its quick-folding mechanism allows you to set up and break down quickly.

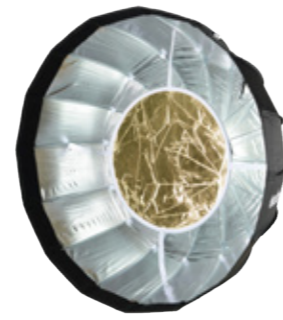

CS-85D / CS-65D

Godox Collapsible Lantern Softbox CS-85D/CS-65D is perfect for use overhead or to raise the ambient illumination level. With a 270 degree beam angle, the light is ideal for video recording, live streaming, film making, and still life photography.

Key Features

- Extremely Fast Setup
- Stunning, Soft, Omni-Directional Light
- Bowens Mount Compatibility
- Optional skirts for beam spread control



Thanks to its simple and durable design, this softbox is a breeze to use. The lantern can be popped open or closed in mere seconds.

Purchase skirt for achieving better light control Skirt Set for Lantern Softbox (Available for Purchase)SS-65 for CS-65D / SS-85 for CS-85D





P90L / P90H

Godox Parabolic Softboxes are the essential modifier for commercial, fashion, and portrait photographers. There are two version for choice, P90L for Lighy Version and P90H for High Temperature Resistant Version. P90L/P90H series adopt deep parabolic box design, which enables light to be sent out straightly and brightness, offering even, soft, and high saturation light effects for shooting with easy installation, great portability. P90L/P90H comes with removable one-stop outer and inner diffusers to achieve different levels of contrast. A carry bag is included for storage and transport.

P120L / P120H

Godox P120L/P120H softbox is useful for stunning fashion and portraiture images. Same as P90L/P90H, the P120 softbox also has two version. P120L/P120H is a 16-sided light-shaper offering focused, soft output with a punchy, crisp edge that lends dimension and detail to your subject as well as natural-looking catchlights in their eyes. The parabolic design yields soft, focused light with a crisp edge. With removable outer and inner diffusers, it can achieve desired contrast. A carry bag is included for storage and transport.

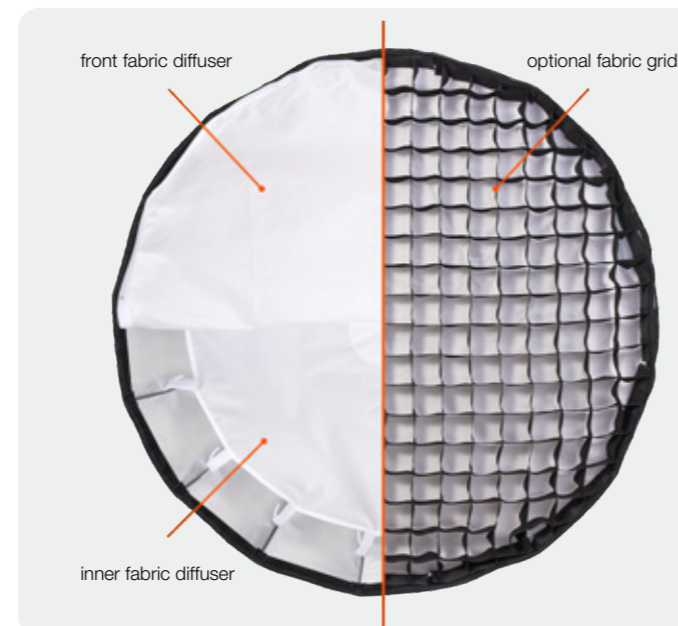

QR-P70 / P90 / P120

The Godox quick release parabolic softbox adopts an impressive quick release system for rapid setup and breakdown. Highly versatile and compatible, it provides you reliable light quality and various creative expressions. Available in three different sizes, this fast and easy to use softbox is deal companion for your indoor and on location shootings

Key Features

- Reflective silver interior to render a punchy high contrast
- Removable inner and front fabric diffusers
- Impressive quick release system for rapid setup and breakdown
- Reliable light quality and various creative expressions
- Bowens mount strobes and continuous light compatible

Each of the parabolic softboxes (P90L/H & P120L/H) as well as QR Quick Release Parabolic Softboxes have a reflective silver interior with a black outside. There are also removable inner and front fabric diffusers that clip into both the parabolic softbox and quick release parabolic softbox, as well as an optional fabric grid to narrow down the beam spread for more precise control.

Removable inner and front diffusers, giving you brightness & contrast. The collapsible grids (optional) narrows the beam spread of the softbox.

Grids

- P70-G for QR-P70
- P90-G for P90L/H QR-P90
- P120-G for P120L/H QR-P120

Parabolic Softbox | Quick Release Bowens Mount

QR-P70 / P90 / P120

Compatible with any flash head or monolight that uses the popular Bowens accessory mount; The softbox can also mount with Godox mount and Profoto mount accessory via attaching the SA-GD Godox mount adapter (optional) and SA-PF2 Profoto mount adapter (optional). And speed ring SA-BR2 is for adapting Broncolor lights.



As it folds down into an easy carry bag, it's extremely portable and therefore ideal to use on location.



Effortless Softbox Setup

The easiest way to put the softbox up is to click two rods on opposite sides up at the same time. Once they're all clicked into place, you simply Velcro the top panels of the softbox together to prevent light leakage.



To take the softbox down again, you simply lift the rod slightly whilst pressing down the button above it.

In this way, you can have the softbox assembled in mere minutes.



Softbox | Bowens Mount

Godox offers softboxes with Bowens mounting, which fits most of Godox flash heads or other brands with the widely used Bowens front accessory mount. Ideal for all types of photo work, Godox softboxes render a soft, flattering quality of light with manageable contrast. There are SB-FW Series, SB-USW Series, and SB-GUE Series include grids to offer directional control of the output, keeping light off the background, and allowing you to light specific areas of your subject.



Square Softbox

Model: SB-BW-6060/9090
Sizes (W x H): 60x60cm, 90x90cm

Rectangular Softbox

Model: SB-BW-6090/70100/80120
Sizes (W x H): 60x60cm, 70x100cm, 80x120cm

Strip Softbox

Model: SB-BW-50130/35160
Sizes (W x H): 50x130cm, 35x160cm

Octagon Softbox

Model: SB-BW-95/120/140
Sizes: 95cm, 120cm, 140cm



Square Softbox with Grid

Model: SB-FW-6060/9090
Sizes (W x H): 60x60cm, 90x90cm

Rectangular Softbox with Grid

Model: SB-FW-6090/70100/80120
Sizes (W x H): 60x60cm, 70x100cm, 80x120cm

Strip Softbox with Grid

Model: SB-FW-50130/35160
Sizes (W x H): 50x130cm, 35x160cm

Octagon Softbox with Grid

Model: SB-FW-95/120/140
Sizes: ϕ 95cm, ϕ 120cm, ϕ 140cm

LIGHTING STANDS & MOUNTING

90F

Foldable Floor Light Stand



190F

Adjustable Legs Light Stand

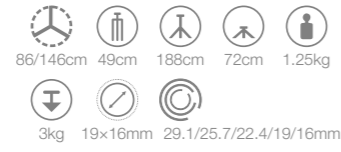

210F

Light Stand

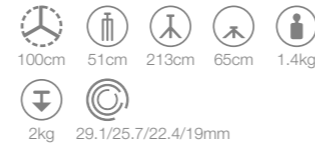

240F

Light Stand



300F

Light Stand



LIGHTING STANDS & MOUNTING

290F

Heavy Duty Light Stand



380F

Heavy Duty Light Stand



240CS

C-Stand with Arm (Silver)



270CS

C-Stand with Arm (Silver)



240FS

Wheeled Light Stand

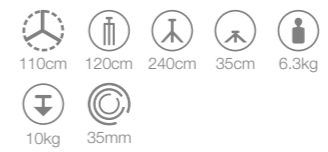

420LB

Light Boom Stand with Weight Bag



LA-300

Light Stand



LA-302

Light Stand



LA-303

Light Stand



LA-304

Light Stand



BS-04

Retractable Background Stand with Carrying Bag



SA5015

Heady Duty Steel Roller Stand



Key Features

- Weight capacity of 40kg.
- Unfolded height ranges from 92cm to 168cm.
- Features adjustable legs for versatility.
- Equipped with a 1-1/8" Junior receiver.
- Comes with a retractable 5/8" pin which can be swung 90 degrees.



SA5045

Heady Duty Steel Roller Stand



Key Features

- Weight capacity of 40kg.
- Unfolded height ranges from 146cm to 450cm.
- Features adjustable legs for versatility.
- Equipped with a 1-1/8" Junior receiver.
- Comes with a retractable 5/8" pin which can be swung 90 degrees.



LIGHTING STANDS & MOUNTING

FH01

Light Boom Holder



Designed for mounting a boom arm to a heavy-duty stand. It makes tilt and swivel adjustments of the boom arm quick and simple.

FH02

Lighting Holder



The FH02 Lighting Holder is designed to accept an umbrella and light or two lights for easy attachment to a standard light stand.

FH03

Reflector Boom Holder



The FH03 Reflector Boom Holder allows you to attach up to two RMA-01 reflector mounting arms onto a light boom.

LSA-14

Boom Extension Arm



Easily extended, good stability, high load capacity.

LSA-15

Boom Extension Arm



This boom arm with clamp features aluminum construction and is telescopically adjustable between 27.5 and 67" in length.

LSA-16

Boom Arm with Reflector Holder



The boom arm has a large handle that allows angle adjustments and locks it in place by friction.

RMA-01

Reflector Mounting Arm

Reflector Mounting Arm can hold a wide variety of reflectors with its plastic clips. The arm mounts to a light stand via its mini grip head which allows it to be turned to obtain the required angle for the desired degree of reflectors.



CARRYING BAG

CB Series

LS-01

Multi-function Clamp



Multi-function Clamp can be installed on the light stand to attach small studio accessories or hang objects.

LS-02

Multi-function Clamp



LSA-19 clamp is compact accessory that allows you to attach with V-mount accessories such as V-mount batteries. Use it with Godox LSA-03 nano clamp you can mount them to a light stand or tripod easily.

LSA-03/LSA-19

Nano Clamp/Clamp



LSA-06

Wheel for Light Stand



Step-On lock design locks the wheel from rolling

LSA-07

Wheel for Light Stand



LSA-08

Flexible Arm



Flexible and strong enough to hold Shoe-Mount strobes at all angles to reduce unwanted reflections

LSA-09

Heavy Duty Flexible Arm



The two arms can be freely adjusted and locked by the knob

LSA-04

Magic Arm



LSA-05

Extension Arm



The extension arm is designed for attaching to a Convi clamp for hanging a light or a camera from a light stand or pole

LSA-13

Sky Hook



For hanging accessories

LSA-11

Laptop Tray



An aluminum platform to hold your laptop on a camera stand. Especially held on the laptop tray LSA-12, the cables of the laptop can be fixed on all edges of the holder with cable ties, thus preventing them being pulled out.

LSA-12

Laptop Tray



LSA-10

Dual Mount Arm



The dual mount arm features four separate mounting points-two heads on the sides of the arm and two heads on a 90°perpendicular angle





CB-32

Dimensions: 46.5*22.5*35cm
Recommended placing items: ML30-K2/ML30Bi-K2



CB-33

Dimensions: 55*24*39cm
Recommended placing items: ML-Kit1/ML-Kit2



CB-23

Dimensions: 37.7*17*8.5cm
Recommended placing items: TL30-K2



CB-39

Dimensions: 77.5*22.5*7.5cm
Recommended placing items: TL60-K2



CB-22

Dimensions: 37.7*26.7*8.5cm
Recommended placing items: TL30-K4



CB-40

Dimensions: 78*36.5*8cm
Recommended placing items: TL60-K4



CB-05

Dimensions: 74*26*27cm
Recommended placing items: SL60W Two Light Kit



CB-08

Dimensions: 52*30*39.5cm
Recommended placing items: LED500C/LED500W/LED500LRC Kit-1/LED500LRC Kit-2



CB-14

Dimensions: 52*15*15cm
Recommended placing items: S30-D light stand



CB-52

Dimensions: 53*16*16cm
Recommended placing items: S60Bi Light stand



CB-04

Dimensions: 78*24*24cm
Recommended placing items: SL100D-K2 / SL100Bi-K2



CB-21

Dimensions: 33*24*61cm
Recommended placing items: S60-D Three-light kit



CB-08

Dimensions: 52*30*39.5cm
Recommended placing items:
LED500C/LED500W/LED500LRC Kit-1/LED500LRC Kit-2



CB-49

Dimensions: 55*26*39cm
Recommended placing items: M300D



CB-51

Dimensions: 38.5*27*64cm
Recommended placing items: S60Bi-K3

CB-64

Dimensions: 57*29.5*24cm
Recommended placing items: VL300II



CB-34

Dimensions: 136*29.5*61cm
Recommended placing items: M600D



CB-37

Dimensions: 57.5*30.5*28cm
Recommended placing items: VSA-19K/VSA-26K/VSA-36K



CB-63

Dimensions: 51*29.5*24cm
Recommended placing items: VL200II



CB-62

Dimensions: 51*29.5*24cm
Recommended placing items: VL150II



CB-47

Dimensions: 125.2cm*29.3cm*12.9cm
Recommended placing items: TL120-K4



CB-65

Dimensions: 36*29.5*64cm
Recommended placing items: M600Bi



CB-66

Dimensions: 69*26.5*29cm
Recommended placing items: FL100-K2 · FL150S-K2 kit