

LITEMONS

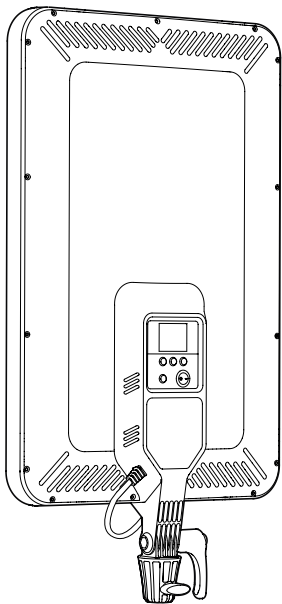

LP800Bi

光小兽双色温 LED 直播面板灯
LITEMONS Bi-Color LED Light Panel

使用手册
Instruction Manual

说明书 / Instruction Manual V1.0 固件 / Firmware V1.00

重要的安全说明及注意事项

本产品为专业灯光布景设备，应由专业灯光师使用或在专业人士指导下使用。使用时必须始终遵循基本的安全预防措施，具体安全预防措施如下：

1. 使用前必须阅读并理解产品说明书。
2. 专业灯具，禁止儿童使用。当儿童靠近时，家长或陪护人必须密切监督，以免儿童因碰撞灯具或私用灯具造成人身伤害。
3. 本灯具并非普通照明灯具，不可用于普通照明，任何有过眼部损伤或眼部敏感的人群均应避免使用本灯具。
4. 灯具点亮时，必须小心使用，禁止接触高温部件，如 LED 灯珠，以免造成灼伤。
5. 倘若灯珠损坏或因热变形，应停止使用，并及时联系制造商、服务代理商或合格的维修人员更换灯珠，以免发生意外。
6. 请勿使用损坏的设备或设备配件，待专业维修人员检查维修，确认设备正常方可使用。
7. 在使用过程中，如果本产品由于跌落、受到挤压或遭受强烈冲击而造成外壳破裂的，请勿继续使用，以免因接触到内部电子元件而受到电击伤害。
8. 请使用本厂原装电源线，如使用非本厂电源线导致产品损坏，一概不在本厂维修范围内。
9. 此设备必须连接至具备可靠接地功能的电源插座使用，在拆装电源线时请先关闭电源，严禁通电时插拔。
10. 在清洁和维修之前，请务必从电源插座上拔下该设备插头。不使用时，禁止拉扯电源线以将设备插头从电源插座中拔出。正常断电，应是用手抓住该设备插头两端，将插头从电源插座中拔出。
11. 请勿私自拆卸产品，如产品出现故障，须由本公司或授权的维修人员进行检查维修。
12. 存放本设备之前，请确保设备已完全冷却。存放时，将电源线从设备上拔出。设备应放置于设备便携包内或通风干燥处。
13. 请勿将设备放置在酒精、汽油等易燃易挥发的溶剂附近。
14. 本厂不推荐的产品附件，请勿使用，以免导致火灾、触电或人身伤害。
15. 清洁本设备时，请勿用湿布擦拭，请用干布，软布擦拭设备污垢。
16. 本设备没有防水性能，请让设备保持干燥，请勿将本设备浸入水中或其他液体中。设备需安装在干燥且通风处，避免在雨天、潮湿、多尘或过热环境下使用。请勿将任何物体置于灯具上或使液体流入灯具内部，以免发生意外。
17. 一经发现，擅自检修设备，将取消一年保修期，维修需要收取相关费用。
18. 安全说明依据本厂严格测试制定，设备设计和规格如有变更，恕不另行通知。客户可以上神牛官网查看最新的电子版说明，了解产品最新资讯。



请勿直视光源

部件名称

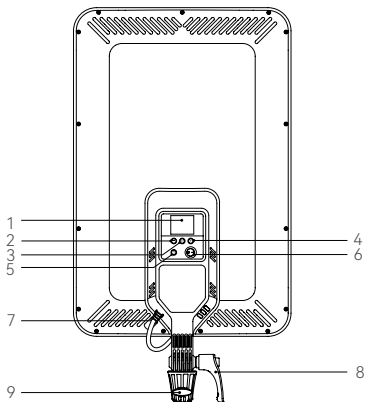

- | | |
|------------------------|-----------|
| 1. 显示屏 | 6. 开关按键 |
| 2.- 按键 (参数递减 / 回退选择) | 7. 电源线 |
| 3.SET 按键 (确认进入) | 8. 方向锁紧把手 |
| 4.+ 按键 (参数递增 / 顺延选择) | 9. 灯架锁紧旋钮 |
| 5. 菜单按键 (进入菜单 / 返回上一级) | |

物品清单

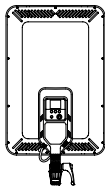

灯体 × 1



LED 直播小型灯架 1.9 米 (BS-3R-FE-190) × 1



说明书 × 1

温馨提示：说明书中线图均为示意图，仅供参考。由于产品不断更新与升级，产品实物与线图可能存在差异，请以实物为准。

开机 / 关机

接通电源后，拨动开关按键至 (I) 实现开机，拨动开关按键至 (O) 实现关机。

菜单设置

短按菜单按键进入菜单界面，短按 <+> 按键顺延选择以下功能，短按 <-> 按键回退选择，选中后短按 SET 进入该项的设置，设置完毕短按菜单按键返回上一级。



CCT

选中 CCT 后短按 SET 进入，在亮度或色温的参数值设置界面，<+/-> 按键用于增 / 减参数值（长按可快调）；短按 SET 退出设置后，<+/-> 按键切换色温 / 亮度选项。

亮度：0% ~ 100%

色温：2800K ~ 6500K

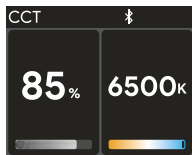

FX

选中 FX 后短按 SET 进入，短按 <+> 按键顺延选择下列光效，<-> 按键回退选择，选中后短按 SET 进入某一类光效的具体设置。



光效	亮度	色温	速度	其他
闪光灯	0% -100%	2800K-6500K	1-100	模式: 闪光灯 / 镁光灯 触发: A 自动 / M 手动
雷闪电		2800K-6500K	×	闪烁次数: 随机 /1-10 频率: 随机 /2-20 触发: A 自动 / M 手动
多云		×	随机 /1-100	亮暗比例: 30%-90%
坏灯泡		2800K-6500K	1-100	×
电视机		×	1-100	×
蜡烛		×	1-100	×
火		×	1-100	×
烟花		×	1-100	余烬: 1-100
爆炸		2800K-6500K	1-100	余烬: 1-100 触发: A 自动 / M 手动
焊接		2800K-6500K	1-100	×
SOS		2800K-6500K	×	×

注: 根据需求短按 <+/-> 按键增 / 减当前参数值 (长按可快调), 设置完毕后短按 SET 退出这一栏设置; 选中 M 手动时, 通过短按一次 SET 触发一次该光效; 某个光效设置完毕后短按菜单按键返回上一级。

蓝牙

选中蓝牙后短按 SET 进入, 短按 SET 再短按 <+/-> 按键循环选择开启或关闭; 设置完毕后短按 SET 退出, 短按 <+> 按键到复位栏, 短按 SET 即处于复位中; 下方查看蓝牙 MAC 码, 方便查找灯具。

“Godox Light”app 下载

扫描二维码即可下载“Godox Light”手机 app (安卓和苹果系统都可以使用)。

注:

1. 首个移动设备 (手机或平板电脑) 可直接使用 app 操控灯体。更换其他移动设备时, 灯体需进行蓝牙重置方可正常使用 app。
2. app 需升级至 V3.0 以上版本。



语言

选中语言后短按 SET 进入，短按 <+/-> 选择需要的语言后短按 SET 完成设置。

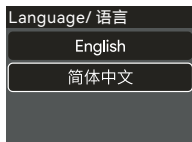

升级说明

选中升级说明后短按 SET 进入，按提示进行灯具固件升级。

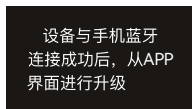

“Godox Light”app 固件升级

手机中打开 Godox Light，进入其中一个场景，点击 <+> (添加设备)，设备添加完成后，点击 <: > 延伸出多项设置，再选择固件升级即可。

注：若 App 升级过程中意外中断导致无法开机，请先拔掉电源线，在完全断电状态下同时按住 +、- 和 SET 三个按键，然后重新接入电源并开机，即可重新进入蓝牙升级界面，继续通过 App 完成升级。

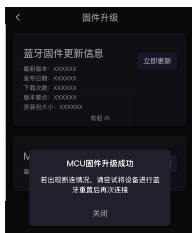

恢复出厂设置

选中恢复出厂设置后短按 SET 进入，短按 SET 确认恢复出厂，灯具将重启，亮度值自动变为 100%再设置需要的语言后跳回主界面。



灯具信息

选中灯具信息后短按 SET 进入，此界面查看灯具基础信息。

照度数据

色温	测试条件	照度单位	1m	2m	3m
2800K	裸灯	lux	1450	391	181
		fc	134	36	17
3200K		lux	1720	463	214
		fc	159	43	20
4300K		lux	1860	502	231
		fc	173	47	22
5600K		lux	1930	521	240
		fc	179	48	22
6500K	lux	1700	459	211	
	fc	158	43	20	

以上数据均为平均值，非绝对值，以上测试皆在灯体 100%亮度下进行。

规格参数

型号	LP800Bi
输入	100V-240V ~ 50/60Hz, 85W
色温范围	2800K ~ 6500K
调光范围	0% ~ 100%
FX 光效	11 类
CRI	≈ 96
TLCI	≈ 98
控制方式	蓝牙、灯体控制
蓝牙控制距离	30m
工作环境温度	-10°C ~ 40°C
尺寸	≈ 343mm*66mm*622mm
净重	≈ 2.3kg

规格和参数如有变更，恕不另行通知。

Important Safety Instructions and Precautions

This product is a professional lighting set equipment and should be used by professional lighting engineers or under the guidance of professionals. Basic safety attentions must always be followed during use, as follows:

1. Before use, please read and understand the instruction manual.
2. Professional lighting is prohibited for children. When children are near, parents or accompanying persons must supervise closely to prevent children from personal injury due to collision with lamps or private use of lamps.
3. This lighting product is not ordinary lighting product and cannot be used for general lighting. Anyone who has suffered eye damage or has sensitive eyes should avoid using this product.
4. When the lamp is on, it must be used with care. Do not touch high-temperature parts, such as LED lamp beads, to avoid burns.
5. If the lamp bead is damaged or deformed by heat, stop using this equipment, and contact the manufacturer, service agent or qualified maintenance personnel to replace the lamp bead in time to avoid accidents.
6. Do not use damaged equipment or accessories, and wait for professional maintenance personnel to check and repair to confirm being normal before use.
7. During using, if the casing of this product is broken due to being dropped, squeezed or subjected to strong impact, please do not use it, so as to avoid electric shock injury due to contact with internal electronic components.
8. Please use the certified power cord from the original manufacturer. If the product is damaged by using a non-certified power cord, it will not be repaired by our factory.
9. This device must be connected to a power outlet with a reliable grounding function. Please power off before connecting or disconnecting the power cord, and never plug or unplug it while the power is on.
10. Be sure to unplug equipment from the power outlet before cleaning and repairing. When not in use, do not pull the power cord to unplug the equipment. For normal power-off, please hold both ends of the plug of the equipment with your hands and pull the plug out of power outlet.
11. Do not disassemble the product without permission. If the product fails, it must be checked and repaired by authorized maintenance personnel.
12. Before storing, make sure that the equipment has cooled down completely. For storage, unplug the power cord from the equipment. The equipment should be placed in the carrying case or in a ventilated dry place.
13. Do not place equipment near flammable and volatile solvents such as alcohol and gasoline.
14. Do not use accessories that are not recommended by our factory to avoid fire, electric shock or personal injury.

15. When cleaning the device, please do not use a wet cloth to wipe, please use a dry, soft cloth to wipe the dirt on the device.
16. This equipment is not waterproof, please keep it dry and do not immerse it in water or other liquids. The equipment should be installed in a dry and ventilated place, and avoid using it in rainy, humid, dusty or overheated environments. Do not place any objects on the lamp or let liquid flow into the lamp to avoid accidents.
17. If it is found that the equipment is repaired without authorization, the one-year warranty period will be cancelled and relevant fees will be charged for maintenance.
18. The safety instructions are formulated according to the strict testing of the factory, and the design and specifications of the equipment are subject to change without prior notice. For latest product information, please check the GODOX website and view latest electronic instruction.



Do not stare at the operating light source.

Names of Parts

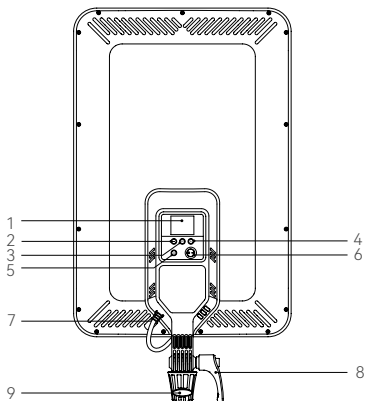

- | | |
|--|-----------------------------|
| 1. Display Panel | 6. Power Switch |
| 2. – Button (decrease parameters/upward) | 7. Power Cord |
| 3. SET Button (confirm to enter) | 8. Direction Locking Handle |
| 4. + Button (increase parameters/downward) | 9. Bracket Locking Knob |
| 5. Menu Button (enter menu/return to previous interface) | |

What's Inside

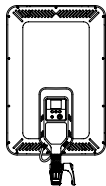

Light Body
× 1



LED Video Baby Stand 1.9M (BS-3R-FE-190)
× 1



Instruction Manual
× 1

Note: Due to continuous updates and upgrades of the products, there may be differences between the actual products and the pictures. Therefore, the pictures are for reference only, products to prevail in kind.

Power On/Off

Connect to power source, toggle the power switch to (|) to turn it on, toggle to (O) to turn it off.

Menu Settings

Press the menu button to enter menu interface, press the <+> or <-> button to choose among the following setting options. Press the SET button to enter a certain setting option, then press the menu button return to previous interface.

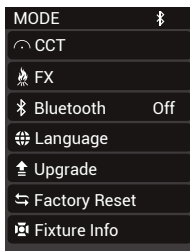

CCT

Press the SET button to enter CCT interface, in which you can adjust the DIM/CCT. Press the <+/-> button when the DIM/CCT box is selected can increase/decrease the parameters, while press and hold can adjust quickly. Then press the SET button to exit the current setting adjustment, and press the <+/-> button to switch to another setting adjustment.

DIM Range: 0% ~ 100%

CCT Range: 2800K ~ 6500K

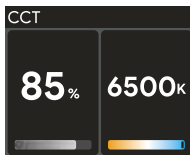

FX

Press the SET button to enter FX interface, in which you can press the <+/-> button and SET button to choose among the following 11 effects and adjust their respective parameters.

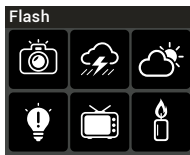

Effect	DIM	CCT	Speed	Others
Flash	0% -100%	2800K-6500K	1-100	Mode: Camera Flash/Flash Bulb Trigger: Auto/Manual
Lightning		2800K-6500K	×	Times: Random/1-10 Frequency: Random /2-20 Trigger: Auto/Manual
Cloudy		×	Random /1-100	Ratio: 30%-90%
Broken Bulb		2800K-6500K	1-100	×
TV		×	1-100	×
Candle		×	1-100	×
Fire		×	1-100	×
Firework		×	1-100	Embers: 1-100
Explosion		2800K-6500K	1-100	Embers: 1-100 Trigger: Auto/Manual
Welding		2800K-6500K	1-100	×
SOS		2800K-6500K	×	×

Note: Please press the <+/- > button to adjust the parameters (press and hold to adjust quickly), then press the SET button to exit the current setting adjustment. Select manual, the effect can be triggered once by pressing the SET button once. After a certain effect is set, press menu button can return to the 11 effects interface.

Bluetooth

Press the SET button to enter Bluetooth interface, press the SET button to choose Bluetooth switch, then press the <+/-> button to turn on/off the Bluetooth. If you need to reset the Bluetooth, choose reset and press the SET button. The MAC code is on the corner for quick check.

"GODOX Light" app Downloading

Scan the QR code to download the "Godox Light" smartphone app (can be used in Android and iOS).

Note:

1. The app can be used directly on the firstly installed device (smartphone or tablet). When change to other mobile device (smartphone or tablet), the light shall be reset before the normal connection of the app.
2. The app should be version 3.0 or above.

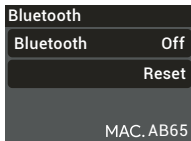

Language

Press the SET button to enter language interface, press the < +/-> button to choose between simplified Chinese and English, then press the SET button to enter.

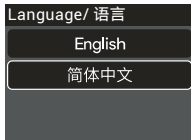

Upgrade

Press the SET button to enter upgrade interface to check the upgrade instruction.

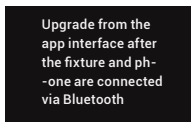

“GODOX Light” app Firmware Upgrade

Open Godox Light, enter a certain scene and click < + > to add a fixture, then click to < : > display more settings, choose firmware upgrade.

Note: If the app upgrade process is unexpectedly interrupted and the device fails to power on, first unplug the power cord. While the device is completely powered off, press and hold the +, -, and SET buttons simultaneously. Then reconnect the power cord and turn on the device. This will allow you to re-enter the Bluetooth upgrade interface and continue to upgrade via the app.

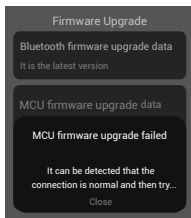

Factory Reset

Press the SET button to enter factory reset interface to choose confirm or cancel. If you choose confirm, the device will automatically reset and reboot, then simplified Chinese and English options show on the display for your choice, after which the brightness will turn to 100% automatically.

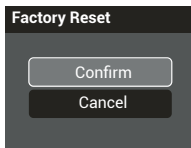

Fixture Info

Press the SET button to enter fixture info interface to check the product basic information.

Illuminance Data

CCT	Testing Condition	Unit	1m	2m	3m
2800K	Bare Light	lux	1450	391	181
		fc	134	36	17
3200K		lux	1720	463	214
		fc	159	43	20
4300K		lux	1860	502	231
		fc	173	47	22
5600K		lux	1930	521	240
		fc	179	48	22
6500K	lux	1700	459	211	
	fc	158	43	20	

Note: All the data are average values instead of absolute values. All the above tests are based on the condition of 100% brightness.

Technical Data

Model	LP800Bi
Input	100V-240V~50/60Hz, 85W
CCT Range	2800K~6500K
DIM Range	0%~100%
FX Modes	11
CRI	≈ 96
TLCI	≈ 98
Controlling Methods	Bluetooth, light body control
Bluetooth Controlling Distance	30m
Working Environment Temperature	-10°C ~ 40°C
Dimension	≈13.5*2.6*24.49"
Net Weight	≈2.3kg

Specifications and data may subject to changes without notice.

FCC Caution

This device complies with part 15 of the FCC Rules. Operation is subject to the following two conditions:

- (1) This device may not cause harmful interference, and
- (2) this device must accept any interference received, including interference that may cause undesired operation.

Any Changes or modifications not expressly approved by the party responsible for compliance could void the user's authority to operate the equipment.

Note: This equipment has been tested and found to comply with the limits for a Class B digital device, pursuant to part 15 of the FCC Rules. These limits are designed to provide reasonable protection against harmful interference in a residential installation.

This equipment generates uses and can radiate radio frequency energy and, if not installed and used in accordance with the instructions, may cause harmful interference to radio communications.

However, there is no guarantee that interference will not occur in a particular installation. If this equipment does cause harmful interference to radio or television reception, which can be determined by turning the equipment off and on, the user is encouraged to try to correct the interference by one or more of the following measures:

- Reorient or relocate the receiving antenna.
- Increase the separation between the equipment and receiver.
- Connect the equipment into an outlet on a circuit different from that to which the receiver is connected.
- Consult the dealer or an experienced radio/TV technician for help.

The device has been evaluated to meet general RF exposure requirement.

The device can be used in portable exposure condition without restriction.

Warning

Operating frequency: 2402MHz – 2480MHz (BT)

Maximum EIRP Power: 5dBm

Declaration of Conformity

GODOX Photo Equipment Co.,Ltd. hereby declares that this equipment are in compliance with the essential requirements and other relevant provisions of Directive 2014/53/EU. In accordance with Article 10(2) and Article 10(10), this product is allowed to be used in all EU member states. For more information of DoC, Please click this web link:

<https://www.godox.com/eu-declaration-of-conformity/>

The device complies with RF specifications when the device used at 0mm from your body.

IC Warning

This device complies with Innovation, Science and Economic Development Canada licence-exempt RSS standard(s). Operation is subject to the following two conditions:

- (1) This device may not cause interference, and
- (2) This device must accept any interference, including interference that may cause undesired operation of the device.

Cet appareil est conforme aux normes RSS exemptées de licence d'Innovation, Sciences et Développement économique Canada. L'exploitation est soumise aux deux conditions suivantes:

- (1) Cet appareil ne peut pas causer d'interférences, et
- (2) Cet appareil doit accepter toute interférence, y compris celles qui pourraient entraîner un fonctionnement accidentel de l'appareil.

Any Changes or modifications not expressly approved by the party responsible for compliance could void the user's authority to operate the equipment.

Tout changement ou modification non expressément approuvé par la partie responsable de la réglementation de l'OCDE peut faire perdre à l'utilisateur le droit d'utiliser l'appareil.

Note: This equipment has been tested and found to comply with the limits for a Class B digital device, pursuant to part 15 of the FCC Rules. These limits are designed to provide reasonable protection against harmful interference in a residential installation. This equipment generates uses and can radiate radio frequency energy and, if not installed and used in accordance with the instructions, may cause harmful interference to radio communications. However, there is no guarantee that interference will not occur in a particular installation. If this equipment does cause harmful interference to radio or television reception, which can be determined by turning the equipment off and on, the user is encouraged to try to correct the interference by one or more of the following measures:

- Reorient or relocate the receiving antenna.
- Increase the separation between the equipment and receiver.
- Connect the equipment into an outlet on a circuit different from that to which the receiver is connected.
- Consult the dealer or an experienced radio/TV technician for help.

Remarque: cet appareil a été testé pour répondre aux limites des appareils numériques de classe B conformément à la partie 15 des règles de la Federal Communications Commission des États-Unis. Ces limites sont conçues pour fournir une protection raisonnable contre les interférences nuisibles dans les installations résidentielles. L'appareil génère de l'énergie RF utilisée et rayonne, ce qui peut causer des interférences nocives pour les communications radio s'il n'est pas installé et utilisé conformément aux instructions. Cependant, aucune Garantie contre les interférences dans une installation spécifique. Si l'appareil cause des interférences nuisibles à la réception de la radio ou de la télévision, qui peuvent être déterminées en éteignant et en allumant l'appareil, l'utilisateur est encouragé à tenter de corriger les interférences par une ou plusieurs des mesures suivantes:

- redirection ou repositionnement de l'antenne de réception.
- augmenter l'espacement entre l'appareil et le récepteur.
- Connecter l'appareil à une prise sur un circuit différent de celui auquel le récepteur est connecté.
- consultez votre revendeur ou un technicien radio / tv expérimenté pour obtenir de l'aide.

RF warning for Portable device:

The device has been evaluated to meet general RF exposure requirement. The device can be used in portable exposure condition without restriction.

Avertissement RF pour les appareils portables:

L'appareil a été évalué pour répondre aux exigences générales d'exposition aux radiofréquences. L'équipement Peut être utilisé sans restriction dans des conditions d'exposition portables.

产品保修

尊敬的用户，本保修卡是申请保修服务的重要凭证，请您配合销售商填写并妥善保管，谢谢！

产品信息	型号	产品条形码
用户信息	姓名	联系电话
	通信地址	
销售商信息	名称	
	联系电话	
	通信地址	
	销售日期	
备注		

注：此表应由销售商盖章确认。

适用产品

本文件适用于相关《产品保修信息》(见后面说明)所列产品,其他非属此范围的产品或部件(如促销品、赠品及其他出厂后附加的部件等)不在此保修承诺内。

保修期

产品及部件的相应保修期按相关的《产品保修信息》执行。保修期自产品首次购买日起算，购买日以购买产品时保修卡登记日期为准。

如何获得保修服务

您可直接与产品销售商或授权服务机构联系，也可拨打神牛产品售后服务电话，与我们联系，由我们的服务人员为您安排服务。申请保修时，您应提供有效的保修卡作为保修凭证，方可获得保修。如您不能提供有效的保修卡，则在我们确认产品或部件属于保修范围的情况下，也可以为您提供保修，但这不作为我们的义务。

不适用保修情况

如产品存在下列情况，本文件项下的保证和服务将不适用：①产品或部件超过相应保修期；②错误或不当使用、维护或保管导致的故障或损坏，如：不当搬运；非按产品合理预期用途使用；不当插拔外接设备；跌落或外力挤压；接触或暴露于不适当温度、溶剂、酸碱、水浸或潮湿环境；③由非神牛授权机构或人员安装、修理、更改、添加或拆卸造成的故障或损坏；④产品或部件原有识别信息被修改变更或删除；⑤无有效保修卡；⑥使用非合法授权、非标准或非公开发行的软件造成的故障或损坏；⑦因不可抗力或意外事件造成的故障或损坏；⑧其他非因产品本身质量问题导致的故障或损坏。遇上述情况，您应向相关责任方寻求解决，神牛对此不承担任何责任。因非在保修期或保修范围内的部件、附件或软件导致产品不能正常使用的，不是保修范围内的故障。产品使用过程中正常的脱色，磨损和消耗，不是保修范围内的故障。

产品保修和服务支持信息

产品的保修期和服务类型按以下《产品保修信息》执行：

部件	保修期（月）	保修服务类型
内部电路板	12	客户送修
其他（例如光效附件、各类线材或其他包装）	无	无保修

神牛产品售后服务电话 0755-29609320-8062

Warranty

Dear customers, as this warranty card is an important certificate to apply for our maintenance service, please fill in the following form in coordination with the seller and safe-keep it. Thank you!

Product Information	Model	Product Code Number
	Name	Contact Number
Customer Information	Address	
	Name	
Seller Information	Contact Number	
	Address	
	Date of Sale	
	Note	

Note: This form shall be sealed by the seller.

Applicable Products

Applicable ProductsThe document applies to the products listed on the Product Maintenance Information (see below for further information). Other products or accessories (e.g. promotional items,giveaways and additional accessories attached,etc.) are not included in this warranty scope.

Warranty Period

The warranty period of products and accessories isimplemented according to the relevant Product Maintenance Information. The warranty period is calculated from the day(purchase date) when the product is bought for the first time,And the purchase date is considered as the date registered onthe warranty card when buying the product.

How to Get the Maintenance Service

If maintenance service is needed, you can directly contact the product distributor or authorized service institutions. You can also contact the Godox after-sale service call and we will offer you service. When applying for maintenance service, you should provide valid warranty card. If you cannot provide valid warranty card, we may offer you maintenance service once confirmed that the product or accessory is involved in the maintenance scope, but that shall not be considered as our obligation.

Inapplicable Cases

The guarantee and service offered by this document are not applicable in the following cases:

① The product or accessory has expired its warranty period; ② Breakage or damage caused by inappropriate usage, maintenance or preservation, such as improper packing, improper usage, improper plugging in/out external equipment, falling off or squeezing by external force, contacting or exposing to the improper temperature, solvent, acid, base, flooding and damp environments, etc; ③ Breakage or damage caused by non-authorized institution or staff in the process of installation, maintenance, alternation, addition and detachment; ④ The original identifying information of product or accessory is modified, alternated, or removed; ⑤ No valid warranty card; ⑥ Breakage or damage caused by using illegally authorized, nonstandard or non-public released software; ⑦ Breakage or damage caused by force majeure or accident; ⑧ Breakage or damage that could not be attributed to the product itself. Once met these situations above, you should seek solutions from the related responsible parties and Godox assumes no responsibility. The damage caused by parts, accessories and software that beyond the warranty period or scope is not included in our maintenance scope. The normal discoloration, abrasion and consumption are not the breakage within the maintenance scope.

Maintenance and Service Support Information

The warranty period and service types of products are implemented according to the following Product Maintenance Information:

Parts	Maintenance Period (month)	Warranty Service Type
Internal circuit board	12	Customer sends the product to designated site
Other Items (optical accessories, cables, package, etc)	No	Without warranty

Godox After-sale Service Call +86-755-29609320-8062



Wechat
Official Account
神牛微信公众号

深圳市神牛摄影器材有限公司

地址: 深圳市宝安区福海街道塘尾社区耀川工业园厂房 2 栋
电话: 0755-29609320 (8062) 传真: 0755-25723423 邮箱: godox@godox.com

GODOX Photo Equipment Co., Ltd.

Add.: Building 2, Yaochuan Industrial Zone, Tangwei Community, Fuhai Street, Bao'an District, Shenzhen
518103, China Tel: +86-755-29609320(8062) Fax: +86-755-25723423 E-mail: godox@godox.com

www.godox.com

Made in China | 705-LP80B0-00

