

Godox

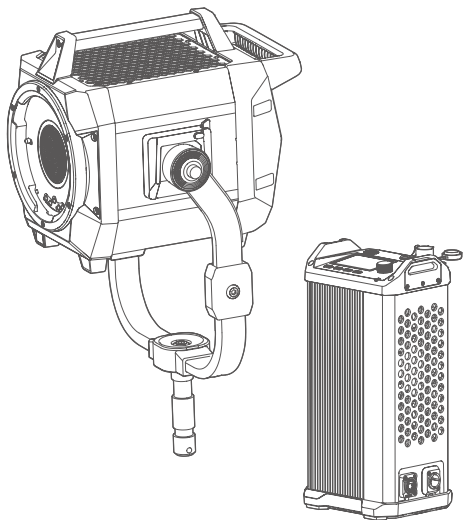

KNOWLED MG1200R

诺力全彩 LED 影视灯
KNOWLED Full-color LED Light

使用手册
Instruction Manual

V1.2 说明书/Instruction Manual

V1.00 固件/Firmware

重要的安全说明及注意事项

首先作为最基本原则：本产品为专业灯光布景设备，应由专业灯光师使用或在专业人士指导下使用。使用时必须始终遵循基本的安全预防措施，具体安全预防措施如下：

1. 使用前必须阅读并理解产品说明书。
2. 专业灯具，禁止儿童使用。当儿童靠近时，家长或陪护人必须密切监督，以免儿童因碰撞灯具或私用灯具造成人身伤害。
3. 本灯具并非普通照明灯具，不可用于普通照明，任何有过眼部损伤或眼部敏感的人群均应避免使用本灯具。
4. 灯具点亮时，必须小心使用，禁止接触高温部件，如 LED 灯珠，以免造成灼伤。
5. 灯具点亮时，任何情况下均禁止直视灯珠。应该在专业灯光师指导下使用强光，任何情况下避免长时间处于强光环境，如引起眼睛不适，请及时关闭灯具，暂停使用，请及时就医。
6. 倘灯珠损坏或因热变形，应停止使用，并及时联系制造商、服务代理商或合格的维修人员更换灯珠，以免发生意外。
7. 本产品仅适用于 -20°C ~ 45°C 工作温度环境下使用。
8. 请勿使用损坏的设备或设备配件，待专业维修人员检查维修，确认设备正常方可使用。
9. 在使用过程中，如果本产品由于跌落、受到挤压或遭受强烈冲击而造成外壳破裂的，请勿继续使用，以免因接触到内部电子元件而受到电击伤害。
10. 如需要延长线，请使用额定电流 \geq 该设备额定电流的延长线。如延长线额定电流小于该设备，可能导致过热。
11. 部分产品电源线较长，请合理放置电源线，使其处于安全位置。避免电源线接触过热物体表面、避免放置不当导致拉扯损坏或绊倒现场人员。请使用本厂原装电源线，如使用非本厂电源线导致产品损坏，概不在本厂维修范围内。
12. 在清洁和维修之前，请务必从电源插座上拔下该设备插头。不使用时，禁止拉扯电源线以将设备插头从电源插座中拔出。正常断电，应是用手抓住该设备插头两端，将插头从电源插座中拔出。此设备需连接到接地插座中。
13. 请勿私自拆卸产品，如产品出现故障，须由本公司或授权的维修人员进行检查维修。
14. 存放本设备之前，请确保设备已完全冷却。存放时，将电源线从设备上拔出。设备应放置于设备便携包内或通风干燥处。
15. 请勿将设备放置在酒精、汽油等易燃挥发的溶剂附近。
16. 本厂不推荐的产品附件，请勿使用，以免导致火灾、触电或人身伤害。
17. 清洁本设备时，请勿用湿布擦拭，请用干布，软布擦拭设备污垢。
18. 设备使用前，请注意将保护罩取下。
19. 本产品已通过 ROHS, CE 和 FCC 认证，请参考相关国家标准使用和操作。
20. 安全说明依据本厂严格测试制定，设备设计和规格如有变更，恕不另行通知。客户可以

上神牛官网查看最新的电子版说明，了解产品最新资讯。

21. 部分产品内置锂电池。此类产品请使用专用的充电器进行充电，并且按正确的操作说明，在规定的电压、温度范围内使用。
22. 部分产品使用电池供电。此类产品请勿使用说明书中未指定的任何电池、电源或附件。请将电池和其他附件置于儿童及婴幼儿无法触及之处。如果儿童或婴幼儿吞下电池或附件，请立即就医。如果电池漏液、变色、变形、冒烟或发出异味，请立即将其取出。在取出过程中请小心，以免烫伤。如果继续使用，可能会引起火灾、触电或皮肤烫伤。请勿使用任何变形或改造过的电池。请勿拆卸或改造本产品或电池。请勿加热电池或焊接电池。请勿让电池与火或水接触。请勿让电池受到强烈的外力撞击。请勿将电池的正负端错误插入，或将新旧电池或不同类型的电池混合使用。
23. 一年保修期，消耗品电池、适配器、电源线等配件不在此保修范围内。
24. 经发现，擅自检修设备，将取消一年保修期，维修需要收取相关费用。
25. 对于不规范操作引起的机器故障不在保修范围内。

保存这些说明



请勿直视光源

本设备包含型号核准代码为 :CMIIT ID: 24J44811A009，为该产品的无线电发射模块。

前言

感谢您购买神牛产品。

神牛全新推出全彩 LED 影视灯 MG1200R，强劲功率，输入高达 1600W，最高输出可达 1500W；支持 100V-240V 供电，可在全球范围内使用；全彩 RGBW 模式可让不同光色随着主题变化而打造相应氛围，拥有超高亮度、灯体与控制器分离、千分级亮度调节、IP54 级防水防尘、4 种调光曲线、1800K-10000K 色温、多种无线控制等诸多特性；适用于大型摄影棚、影视基地、演播室、户外外景、大型实地场等拍摄场景。

主要特点

- 4 种调光曲线：线性、S 曲线、指数、对数。
- 1500W 超强输出功率，真正的千分级调节，能从 100%完美平滑调光至 0%。
- 宽广色温，调节范围：1800K-10000K。
- 多种智能控制方式，DMX512 控台控制 / LumenRadio CRMX 控制 / 蓝牙 APP 控制 / 以太网控制，支持 Art -Net & sACN 协议。
- 全新神牛 G 卡口，通信触点，智能识别附件，大大提高了使用大功率灯具的安全系数。
- 灯头及控制器均有 IP54 级防护设计，防止粉尘进入的同时，防止各方向飞溅而来的水侵入。
- 采用高效散热大风扇，配合全新散热设计，满足了大灯具散热需求。
- 14 类 FX 光效模式：闪光灯 / 雷电 / 多云 / 坏灯泡 / 电视机 / 蜡烛 / 火 / 烟花 / 爆炸 / 焊接 / 警车 / SOS / 彩光循环 / 派对。

▲ 警告

- ▲ 大功率 LED 灯具，严禁直视光源或照射他人眼睛。
- ▲ 严禁通电时插拔电源线或连接线，以免造成人身伤害。
- ▲ 本灯具工作时，请勿遮挡散热口。
- ▲ 请勿让儿童靠近、接触或使用本灯具。
- ▲ 专业灯光设备，请务必按照使用手册正确操作。
- ▲ 请务必经常清洁灯珠玻璃并使其保持干净，玻璃如粘上蚊虫尸体或深色有机物污渍，可能引起玻璃炸裂。

部件名称

灯体

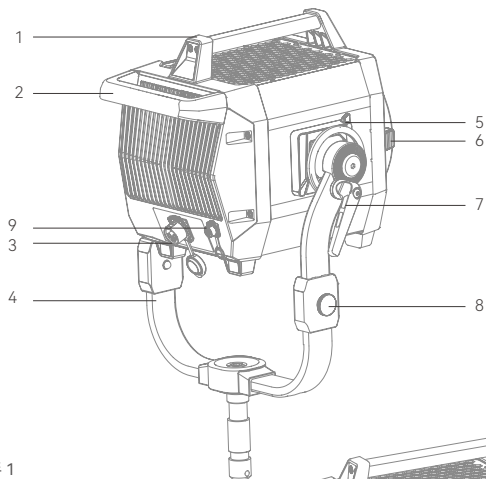

1. 提手 1
2. 提手 2
3. DC 输入接口
4. U 型支架
5. 快装装置
6. 卡口推制
7. 方向调节把手
8. 挂线装置
9. ACC 接口
10. 神牛 G 卡口

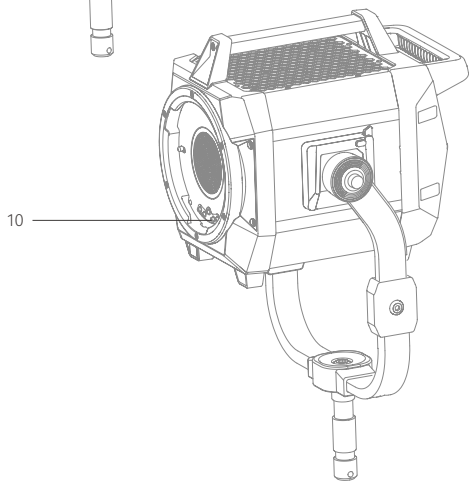

控制器

1. 开关按钮
2. 离机遥控器接口
3. DC 输出接口
4. 彩屏
5. PRESET 按钮
6. LOCK 按钮
7. MENU 按钮
8. MODE 按钮
9. 调节旋钮
10. LED 状态灯
11. DMX OUT 接口
12. DMX IN 接口
13. USB-A 接口
14. 以太网接口
15. AC 输入接口

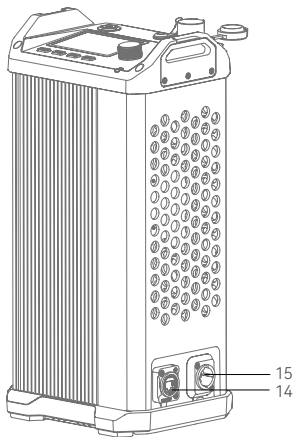
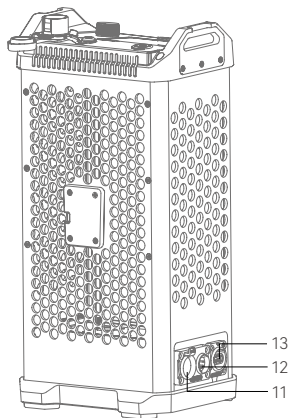
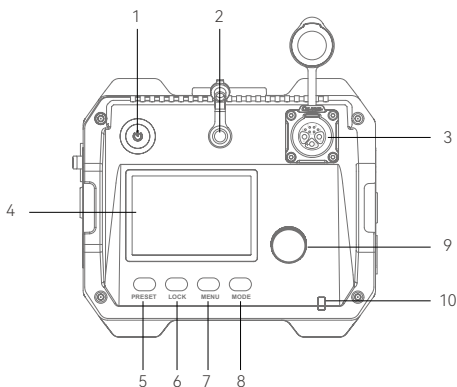

MG1200R 物料清单

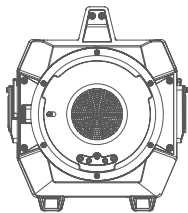

灯体 ×1

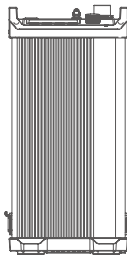

控制器 ×1



保护盖 ×1

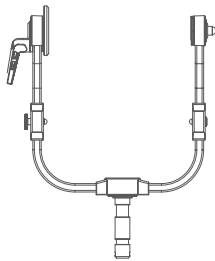

U架 ×1

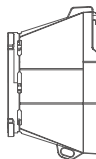

反光罩 GR45 ×1

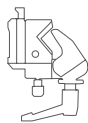

控制器固定件 ×1



说明书 ×1



DMX 模式表 ×1



绑绳 ×1



安全绳 ×1



直流电源线 ×1



交流电源线 ×1

MG1200R K1 物料清单

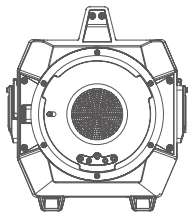

灯体 ×1

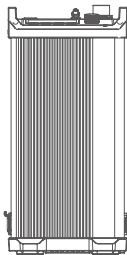

控制器 ×1



保护盖 ×1

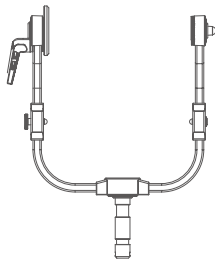

U 架 ×1

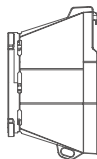

反光罩 GR45 ×1

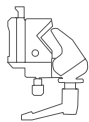

控制器固定件 ×1



说明书 ×1



DMX 模式表 ×1



绑线绳 ×1



安全绳 ×1



直流电源线 ×1



交流电源线 ×1



收纳包 ×1

MG1200R K2 物料清单

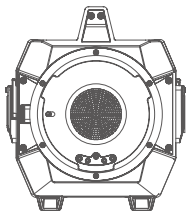

灯体 ×1

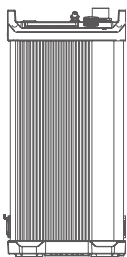

控制器 ×1



保护盖 ×1

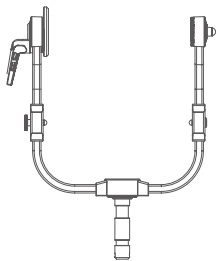

U架 ×1

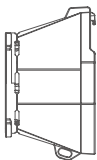

反光罩 GR45 ×1

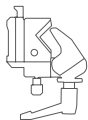

控制器固定件 ×1



说明书 ×1



DMX 模式表 ×1



绑线绳 ×1



安全绳 ×1



直流电源线 ×1



交流电源线 ×1

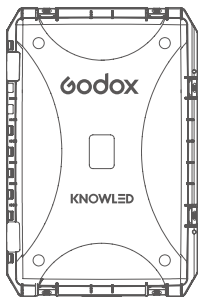

收纳箱 ×1

MG1200R K3 物料清单

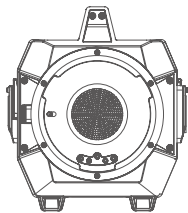

灯体 ×1

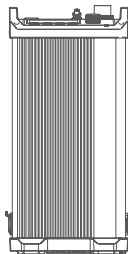

控制器 ×1



保护盖 ×1

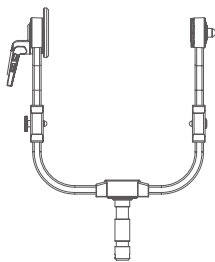

U 架 ×1

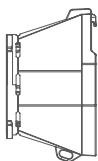

反光罩 GR45 ×1

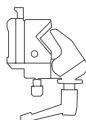

控制器固定件 ×1



说明书 ×1



DMX 模式表 ×1



绑绳绳 ×1



安全绳 ×1



直流电源线 ×1



交流电源线 ×1



航空箱 ×1

温馨提示：说明书中线图均为示意图，仅供参考。由于产品不断更新与升级，产品实物与线图可能存在差异，请以实物为准。

可另购附件

反光罩 GR15、反光罩 GR30、反光罩 GR60、菲涅尔镜头 GF14

安装与拆卸

1. 安装 U 型支架

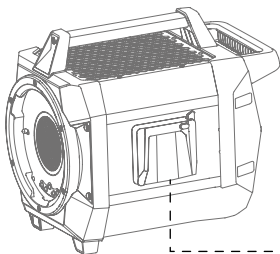

1.1 将灯具放于平面上，散热面朝上。

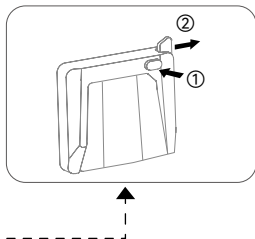

1.2 按住快装装置按钮，拨开扳手。

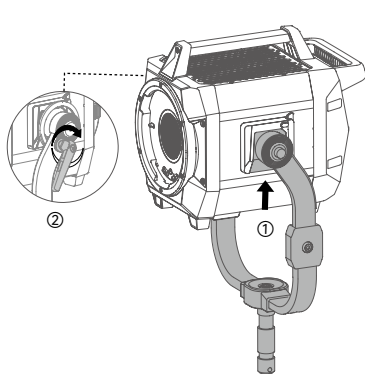

1.3 将 U 型支架两端对准快装装置插入，接着将两边扳手锁紧，听到“咔”一声即表示安装完毕。

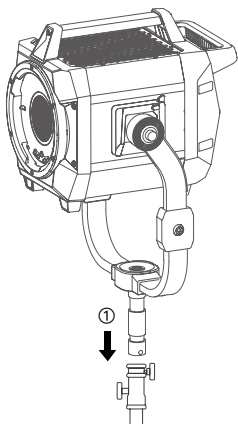

1.4 将灯具安装在滚轮灯架上，锁紧滚轮灯架的固定旋钮。

注：滚轮灯架不包含在标配内，需另购。

⚠ 该灯具重量大，安装需小心谨慎，以免造成人身伤害。

2. 拆卸 U 型支架

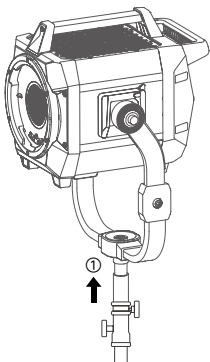

2.1 握住灯具的 U 型架，将灯具从滚轮灯架上取下来放在平面上。

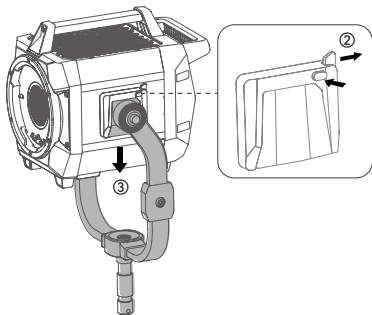

2.2 按住快装装置按钮，拨开扳手，即可将 U 型支架取出。

3. 安装 / 拆卸灯头保护罩

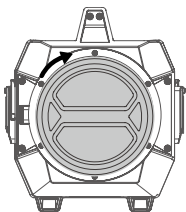

3.1 将灯头保护罩对准灯头卡口，顺时针旋转即可安装完毕。

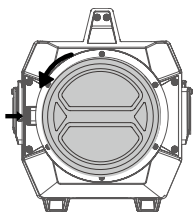

3.2 按住卡口推制，逆时针旋转即可取下灯头保护罩。

4. 安装 / 拆卸反光罩

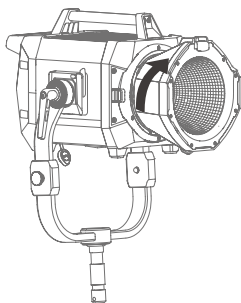

4.1 将反光罩对准灯头卡口插入后顺时针旋转即可安装完毕。

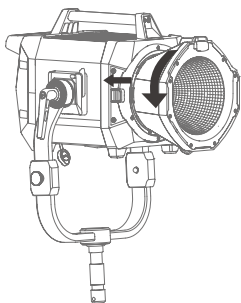

4.2 按住卡口推制，逆时针旋转即可取下灯头反光罩。

5. 将控制器安装到灯架上

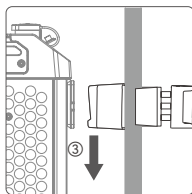
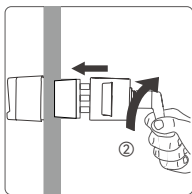

将控制器固定件把手拧松后插入灯架杆，顺时针旋转把手锁定固定件，最后将控制器快装装置对准固定件卡槽插入即可。

6. 连接 DMX 512 控制台

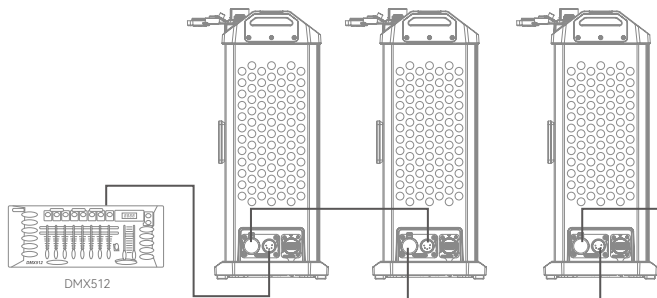

注：仅展示连接 DMX 512 控制台方式，控制台需另购。

供电

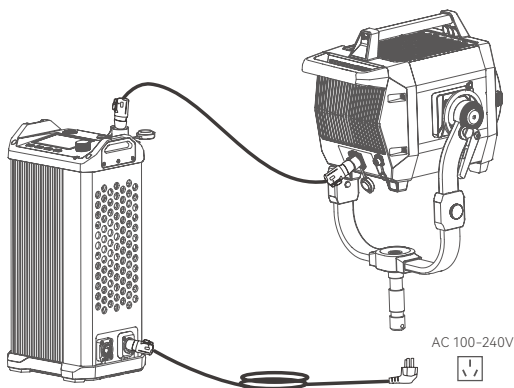

⚠ 严禁通电时插拔电源线或连接线，以免造成意外。

开关机

接通电源，短按控制器开关按键，实现开机或关机。

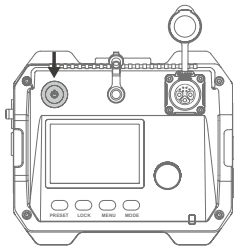

模式界面

旋转调节旋钮可任意选择图示中的 6 种模式，选中其中一个模式，短按调节旋钮可进入该模式进行具体设置。

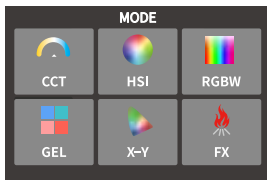

CCT 模式

短按 MODE 按键进入模式选择，选中 CCT 后短按调节旋钮进入该模式，可选亮度 / 色温 / 绿品 GM。通过短按并旋转调节旋钮设置参数值，顺时针旋转递增参数值，逆时针旋转递减参数值。

亮度范围: 0% ~ 100%

色温范围: 1800K ~ 10000K

GM 范围: -100% ~ +100%

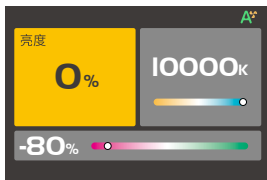

HSI 模式

短按 MODE 按键进入模式选择, 选中 HSI 后短按调节旋钮进入该模式, 可选亮度 / 色相 / 饱和度。通过短按并旋转调节旋钮设置参数值, 顺时针旋转递增参数值, 逆时针旋转递减参数值。

亮度范围: 0% ~ 100%

色相范围: 0° ~ 360°

饱和度范围: 0% ~ 100%



RGBW 模式

短按 MODE 按键进入模式选择, 选中 RGBW 后短按调节旋钮进入该模式, 可选亮度 / 红光 / 绿光 / 蓝光 / 白光。通过短按并旋转调节旋钮设置参数值, 顺时针旋转递增参数值, 逆时针旋转递减参数值。

亮度范围: 0% ~ 100%

红光范围: 0% ~ 100%

绿光范围: 0% ~ 100%

蓝光范围: 0% ~ 100%

白光范围: 0% ~ 100%

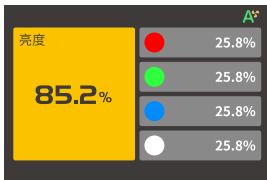

GEL 模式

短按 MODE 按键进入模式选择, 选中 GEL 后短按调节旋钮进入该模式, 可选亮度 / 色片类型 / 色片组类型 / 颜色选择 / 色温 / 色相 / 饱和度。通过短按并旋转调节旋钮设置参数值, 顺时针旋转递增参数值, 逆时针旋转递减参数值。

亮度范围: 0% ~ 100%

色片类型: R-GEL / L-GEL



色片组类型 (R-GEL)

COR. / CAL. / SPC. / CINE.

色片组类型 (L-GEL)

COR. / COLOR. / 600 / COS. / 700

色温: 3200K 或 5600K

色相范围: -10° ~ 10°

饱和度范围: -20% ~ 20%

X-Y 模式

短按 MODE 按键进入模式选择, 选中 XY 后短按调节旋钮进入该模式, 可选亮度调节 / X 坐标调节 / Y 坐标调节 / 颜色温度或颜色空间。

亮度范围: 0% ~ 100%

X 坐标: 0.0000 ~ 0.8500

Y 坐标: 0.0000 ~ 0.8500

颜色温度或颜色空间: Gamut, Rec.2020, DCI-P3, Rec.709, Black body

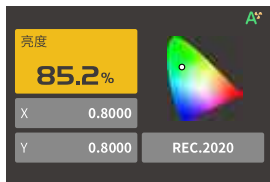

FX 模式

短按 MODE 按键进入模式选择，选中 FX 后短按调节旋钮进入该模式，可选光效有 14 类：闪光灯 / 雷闪电 / 多云 / 坏灯泡 / 电视机 / 蜡烛 / 火 / 烟花 / 爆炸 / 焊接 / 警车 / SOS / 彩光循环 / 派对。通过短按并旋转调节旋钮设置某个光效的参数值，顺时针旋转递增参数值，逆时针旋转递减参数值。

1. 闪光灯

此光效模拟闪光灯闪光或传统镁光灯闪光，常用于营造一种生动、活泼的氛围。

亮度: 0% -100% (以 0.1%为增量)

开关: 开启 / 关闭

颜色: CCT/HSI

色温 / 色相: 1800K-10000K/0-360°

触发: 自动 / 手动

速度: 1-100

模式: 闪光灯 / 镁光灯

2. 雷闪电

此光效模拟雷电的闪电，常用于营造一种紧张、恐怖或神秘的氛围。

亮度: 0% -100% (以 0.1%为增量)

开关: 开启 / 关闭

色温: 1800K-10000K

触发: 自动 / 手动

闪烁次数: 随机 / 1-10

频率: 随机 / 2-20

3. 多云

此光效模拟云层遮挡效果，常用于营造一种阴沉、压抑或悲伤氛围。

亮度: 0% -100% (以 0.1%为增量)

开关: 开启 / 关闭

亮暗比例: 30%-90%

速度: 随机 / 1-100

4. 坏灯泡

此光效模拟一盏损坏的灯泡闪光，常用于营造昏黄的环境氛围。

亮度: 0% -100% (以 0.1%为增量)

开关: 开启 / 关闭

颜色: CCT/HSI

色温 / 色相: 1800K-10000K/0-360°

速度: 1-100

5. 电视机

此光效模拟电视机或屏幕的光线效果，常用于营造出一种冷淡、机械或数字化的氛围。

亮度: 0% -100% (以 0.1%为增量)

开关: 开启 / 关闭

颜色: CCT/HSI

速度: 1-100

6. 蜡烛

此光效模拟蜡烛的光线效果，常用于营造出一种柔和、温暖、闪烁的氛围。

亮度: 0% -100% (以 0.1%为增量)

开关: 开启 / 关闭

速度: 1-100

7. 火

此光效模拟火焰的光线效果，常用于营造出一种明亮、热烈、闪烁氛围。

亮度: 0% -100% (以 0.1%为增量)

开关: 开启 / 关闭

速度: 1-100

8. 烟花

此光效模拟烟花的光线效果，常用于营造出一种绚丽、多彩、浪漫的氛围。

亮度: 0% -100% (以 0.1%为增量)

开关: 开启 / 关闭

余烬: 1-100

速度: 1-100

9. 爆炸

此光效模拟爆炸的光线效果，常用于营造出一种明亮、猛烈、闪烁氛围。

亮度: 0% -100% (以 0.1%为增量)

开关: 开启 / 关闭

颜色: CCT/HSI

色温 / 色相: 1800K-10000K/0-360°

触发: 自动 / 手动

余烬: 1-100

速度: 1-100

10. 焊接

此光效模拟焊接的光线效果，常用于营造出一种炽热、机械的氛围。

亮度: 0% -100% (以 0.1%为增量)

开关: 开启 / 关闭

颜色: CCT/HSI

色温 / 色相: 1800K-10000K/0-360°

速度: 1-100

11. 警车

此光效模拟警车灯光的闪烁效果，常用于营造紧张、追逐或紧张氛围。

亮度: 0% -100% (以 0.1%为增量)

开关: 开启 / 关闭

颜色: 红 + 蓝、红、蓝、蓝 + 白、蓝 + 黄、黄、红 + 白 + 蓝、红 + 黄 + 蓝

模式: 1-5

12.SOS SOS

此光效模拟 SOS 求救信号的闪烁效果，常用于营造危险、求救或紧急情况氛围。

亮度: 0% -100% (以 0.1%为增量)

开关: 开启 / 关闭

颜色: CCT/HSI

色温 / 色相: 1800K-10000K/0-360°

13. 彩光循环

此光效模拟模拟彩色光线的循环和变化效果，常用于营造一种梦幻、科幻的氛围。

亮度: 0% -100% (以 0.1%为增量)

开关: 开启 / 关闭

饱和度: 0%-100%

速度: 1-100

14. 派对

此光效模拟彩色光线、闪光灯和激光等效果，常用于营造出一种狂欢、欢乐、高能氛围。

亮度: 0% -100% (以 0.1%为增量)

开关: 开启 / 关闭

饱和度: 0%-100%

速度: 1-100

注: 根据需求旋转调节旋钮设置当前参数值, 设置完毕后短按并旋转调节旋钮可跳入下一栏参数进行设置; 选中手动时, 通过短按一次调节旋钮触发一次该光效; 某个光效设置完毕后短按 MODE 按键回到 14 类光效选择界面。

菜单设置

短按 MENU 按键进入菜单设置, 旋转调节旋钮选择图示中任意一项, 短按调节旋钮进入该项的具体设置。



1.DMX

短按调节旋钮进入 DMX 设置界面。旋转调节旋钮选择地址 /DMX 模式 /RDM 状态 /DMX 丢失状态 / 终止开关 / 增强通道。短按调节旋钮进入选项设置, 通过旋转调节旋钮完成选项设置。选项设置完毕, 短按调节按钮可退出选项设置, 短按 MENU 按键返回上一级。



一级选项	二级选项	说明
地址	001-512	起始地址
DMX模式	01: CCT 8 Bit	8位CCT模式
	02: HSI 8 Bit	8位HSI模式
	03: RGB 8 Bit	8位RGB模式
	04: RGBW 8 Bit	8位RGBW模式
	05: CCT+HSI 8 Bit	8位CCT+HSI模式
	06: CCT+RGBW 8 Bit	8位CCT+RGBW模式
	07: FX 8 Bit	8位FX模式
	08: GEL 8 Bit	8位GEL模式
	09: CCT 16 Bit	16位CCT模式
	10: HSI 16 Bit	16位HSI模式
	11: RGB 16 Bit	16位RGB模式
	12: RGBW 16 Bit	16位RGBW模式
	13: X-Y 16 Bit	16位X-Y模式
	14: FX 16 Bit	16位FX模式
	15: GEL 16 Bit	16位GEL模式
RDM状态	开启	开启RDM, 开启后控制台可设置灯具地址及DMX模式
	关闭	关闭RDM
DMX丢失状态	保持最后状态	失去DMX控制信号后, 在关机或再次接收有效DMX控制信号前, 持续使用最后一次接收的DMX控制信号
	直接关闭	灯具直接熄灭
	保持最后状态2分钟熄灭	失去DMX控制信号后, 持续使用最后一次接收的DMX控制信号2分钟, 2分钟后灯具熄灭。注: 如2分钟内接收到有效DMX控制信号, 则使用新的DMX控制信号。
终止开关	开启	开启DMX终端
	关闭	关闭DMX终端
DMX增强通道	开启	开启增强通道信号
	关闭	关闭增强通道信号

注: 使用 DMX/RDM 控制台控制灯具, 可参照附件《MG1200R DMX 模式表》。

电子版可登录官网 <https://www.godox.com.cn> 下载。

2. CRMX

短按调节旋钮进入 CRMX 设置界面。旋转调节旋钮选择 CRMX 开关 / 模式。短按调节旋钮进入选项设置，通过旋转调节旋钮完成选项设置。选项设置完毕，短按调节按钮可退出选项设置，短按 MENU 按键返回上一级。

注：选择发射模式 / 接收模式前，先进行复位。



CRMX 发射模式界面



CRMX 接收模式界面

一级选项	二级选项	说明
CRMX	开启	开启CRMX
	关闭	关闭CRMX
模式	发射模式	CRMX开启发射模式
	接受模式	CRMX开启接收模式
发射功率	5dBm	仅发射模式下可调，发射功率值为5dBm
	11dBm	仅发射模式下可调，发射功率值为11dBm
	16dBm	仅发射模式下可调，发射功率值为16dBm
	20dBm	仅发射模式下可调，发射功率值为20dBm
重置	复位	恢复初始设置

扫描二维码即可下载“Godox KNOWLED”app



3. 蓝牙

短按调节旋钮进入蓝牙设置界面。旋转调节旋钮选择蓝牙开关 / 蓝牙重置，短按调节旋钮进入设置，通过旋转调节旋钮完成设置。设置完毕，短按 MENU 按键返回上一级。



扫描二维码即可下载“Godox Light”手机 app
(安卓和苹果系统都可以使用)。



注: 首个移动设备(手机或平板电脑)可直接使用 APP 操控灯体。更换其他移动设备时, 灯体需进行蓝牙重置方可正常使用 APP。

注: APP 需升级至 V3.0 以上版本。

4. 以太网

短按调节旋钮进入以太网设置界面。旋转调节旋钮至网络模式, 短按调节旋钮进入网络模式设置界面, 旋转调节旋钮选择 DHCP/Art-Net 2.x/Art-Net 10.x/ 手动。设置完毕, 短按 MENU 按键返回上一级。



一级选项	二级选项	说明
网络模式	DHCP	使用DHCP模式
	Art-Net 2.x	使用2.B.C.D网络
	Art-Net 10.x	使用10.B.C.D网络
	手动	可手动设置网络IP、子网掩码、默认网关
IP	AAA.BBB.CCC.DDD	如果启动DHCP模式, 灯光ID地址则为DHCP分配。 如果启动Art-Net 2.x模式, 灯光ID地址则为2.B.C.D。 如果Art-Net 10.x模式, 灯光ID地址则为10.B.C.D。 如果启动手动模式, AAA=0-255 BBB=0-255 CCC=0-255 DDD=0-255
子网掩码	255.BBB.CCC.DDD	如果启动DHCP/Art-Net 2.x/Art-Net 10.x, 子网掩码为255.BBB.CCC.DDD不能通过菜单更改。 如果启动手动, AAA=0-255 BBB=0-255 CCC=0-255 DDD=0-255
默认网关	AAA.BBB.CCC.DDD	如果启动DHCP模式, 灯光默认网关则为DHCP分配。 如果启动Art-Net 2.x模式, 灯光默认网关址则为2.B.C.D。 如果Art-Net 10.x模式, 灯光默认网关则为10.B.C.D。 如果启动手动模式, AAA=0-255 BBB=0-255 CCC=0-255 DDD=0-255

5. Art-Net&sACN

短按调节旋钮进入 Art-Net & sACN 协议设置。
短按并旋转调节旋钮设置参数值,如下表所示。

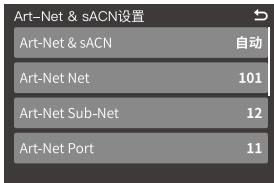

一级选项	二级选项	说明
Art-Net&sACN	自动/Art-Net/sACN/关	自动: 接受Art-Net&sACN两种协议。 Art-Net: 只接受Art-Net协议。 sACN: 只接受sACN协议。 关: 不接受网络协议。
Art-Net Net	0-127	选择Art-Net网络
Art-Net Sub-Net	0-15	在Art-Net网络中选择Art-Net子网
Art-Net Port	0-15	Art-Net端口
Art-Net Universe	0...32767	Art-Net域
sACN Universe	1...63999	sACN域

6. 附件识别

短按调节旋钮进入附件识别设置界面。短按调
节旋钮后旋转调节旋钮选择开启 / 关闭。设置
完毕,短按 MENU 按键返回上一级。

注: 附件识别开启后,附件未安装到位,灯具不会亮。

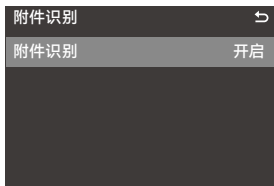

7. 调光曲线

短按调节旋钮进入调光曲线设置。旋转调节旋钮选择线性、S曲线、指数、对数。设置完毕，短按调节旋钮 / 短按 MENU 按键返回上一级。



8. 平滑度

短按调节旋钮进入平滑度设置。旋转调节旋钮选择默认、平滑、平滑关，设置完毕，短按 MENU 按键返回上一级。

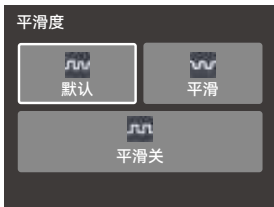

平滑度	备注
默认	亮度数据进行基础平滑处理，实现平滑调光，缩短响应时间
平滑度	亮度数据进行平滑处理，实现超平滑调光，响应时间慢
关闭	未对亮度数据进行平滑处理，响应时间最快

9. 控制模式

短按调节旋钮进入控制模式设置界面。短按调节旋钮后旋转可设置常规 / 低亮 / 高速三种模式，选择完毕短按并旋转调节旋钮可设置常规和低亮模式的频率，范围：1-11。设置完毕，短按 MENU 按键返回上一级。

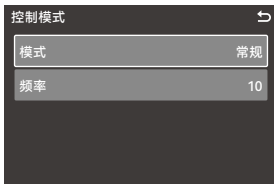

控制模式	适用环境	调光特性	闪烁
常规模式	正常调光	整个调光范围内都很好	不太会出现闪烁
低亮模式	电视 / 电影	低亮度水平时很好	可能出现闪烁
高速模式	不支持调光	/	无闪烁

10. 色域空间

短按调节旋钮进入色域空间设置界面。短按调节旋钮后依次可选原始色域、校色色域、Rec.709、DCI-P3，旋转并短按调节旋钮选定，设置完毕，短按 MENU 按键返回上一级。

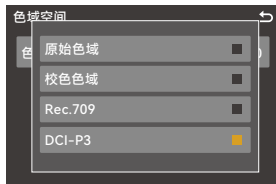

11. 风扇

短按调节旋钮进入风扇设置界面。旋转调节旋钮选择静音、自动、中速、高速模式。选择完毕，短按调节旋钮 / 短按 MENU 按键返回上一级。



12. 屏幕设置

短按调节旋钮进入屏幕设置界面。短按调节旋钮后旋转调节旋钮设置屏幕亮度值，调节范围为 10% -100%。设置完毕，短按 MENU 按键返回上一级。



13. 语言

短按调节旋钮进入语言设置界面。旋转调节旋钮选择简体中文 /English，短按调节旋钮完成设置。设置完毕，短按 MENU 按键返回上一级。

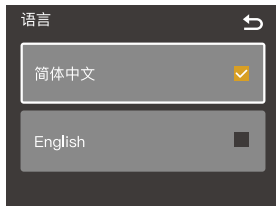

14. 版本与升级

短按调节旋钮进入版本与升级界面, 在此界面可查看灯具固件版本及升级固件提示。查看完毕, 短按 MENU 按键返回上一级。

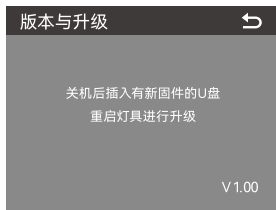

15. 恢复出厂设置

短按调节旋钮进入恢复出厂设置界面。旋转调节旋钮选择确定 / 取消, 短按调节旋钮完成设置。恢复出厂设置, 亮度值自动变为 100% 且重启。



16. 灯具信息

短按调节旋钮进入灯具信息, 在此界面可查看灯具型号、UID 号、固件版本、灯头温度等信息。查看完毕, 短按 MENU 按键返回上一级。



锁定设置

短按 LOCK 按键, 屏幕出现 (🔒) 表示当前界面被锁定; 再次短按 LOCK 按键便可解锁。

注: 此锁定功能仅锁定控制器操控面板, 其他操作方式仍可正常操作。



预存设置

短按 PRESET 按键进入预存灯具光效界面。旋转调节旋钮选择 1-20 组预设,短按调节旋钮进入预设组设置,通过旋转调节旋钮选择保存/取消,最后短按调节旋钮完成设置。设置完毕,短按 MODE 按键回到主界面。

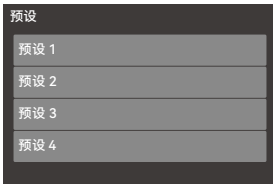

升级详情

1. 在官网 (<https://www.godox.com.cn/firmware-continuous-light>) 下载新固件到 U 盘上。
2. 在关机的状态下,将存有新固件的 U 盘插入 Type-A USB 端口。
3. 开机, MG1200R 影视灯自动进入升级界面。
4. 升级完毕自动跳回主界面。

注: 1. 必须在官网上下载新固件,存放在 U 盘根目录里,而且仅有一个 BIN 文件。
2.Type-A USB 端口支持供电,输出电压电流 5V/1.5A,请勿接入大功率 USB 设备

维护保养

一年保修期,消耗品电池,适配器,电源线等配件不在此保修范围内。

经发现,擅自检修此 LED 影视灯,将取消 LED 影视灯一年保修期,维修需要收取相关费用。

对于不规范操作引起的机器故障不在保修范围内。

所有维修一概由本厂指定的可供原配件的维修部负责。

如本品出现故障或者被水淋湿,在专业人员维修后方可继续使用。LED 影视灯在工作时,如发现异常,应立即关掉电源,查明原因。

照度数据 (常规模式)

色温	测试条件	照度单位	3m	5m	7m	9m
1800K	裸灯	lux	1500	634	380	205
		fc	139	59	35	19
	带反光罩 GR15(15°)	lux	29000	9700	4830	2960
		fc	2690	901	448	275
	带反光罩 GR30(30°)	lux	13000	4470	2340	1450
		fc	1210	415	218	134
	带反光罩 GR45(45°)	lux	6090	2200	1210	796
		fc	566	205	113	74
	带反光罩 GR60(60°)	lux	3450	1340	758	433
		fc	321	124	70	40
菲涅尔镜头 GF14(聚光)	lux	16300	5520	2570	1360	
	fc	1510	513	239	126	
菲涅尔镜头 GF14(泛光)	lux	5400	2080	1130	679	
	fc	502	193	105	63	
2800K	裸灯	lux	5310	2200	1300	771
		fc	493	205	121	72
	带反光罩 GR15(15°)	lux	101000	34200	17200	10500
		fc	9410	3180	1600	979
	带反光罩 GR30(30°)	lux	46100	15700	8250	5160
		fc	4280	1460	766	479
	带反光罩 GR45(45°)	lux	21200	7720	4190	2460
		fc	1970	717	389	228
	带反光罩 GR60(60°)	lux	11900	4630	2620	1740
		fc	1110	430	244	161
菲涅尔镜头 GF14(聚光)	lux	56700	19400	8770	4810	
	fc	5270	1800	814	447	
菲涅尔镜头 GF14(泛光)	lux	19200	7280	3970	2420	
	fc	1780	676	369	225	
3200K	裸灯	lux	5600	2330	1370	850
		fc	520	217	128	79
	带反光罩 GR15(15°)	lux	108000	36300	18100	11100
		fc	10000	3380	1680	1030
	带反光罩 GR30(30°)	lux	49100	16700	8650	5420
		fc	4560	1550	804	503
	带反光罩 GR45(45°)	lux	22600	8220	4430	2840
		fc	2100	764	412	263
	带反光罩 GR60(60°)	lux	12700	4890	2760	1850
		fc	1180	454	256	172
菲涅尔镜头 GF14(聚光)	lux	60600	20400	9310	5120	
	fc	5630	1890	865	476	
菲涅尔镜头 GF14(泛光)	lux	20400	7780	4210	2560	
	fc	1890	723	391	238	

色温	测试条件	照度单位	3m	5m	7m	9m
4300K	裸灯	lux	5440	2280	1340	844
		fc	505	211	124	78
	带反光罩 GR15(15°)	lux	105000	35500	17600	10700
		fc	9750	3300	1640	997
	带反光罩 GR30(30°)	lux	48000	16400	8390	5290
		fc	4460	1520	780	491
	带反光罩 GR45(45°)	lux	22100	8040	4300	2760
		fc	2050	747	400	256
	带反光罩 GR60(60°)	lux	12400	4760	2680	1800
		fc	1150	442	249	167
	菲涅尔镜头 GF14(聚光)	lux	58700	19700	9230	5030
		fc	5460	1830	858	468
菲涅尔镜头 GF14(泛光)	lux	19900	7600	4120	2510	
	fc	1850	706	383	233	
5600K	裸灯	lux	5220	2190	1290	824
		fc	485	203	120	77
	带反光罩 GR15(15°)	lux	101000	34200	16900	10300
		fc	9420	3180	1570	960
	带反光罩 GR30(30°)	lux	46100	15700	8040	5090
		fc	4280	1460	747	473
	带反光罩 GR45(45°)	lux	21300	7710	4150	2720
		fc	1980	716	385	253
	带反光罩 GR60(60°)	lux	12000	4600	2570	1730
		fc	1110	428	239	161
	菲涅尔镜头 GF14(聚光)	lux	56500	18900	8960	4830
		fc	5250	1760	833	449
菲涅尔镜头 GF14(泛光)	lux	19200	7310	3960	2420	
	fc	1780	679	368	225	
6500K	裸灯	lux	5030	2110	1240	799
		fc	467	196	115	74
	带反光罩 GR15(15°)	lux	98100	32800	16300	9970
		fc	9110	3050	1510	926
	带反光罩 GR30(30°)	lux	44500	15200	7730	4910
		fc	4140	1410	718	456
	带反光罩 GR45(45°)	lux	20500	7470	3990	2620
		fc	1910	694	371	243
	带反光罩 GR60(60°)	lux	11600	4430	2480	1660
		fc	1070	411	230	155
	菲涅尔镜头 GF14(聚光)	lux	54500	18100	8650	4670
		fc	5060	1680	804	434
菲涅尔镜头 GF14(泛光)	lux	18500	7040	3830	2330	
	fc	1720	654	356	216	

色温	测试条件	照度单位	3m	5m	7m	9m
8500K	裸灯	lux	4570	1910	1130	728
		fc	424	178	105	68
	带反光罩 GR15(15°)	lux	89400	29900	14800	9040
		fc	8300	2780	1370	840
	带反光罩 GR30(30°)	lux	40400	13800	7010	4450
		fc	3760	1280	651	413
	带反光罩 GR45(45°)	lux	18600	6780	3630	2380
		fc	1730	630	337	221
	带反光罩 GR60(60°)	lux	10500	4020	2260	1510
		fc	977	374	210	140
	菲涅尔镜头 GF14(聚光)	lux	49400	16400	7820	4230
		fc	4590	1530	726	393
菲涅尔镜头 GF14(泛光)	lux	16800	6410	3480	2090	
	fc	1560	595	323	195	
10000K	裸灯	lux	4370	1850	1090	700
		fc	406	172	101	65
	带反光罩 GR15(15°)	lux	85500	28800	14200	8680
		fc	7940	2670	1320	807
	带反光罩 GR30(30°)	lux	38600	13200	6720	4270
		fc	3590	1230	624	396
	带反光罩 GR45(45°)	lux	17900	6520	3480	2290
		fc	1660	606	324	212
	带反光罩 GR60(60°)	lux	10100	3860	2170	1450
		fc	937	359	201	135
	菲涅尔镜头 GF14(聚光)	lux	47500	15800	7510	4070
		fc	4410	1470	698	378
	菲涅尔镜头 GF14(泛光)	lux	16100	6140	3330	2030
		fc	1500	571	310	189

色温	测试条件	照度单位	3m	5m	7m	9m
R(红光)	裸灯	lux	775	329	199	127
		fc	72	31	19	12
	带反光罩 GR15(15°)	lux	14800	4900	2460	1500
		fc	1380	455	229	140
	带反光罩 GR30(30°)	lux	6620	2280	1190	738
		fc	615	212	111	69
	带反光罩 GR45(45°)	lux	3090	1120	621	410
		fc	287	106	58	38
	带反光罩 GR60(60°)	lux	1780	687	395	257
		fc	165	64	38	24
	菲涅尔镜头 GF14(聚光)	lux	8320	2800	1330	696
		fc	773	260	123	65
菲涅尔镜头 GF14(泛光)	lux	2670	1040	576	343	
	fc	248	96	54	32	
G(绿光)	裸灯	lux	1470	621	370	241
		fc	137	58	34	22
	带反光罩 GR15(15°)	lux	29100	9710	4790	2920
		fc	2710	902	445	271
	带反光罩 GR30(30°)	lux	13000	4452	2270	1430
		fc	1200	413	211	133
	带反光罩 GR45(45°)	lux	6030	2200	1180	775
		fc	560	204	110	72
	带反光罩 GR60(60°)	lux	3400	1300	735	492
		fc	316	121	68	46
	菲涅尔镜头 GF14(聚光)	lux	16000	5350	2550	1360
		fc	1490	497	237	126
菲涅尔镜头 GF14(泛光)	lux	5440	2080	1130	688	
	fc	506	193	105	64	
B(蓝光)	裸灯	lux	471	199	119	78
		fc	44	19	11	7
	带反光罩 GR15(15°)	lux	9070	3060	1500	908
		fc	843	284	139	84
	带反光罩 GR30(30°)	lux	4120	1410	719	453
		fc	383	131	67	42
	带反光罩 GR45(45°)	lux	1910	693	375	244
		fc	177	64	35	23
	带反光罩 GR60(60°)	lux	1080	414	235	156
		fc	100	39	22	15
	菲涅尔镜头 GF14(聚光)	lux	5020	1670	803	430
		fc	467	155	75	40
菲涅尔镜头 GF14(泛光)	lux	1740	667	362	222	
	fc	162	62	34	21	

照度数据 (高速模式)

色温	测试条件	照度单位	3m	5m	7m	9m
1800K	裸灯	lux	1360	596	327	181
		fc	126	55	30	17
	带反光罩 GR15(15°)	lux	23900	8370	4330	2530
		fc	2220	778	402	235
	带反光罩 GR30(30°)	lux	11900	4250	2170	1310
		fc	1100	395	201	122
	带反光罩 GR45(45°)	lux	5460	2070	1100	701
		fc	507	192	102	65
	带反光罩 GR60(60°)	lux	3140	1210	665	420
		fc	292	112	62	39
	菲涅尔镜头 GF14(聚光)	lux	14600	4960	2470	1320
		fc	1360	461	230	122
菲涅尔镜头 GF14(泛光)	lux	4780	1890	1030	659	
	fc	444	175	95	61	
2800K	裸灯	lux	6220	2630	1480	842
		fc	578	245	138	78
	带反光罩 GR15(15°)	lux	114000	38300	20000	11500
		fc	10600	3560	1860	1070
	带反光罩 GR30(30°)	lux	54100	19400	9770	5850
		fc	5022	1800	907	543
	带反光罩 GR45(45°)	lux	23200	7960	4840	3110
		fc	2160	739	450	288
	带反光罩 GR60(60°)	lux	14200	5420	2920	1920
		fc	1320	503	271	178
	菲涅尔镜头 GF14(聚光)	lux	65700	22100	11100	6750
		fc	6100	2060	1030	627
菲涅尔镜头 GF14(泛光)	lux	22000	8250	4610	2990	
	fc	2040	766	428	278	
3200K	裸灯	lux	6520	2790	1550	950
		fc	606	259	144	88
	带反光罩 GR15(15°)	lux	122000	42000	21500	12800
		fc	11300	3900	1990	1190
	带反光罩 GR30(30°)	lux	57900	19100	10300	6240
		fc	5380	1780	956	579
	带反光罩 GR45(45°)	lux	26200	9410	5140	3240
		fc	2430	874	478	301
	带反光罩 GR60(60°)	lux	14900	5740	3120	2030
		fc	1390	534	290	188
	菲涅尔镜头 GF14(聚光)	lux	70200	23700	11700	7070
		fc	6520	2200	1080	657
菲涅尔镜头 GF14(泛光)	lux	23600	8900	1080	3140	
	fc	2190	827	453	292	

色温	测试条件	照度单位	3m	5m	7m	9m
4300K	裸灯	lux	6300	2680	1500	952
		fc	585	249	140	88
	带反光罩 GR15(15°)	lux	122000	41900	21100	12700
		fc	11300	3890	1960	1180
	带反光罩 GR30(30°)	lux	56100	19000	9870	6060
		fc	5210	1770	917	563
	带反光罩 GR45(45°)	lux	25300	9330	4970	3140
		fc	2350	867	461	292
	带反光罩 GR60(60°)	lux	14500	5540	3010	1950
		fc	1350	514	280	182
菲涅尔镜头 GF14(聚光)	lux	67700	22800	11200	6800	
	fc	6290	2120	1040	632	
菲涅尔镜头 GF14(泛光)	lux	23000	8770	4720	3040	
	fc	2140	815	438	282	
5600K	裸灯	lux	6020	2570	1430	917
		fc	559	238	133	85
	带反光罩 GR15(15°)	lux	118000	40400	20300	12200
		fc	10900	3750	1890	1130
	带反光罩 GR30(30°)	lux	53900	18300	9490	5800
		fc	5010	1700	882	539
	带反光罩 GR45(45°)	lux	24400	9000	4760	3010
		fc	2260	836	443	279
	带反光罩 GR60(60°)	lux	13900	5360	2880	1880
		fc	1290	498	268	174
菲涅尔镜头 GF14(聚光)	lux	64800	21900	10800	6510	
	fc	6020	2040	1000	604	
菲涅尔镜头 GF14(泛光)	lux	22100	8400	4530	2910	
	fc	2050	780	421	270	
6500K	裸灯	lux	5380	2290	1280	821
		fc	500	213	119	76
	带反光罩 GR15(15°)	lux	106000	36300	18200	11000
		fc	9800	3370	1690	1020
	带反光罩 GR30(30°)	lux	48100	16500	8440	5180
		fc	4470	1530	784	481
	带反光罩 GR45(45°)	lux	22000	8060	4250	2690
		fc	2040	749	395	250
	带反光罩 GR60(60°)	lux	12400	4780	2570	1670
		fc	1160	444	239	156
菲涅尔镜头 GF14(聚光)	lux	58000	19500	9570	5780	
	fc	5390	1810	889	537	
菲涅尔镜头 GF14(泛光)	lux	19800	7520	4040	2590	
	fc	1840	699	375	241	

色温	测试条件	照度单位	3m	5m	7m	9m
8500K	裸灯	lux	4610	1940	1150	735
		fc	428	181	107	69
	带反光罩 GR15(15°)	lux	90400	31000	15600	9370
		fc	8400	2880	1450	871
	带反光罩 GR30(30°)	lux	41100	14100	7200	4580
		fc	3820	1310	669	425
	带反光罩 GR45(45°)	lux	18800	6900	3660	2410
		fc	1750	641	340	224
	带反光罩 GR60(60°)	lux	10600	4080	2290	1530
		fc	989	379	213	142
	菲涅尔镜头 GF14(聚光)	lux	49500	16700	8160	4940
		fc	4600	1550	758	459
菲涅尔镜头 GF14(泛光)	lux	16900	6440	3500	2150	
	fc	1570	598	325	201	
10000K	裸灯	lux	4410	1890	1115	710
		fc	409	176	104	66
	带反光罩 GR15(15°)	lux	86900	29800	15000	9020
		fc	8070	2770	1390	838
	带反光罩 GR30(30°)	lux	39500	13600	6920	4310
		fc	3670	1260	643	396
	带反光罩 GR45(45°)	lux	18100	6640	3500	2220
		fc	1680	617	325	207
	带反光罩 GR60(60°)	lux	10200	3930	2210	1510
		fc	951	366	205	141
	菲涅尔镜头 GF14(聚光)	lux	47600	16100	7860	4740
		fc	4420	1490	730	441
	菲涅尔镜头 GF14(泛光)	lux	16300	6210	3350	2140
		fc	1510	577	311	199

色温	测试条件	照度单位	3m	5m	7m	9m
R(红光)	裸灯	lux	782	324	190	128
		fc	73	30	18	11
	带反光罩 GR15(15°)	lux	14800	4890	2440	1450
		fc	1380	455	227	135
	带反光罩 GR30(30°)	lux	6690	2420	1230	747
		fc	621	225	114	69
	带反光罩 GR45(45°)	lux	3070	1140	623	403
		fc	285	108	58	37
	带反光罩 GR60(60°)	lux	1780	682	382	248
		fc	165	63	36	23
菲涅尔镜头 GF14(聚光)	lux	8360	2820	1410	702	
	fc	777	262	131	66	
菲涅尔镜头 GF14(泛光)	lux	2650	1050	575	352	
	fc	246	98	53	33	
G(绿光)	裸灯	lux	1470	621	350	229
		fc	137	58	33	21
	带反光罩 GR15(15°)	lux	29300	9680	4750	2870
		fc	2720	899	441	266
	带反光罩 GR30(30°)	lux	13100	4490	2300	1410
		fc	1210	417	214	131
	带反光罩 GR45(45°)	lux	6040	2230	1170	769
		fc	561	207	109	71
	带反光罩 GR60(60°)	lux	3410	1310	724	481
		fc	317	121	67	45
菲涅尔镜头 GF14(聚光)	lux	15900	5370	2580	1390	
	fc	1481	499	239	129	
菲涅尔镜头 GF14(泛光)	lux	5410	2070	1110	698	
	fc	503	192	103	65	
B(蓝光)	裸灯	lux	472	196	110	74
		fc	44	18	10	7
	带反光罩 GR15(15°)	lux	9110	2940	1450	884
		fc	846	273	135	82
	带反光罩 GR30(30°)	lux	4170	1440	724	448
		fc	387	133	67	41
	带反光罩 GR45(45°)	lux	1920	703	368	233
		fc	178	65	34	22
	带反光罩 GR60(60°)	lux	1100	417	224	147
		fc	102	39	21	14
菲涅尔镜头 GF14(聚光)	lux	5040	1690	817	446	
	fc	468	157	76	41	
菲涅尔镜头 GF14(泛光)	lux	1740	684	352	229	
	fc	162	64	33	21	

数据均为平均值, 非绝对值, 以上测试皆在灯体 100%亮度下进行。

反光罩 GR15、反光罩 GR30、反光罩 GR60 以及菲涅尔镜头 GF14 非标配附件, 如有需要可另购。

规格参数

型号	MG1200R
供电	100V-240V~60/50Hz
输入功率	1600W
色温	1800-10000K
调光范围	0% -100%
调光曲线	线性 /S 曲线 / 指数 / 对数
FX 光效	14 类
平均 CRI	≥ 96 (2800-10000K)
平均 TLCI	≥ 95 (2800-10000K)
灯体 / 控制器防水等级	IP54
控制方式	DMX 512 光控台控制, 支持 RDM 协议 /LumenRadio CRMX 控制 / 蓝牙 APP 控制 / 以太网支持 Art-Net & sACN 协议 / 离机遥控器控制 / 灯体控制 (离机遥控器需另购)
蓝牙控制距离	最远 40m
U 型支架调节角度	360°
Type-A USB 接口	固件升级 /5V \pm 1.5A 供电
尺寸 \approx	灯体 (包含 U 型支架): 400mm \times 589mm \times 339mm 控制器: 189mm \times 174mm \times 404mm
净重 \approx	灯体 (不含 U 型支架和反光罩): 9.8kg 控制器: 6.7kg

设计和规格如有变更, 恕不另行通知。

Safety Instructions and Attentions

First of all, as the most basic principle: This product is a professional lighting set equipment and should be used by professional lighting engineers or under the guidance of professionals. Basic safety attentions must always be followed during use, as follows:

1. Before use, please read and understand these instructions and attentions.
2. Professional lighting is prohibited for children. When children are near, parents or accompanying persons must supervise closely to prevent children from personal injury due to collision with lamps or private use of lamps.
3. This lighting product is not ordinary lighting product and cannot be used for general lighting. Anyone who has suffered eye damage or has sensitive eyes should avoid using this product.
4. When the lamp is on, it must be used with care. Do not touch high-temperature parts, such as LED lamp beads, to avoid burns.
5. When the lamp is on, it is forbidden to look directly at the lamp beads under any circumstances. Strong light should be used under the guidance of professional lighting engineers. Avoid prolonged exposure to strong light under any circumstances. If eye discomfort, please turn off the lamp in time, suspend use, and see a doctor immediately.
6. If the lamp bead is damaged or deformed by heat, stop using this equipment, and contact the manufacturer, service agent or qualified maintenance personnel to replace the lamp bead in time to avoid accidents.
7. This product is only suitable for use in -20°C to 45°C operating environment and normal humidity environment.
8. Do not use damaged equipment or accessories, and wait for professional maintenance personnel to check and repair to confirm being normal before use.
9. During using, if the casing of this product is broken due to being dropped, squeezed or subjected to strong impact, please do not use it, so as to avoid electric shock injury due to contact with internal electronic components.
10. If an extension cord is required, please use an extension cord with a current rating greater than or equal to that of the equipment. If an extension cord is rated less than the equipment, overheating may result.
11. Some products have long power cords, please place the power cords properly and keep them in a safe place. Avoid contacting the power cord with overheating surfaces, avoid improper placement that could cause pulling damage, or trip on-site personnel. Please use the certified power cord from the original manufacturer. If the product is damaged by using a non-certified power cord, it will not be repaired by our factory.
12. Be sure to unplug equipment from the power outlet before cleaning and repairing. When not in use, do not pull the power cord to unplug the equipment. For normal power-off, please hold both ends of the plug of the equipment with your hands and pull the plug out of

power outlet. This equipment needs to be connected to a grounded outlet.

13. Do not disassemble the product without permission. If the product fails, it must be checked and repaired by authorized maintenance personnel.

14. Before storing, make sure that the equipment has cooled down completely. For storage, unplug the power cord from the equipment. The equipment should be placed in the carrying case or in a ventilated dry place.

15. Do not place equipment near flammable and volatile solvents such as alcohol and gasoline.

16. Do not use accessories that are not recommended by our factory to avoid fire, electric shock or personal injury.

17. When cleaning, do not wipe it with a damp cloth, please use a dry cloth or a soft cloth to wipe the dirt of the equipment.

18. Please take off the protective cover before using.

19. This product complies with ROHS, CE and FCC certification, please refer to the relevant national standards for use and operation.

20. The safety instructions are formulated according to the strict testing of the factory, and the design and specifications of the equipment are subject to change without prior notice. For latest product information, please check the GODOX website and view latest electronic instruction.

21. Some products have built-in lithium batteries. Please use specified chargers, and use them within a proper range of the specified voltage and temperature according to the correct operating instructions.

22. Some products are battery powered. Do not use any batteries, power sources or accessories not specified in the instructions for such products. Keep batteries and other accessories out of the reach of children and infants. In the instance that a child or infant swallows a battery or accessory, immediate emergency medical attention is required. If the battery leaks, becomes discolored, deformed, emits smoke, or emits an abnormal odor, remove it immediately. Be careful during removal to avoid burns. Continued use could result in fire, electric shock, or burns. Do not use any deformed or modified batteries. Do not disassemble or modify this product or battery. Do not heat or solder the battery. Keep the battery away from fire or water. Do not incorrectly insert the positive and negative ends of batteries, or mix old and new batteries or batteries of different types together.

23. One-year warranty period, accessories such as consumable batteries, adapters, power cords, etc. are not covered by this warranty.

24. If it is found that the equipment is repaired without authorization, the one-year warranty period will be cancelled and relevant fees will be charged for maintenance.

25. Machine failures caused by non-standard operation are not covered by the warranty.

keep these instructions!



Do not stare at the operating light source

Warning







Thank you for purchasing!

MG1200R is Godox's latest and greatest full-color LED light ever, with the following powerful features and functions: input power of 1600W and max.output power of 1500W, support 100V-240V power supply, full-color RGB mode, ultra-high and thousand-bit adjustable brightness, separated design of light body and controller, protection grade of IP54, four dimming curves, wide CCT range from 1800K to 10000K, various wireless controlling methods, and etc. This new product is suitable for shooting scenes in large film studios, broadcast studios, outdoor exteriors and large field scenes.

Main Features

- Four dimming curves: linear, S-curve, exponential, logarithmic.
- 1500W strong output power, and thousand-bit adjustable brightness from 0% to 100% .
- Wide CCT range adjustable from 1800K to 10000K.
- Various controlling methods: support DMX 512/LumenRadio CRMX/Bluetooth app/Ethernet control, and Art-Net & sACN protocol.
- Brand new Godox mount enables smart optics recognition.
- Protection grade of IP54 keeps the light head and controller from dust and water.
- Adopt efficient heat dissipation system design with large fan to meet the cooling needs of large LED light.
- 14 FX modes: flash, lightning, cloudy, broken bulb, TV, candle, fire, firework, explosion, welding, cop car, SOS, RGB cycle, party.

Warnings

-  Do not look directly at the LED light or illuminate at others' eyes.
-  Do not plug or unplug the power cable or connecting cable when the power is turned on, otherwise personal injuries may occur.
-  Do not cover the heat dissipation vent in working status.
-  Keep out of reach of children.
-  Please make sure to follow the instruction manual and correctly use this professional lighting device.
-  **Please always keep the light body clean, otherwise the glass may explode due to mosquito stains or dark organic stains.**

Name of Parts

Light Body

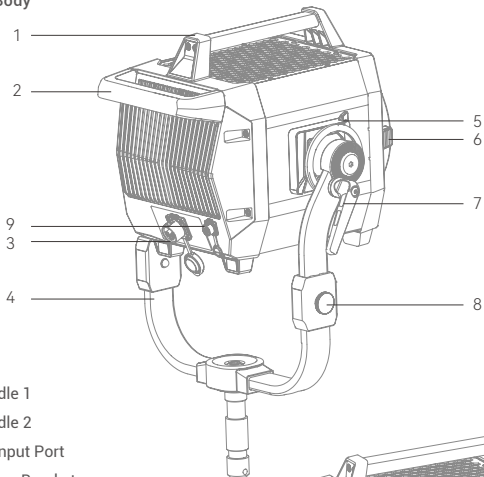

1. Handle 1
2. Handle 2
3. DC Input Port
4. U-type Bracket
5. Quick Install Device
6. Mount Locking Pusher
7. Direction Adjust Handle
8. Cable Hanging Device
9. ACC Port
10. Godox Mount

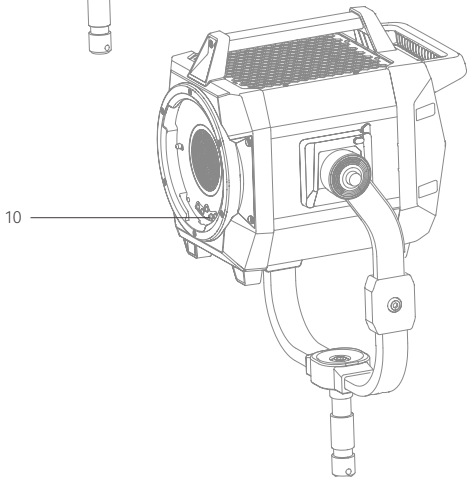

Controller

1. Power Switch
2. Remove Controller Port
3. DC Output Port
4. Display
5. PRESET Button
6. LOCK Button
7. MENU Button
8. MODE Button
9. Select Dial
10. LED Status Indicator
11. DMX OUT Port
12. DMX IN Port
13. USB-A Port
14. Ethernet Port
15. AC Input Port

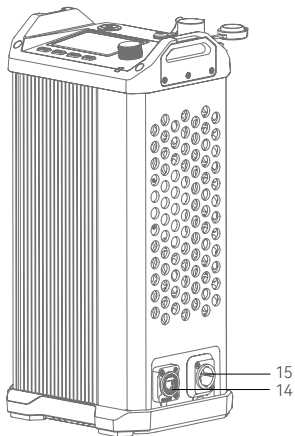
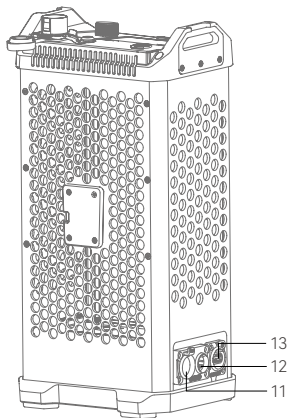
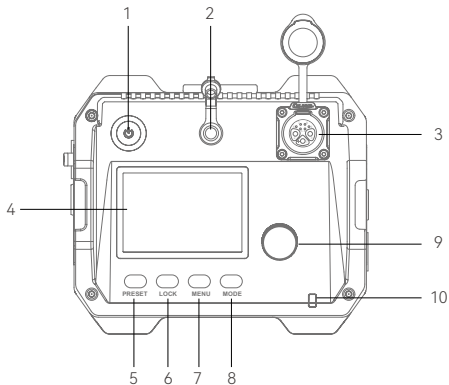

What's Inside MG1200R

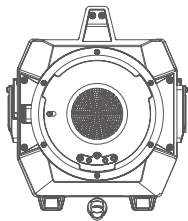

Light Body × 1

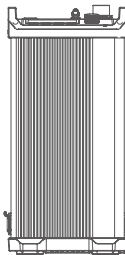

Controller × 1



Protection Cover × 1

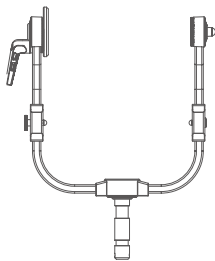

U-type Bracket × 1

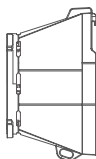

Reflector GR45 × 1

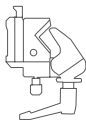

Controller Mounting Device × 1



Instruction Manual × 1



DMX Mode Specification × 1



Tying Rope × 1



Safety Rope × 1



DC Power Cord × 1



AC Power Cord × 1

What's Inside MG1200R K1

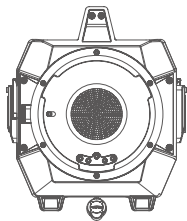

Light Body × 1

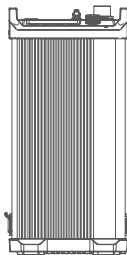

Controller × 1



Protection Cover × 1

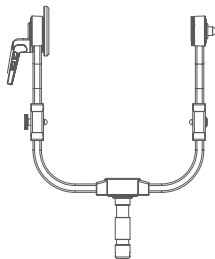

U-type Bracket × 1

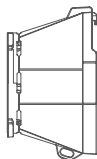

Reflector GR45 × 1

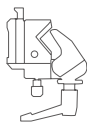

Controller Mounting Device × 1



Instruction Manual × 1



DMX Mode Specification × 1



Tying Rope × 1



Safety Rope × 1



DC Power Cord × 1



AC Power Cord × 1

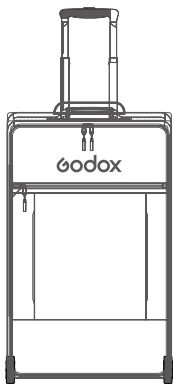

Storage Bag × 1

What's Inside MG1200R K2

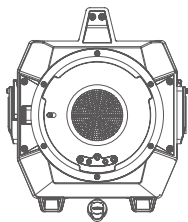

Light Body × 1

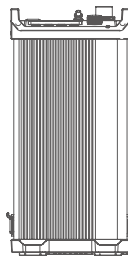

Controller × 1

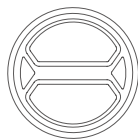

Protection Cover × 1

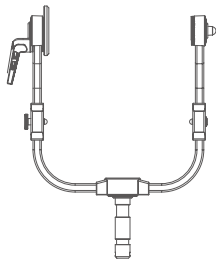

U-type Bracket × 1

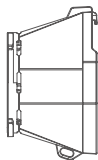

Reflector GR45 × 1

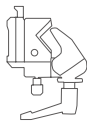

Controller Mounting Device × 1



Instruction Manual × 1



DMX Mode Specification × 1



Tying Rope × 1



Safety Rope × 1



DC Power Cord × 1



AC Power Cord × 1

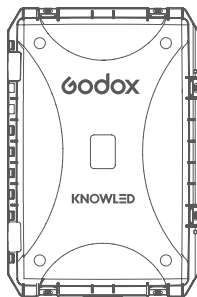

Carry Case × 1

What's Inside MG1200R K3

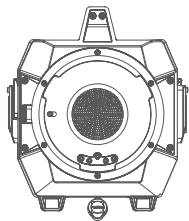

Light Body × 1

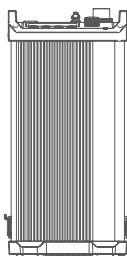

Controller × 1



Protection Cover × 1

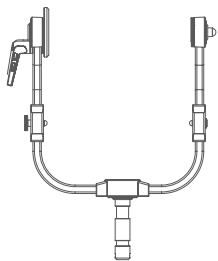

U-type Bracket × 1

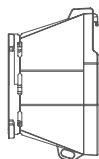

Reflector GR45 × 1

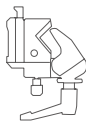

Controller Mounting Device × 1



Instruction Manual × 1



DMX Mode Specification × 1



Tying Rope × 1



Safety Rope × 1



DC Power Cord × 1



AC Power Cord × 1



Flight Case × 1

Note: Due to continuous updates and upgrades of the products, there may be differences between the actual products and the pictures. Therefore, the pictures are for reference only, products to prevail in kind.

Separately Sold Accessories

Reflector GR15, Reflector GR30, Reflector GR60, Fresnel Lens GF14

Installation and Disassembly

1. Installing the U-type Bracket

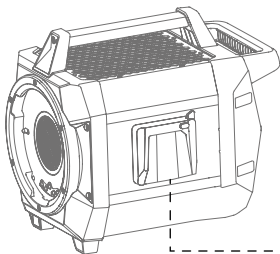

1.1 Place the light on a flat surface with the heat dissipation side upward.

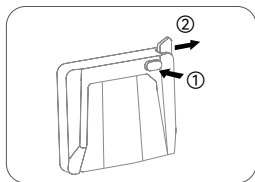

1.2 Press down the quick install device button and remove the wrench.

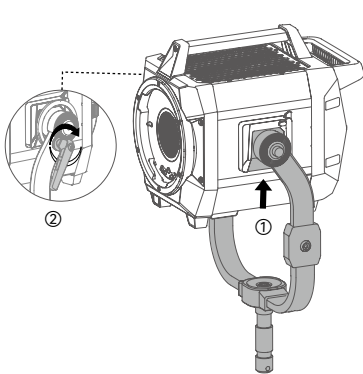

1.3 Align both ends of the U-type bracket with the quick install device, lock the wrenches on both sides, and then "click" means successfully installed.

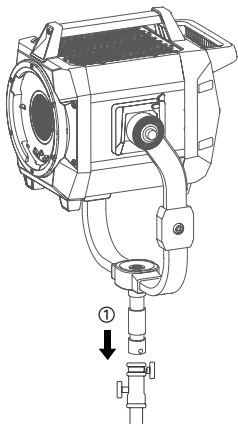

1.4 Install the light on the roller stand and lock the fixing knob on the roller stand.
Note: The roller stand is sold separately.

⚠ Please be careful when installing the light as it is quite heavy.

2. Disassembly the U-type Bracket

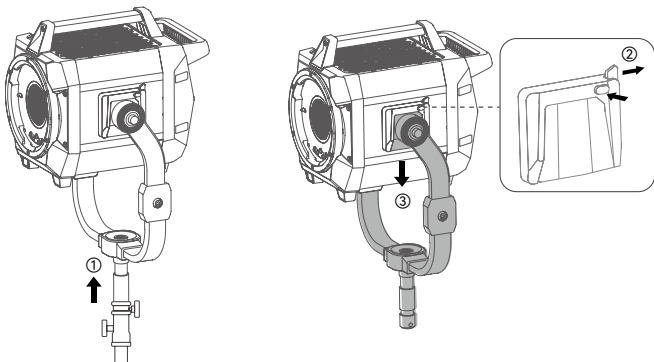

2.1 Hold the handle of the light and remove it from the roller stand then place it on a flat surface.

2.2 Press and hold the quick install device button and release the wrench to remove the light.

3. Installation/Disassembly the Light Protection Cover

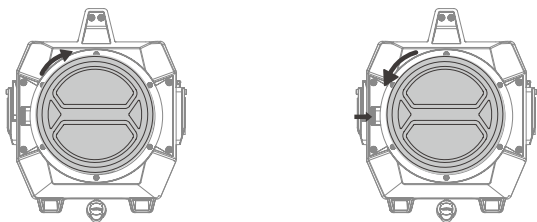

3.1 Align the light protection cover with the mount and rotate clockwise to install.

3.2 Press and hold the mount locking pusher and rotate counterclockwise to remove the light protection cover.

4. Installation/Disassembly the Reflector

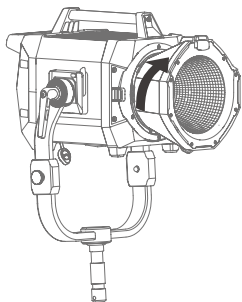

4.1 Align the reflector with the mount, insert and then rotate clockwise to install.

Note: Make sure to insert after aligning with the mount.

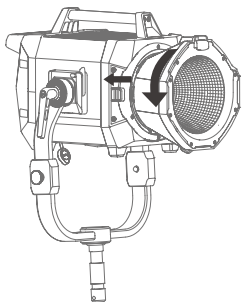

4.2 Press and hold the mount locking pusher and rotate counterclockwise to remove the light protection cover.

5. Installing the Controller onto the Light Stand

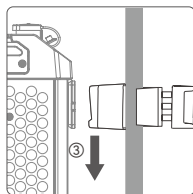
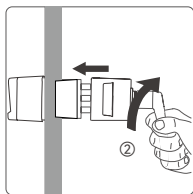

Loosen the handle of controller mounting device and insert the light stand pole, rotate the handle clockwise to lock the mounting device, then align the quick install device with the slot of mounting device and insert it.

6. Connect to DMX 512 Controller

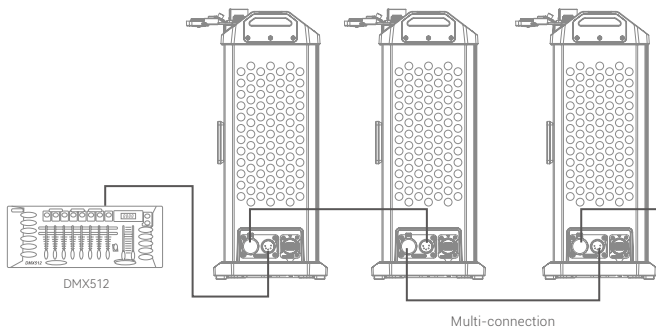

Note: The DMX 512 controller is sold separately.

Power Supply

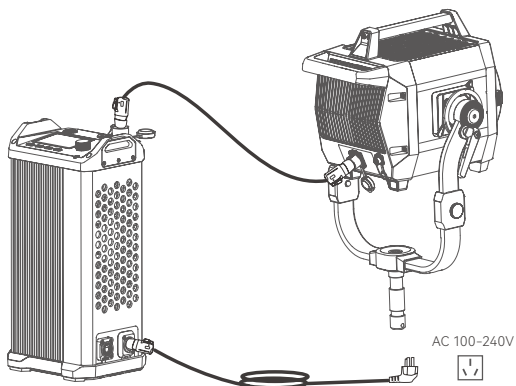

⚠ Do not plug or unplug the power cable or connecting cable when the power is turned on, otherwise injuries may occur.

Power Switch

Short press the power switch on the controller after connected to power source to turn on or off the device.

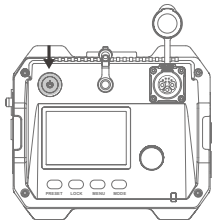

Mode Selection

Rotate the select dial in mode interface to choose among the following 6 modes, short press the select dial can enter the desired mode setting interface.



CCT Mode

Short press the MODE button to enter mode selection, rotate and press the select dial to select CCT mode, in which you can adjust the DIM/CCT/GM. Rotate the select dial clockwise to increase the parameters, while rotate anticlockwise to decrease the parameters.

DIM range: 0% ~ 100%
CCT range: 1800K ~ 10000K
GM range: -100% ~ +100%

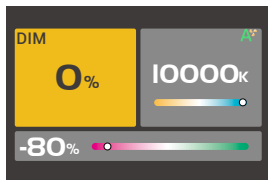

HSI Mode

Short press the MODE button to enter mode selection, rotate and press the select dial to select HSI mode, in which you can adjust the DIM/HUE/SAT. Rotate the select dial clockwise to increase the parameters, while rotate anticlockwise to decrease the parameters.

DIM range: 0% ~ 100%

HUE range: 0° ~ 360°

SAT range: 0% ~ 100%

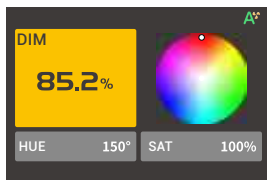

RGBW Mode

Short press the MODE button to enter mode selection, rotate and press the select dial to select RGBW mode, in which you can adjust the DIM/red/green/blue/white. Rotate the select dial clockwise to increase the parameters, while rotate anticlockwise to decrease the parameters.

DIM range: 0% ~ 100%

Red range: 0% ~ 100%

Green range: 0% ~ 100%

Blue range: 0% ~ 100%

White range: 0% ~ 100%

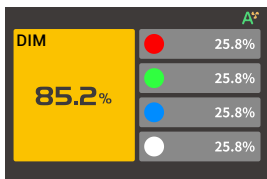

GEL Mode

Short press the MODE button to enter mode selection, rotate and press the select dial to select GEL mode, in which you can adjust the DIM/gel type/gel group type/color/CCT/HUT/SAT. Rotate the select dial clockwise to increase the parameters, while rotate anticlockwise to decrease the parameters.

DIM range: 0% ~ 100%

Gel type: R-GEL/L-GEL

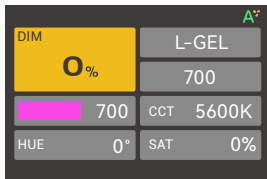

GEL Group Type (R-GEL)

COR. / CAL. / SPC. / CINE.

GEL Group Type (L-GEL)

COR. / COLOR. / 600 / COS. / 700

CCT range: 3200K or 5600K

HUE range: -10° ~ 10°

SAT range: -20% ~ 20%

X-Y Mode

Short press the MODE button to enter mode selection, rotate and press the select dial to select X-Y mode, in which you can adjust the DIM/X coordinate/Y coordinate/color temperature/color space. Rotate the select dial clockwise to increase the parameters, while rotate anticlockwise to decrease the parameters.

DIM range: 0% ~ 100%

X coordinate: 0.0000 ~ 0.8500

Y coordinate: 0.0000 ~ 0.8500

Color temperature or color space: Gamut, Rec.2020, DCI-P3, Rec.709, Black body

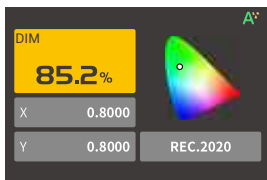

FX Mode

Short press the MODE button to enter mode selection, rotate and press the select dial to select FX mode, in which you can choose among the 14 effects (flash, lightning, cloudy, broken bulb, TV, candle, fire, fireworks, explosion, welding, cop car, SOS, RGB cycle, party) and adjust their respective parameters. Rotate the select dial clockwise to increase the parameters, while rotate anticlockwise to decrease the parameters.

1. Flash

This effect simulates a camera flash or flash bulb and is often used to create a vivid, lively atmosphere.

DIM: 0% -100% (in 0.1% increment)

Switch: Turn on/off the effect

Color: CCT/HSI

CCT/HUE: 1800K-10000K/0-360°

Trigger: Auto/Manual

Speed: 1-100

Mode: Camera Flash/Flash Bulb

2. Lightning

This effect simulates the natural thunder and lightning and is often used to create a tense, terrifying or mysterious atmosphere.

DIM: 0% -100% (in 0.1% increment)

Switch: Turn on/off the effect

CCT: 1800K-10000K

Trigger: Auto/Manual

Times: Random/1-10

Frequency: Random /2-20

3. Cloudy

This effect simulates the effect of cloud occlusion and is often used to create a gloomy, oppressive or sad atmosphere.

DIM: 0% -100% (in 0.1% increment)

Switch: Turn on/off the effect

Ratio: 30% -90%

Speed: Random/1-100

4. Broken Bulb

This effect simulates the effect of a broken bulb and is often used to create a dim atmosphere.

DIM: 0% -100% (in 0.1% increment)

Switch: Turn on/off the effect

Color: CCT/HSI

CCT/HUE: 1800K-10000K/0-360°

Speed: 1-100

5. TV

This effect simulates the effect of light from a television or screen and is often used to create a cold, mechanical or digital atmosphere.

DIM: 0% -100% (in 0.1% increment)

Switch: Turn on/off the effect

Color: CCT/HSI

Speed: 1-100

6. Candle

This effect simulates the effect of light from a candle and is often used to create a soft, warm, shimmering atmosphere.

DIM: 0% -100% (in 0.1% increment)

Switch: Turn on/off the effect

Speed: 1-100

7. Fire

This effect simulates the effect of light from flame and is often used to create a bright, warm, shimmering atmosphere.

DIM: 0% -100% (in 0.1% increment)

Switch: Turn on/off the effect

Speed: 1-100

8. Firework

This effect simulates the effect of light from fireworks and is often used to create a gorgeous, colorful, romantic atmosphere.

DIM: 0% -100% (in 0.1% increment)

Switch: Turn on/off the effect

Embers: 1-100

Speed: 1-100

9. Explosion

This effect simulates the effect of light from explosion and is often used to create a bright, fierce, shimmering atmosphere.

DIM: 0% -100% (in 0.1% increment)

Switch: Turn on/off the effect

Color: CCT/HSI

CCT/HUE: 1800K-10000K/0-360°

Trigger: Auto/Manual

Embers: 1-100

Speed: 1-100

10. Welding

This effect simulates the effect of light from welding and is often used to create a hot, mechanical atmosphere.

DIM: 0% -100% (in 0.1% increment)

Switch: Turn on/off the effect

Color: CCT/HSI

CCT/HUE: 1800K-10000K/0-360°

Speed: 1-100

11. Cop Car

This effect simulates the effect of light from cop car and is often used to create a tension, chasing atmosphere.

DIM: 0% -100% (in 0.1% increment)

Switch: Turn on/off the effect

Color: Red+Blue/Red/Blue/Blue+White/Blue+Yellow/Yellow/Red+White+Blue/Red+Yellow+Blue

Mode: 1-5

12. SOS SOS

This effect simulates the flashing effect of an SOS signal and is often used to create a dangerous, distress or emergency atmosphere.

DIM: 0% -100% (in 0.1% increment)

Switch: Turn on/off the effect

Color: CCT/HSI

CCT/HUE: 1800K-10000K/0-360°

13. RGB Cycle



This effect simulates the effect cycle and change of colorful lights and is often used to create a fantasy, sci-fi atmosphere.

DIM: 0% -100% (in 0.1% increment)

Switch: Turn on/off the effect

SAT: 0%-100%

Speed: 1-100

14. Party



This effect simulates the effect of colorful lights, flashes and laser, and is often used to create a carnival, fun, high energetic atmosphere.

DIM: 0% -100% (in 0.1% increment)

Switch: Turn on/off the effect

















SAT: 0%-100%

Speed: 1-100

Note: Please rotate the select dial to adjust the parameters, then press and rotate it to the next parameter. Select manual, the effect can be triggered once by pressing the select dial once. After a certain effect is set, press MODE button can return to the 14 effects interface.

Menu Settings

Short press the MENU button to enter menu settings, rotate the select dial to select among the following options: DMX, CRMX, Bluetooth, network settings, Art-Net & sACN, optics recognition, dimming curves, smoothing, control mode, color space, fan, display, language, version & upgrade, factory reset, fixture info.

	DMX	512
	CRMX	On
	Bluetooth	On
	Network Settings	Auto
	Art-Net & sACN	Auto
	Optics Recognition	On
	Dimming Curves	Linear
	Smoothing	Smooth
	Control Mode	Normal
	Color Space	Original Gamut
	Fan	ON
	Display	80%
	Language	English
	Version & Upgrade	V1.00
	Factory Reset	002
	Fixture Info	MG1200R

1. DMX

Short press the select dial to enter DMX setting interface. Rotate the select dial to select options among address, DMX mode, RDM state, DMX lost, termination, extend DMX channels. Short press the select dial to select the desired option then rotate to adjust settings. Finally, short press the select dial to exit the current setting, short press the MENU button to return to the previous menu.

D

DMX	
Address	510
DMX Mode	16:GEL 16bit
RDX State	Off
DMX Lost	Hold Last Command
Termination	Off
Extend DMX Channels	Off

Level 1 Option	Level 2 Option	Description
Address	001-512	Initial Address
DMX Mode	01: CCT 8 Bit	CCT Mode in 8 bit
	02: HSI 8 Bit	HSI Mode in 8 bit
	03: RGB 8 Bit	RGB Mode in 8 bit
	04: RGBW 8 Bit	RBGW Mode in 8 bit
	05: CCT+HSI 8 Bit	CCT & HSI Mode in 8 bit
	06: CCT+RGBW 8 Bit	CCT & RGBW Mode in 8 bit
	07: FX 8 Bit	FX Mode in 8 bit
	08: GEL 8 Bit	GEL Mode in 8 bit
	09: CCT 16 Bit	CCT Mode in 16 bit
	10: HSI 16 Bit	HSI Mode in 16 bit
	11: RGB 16 Bit	RGB Mode in 16 bit
	12: RGBW 16 Bit	RBGW Mode in 16 bit
	13: X-Y 16 Bit	X-Y Mode in 16 bit
	14: FX 16 Bit	FX Mode in 16 bit
	15: GEL 16 Bit	GEL Mode in 16 bit
RDM State	On	Turn on RDM, the ADD and DMX mode can be set by controller.
	Off	Turn off RDM
DMX Lost	Hold Last Command	After the DMX control signal is lost, continue to use the last received DMX control signal until power down or a valid DMX control signal is received again.
	Black Out	The light is off immediately.
	Black Out After 2 Min.	After the DMX control signal is lost, continue to use the last received DMX control signal for 2 minutes then black out. Note: If a valid DMX control signal is received within 2 minutes, then use the new DMX control signal.
Termination	On	Turn on DMX terminal
	Off	Turn off DMX terminal
Extend DMX	On	Turn on extend DMX channels
Channels	Off	Turn off extend DMX channels

Note: Please refer to the "MG1200R DMX Mode Specification" to control the device by DMX/RDM. The electronic version can be downloaded from the official website <https://www.godox.com>.

2. CRMX

Short press the select dial to enter CRMX setting interface. Rotate the select dial to select options between switch and mode. Short press the select dial to select the desired option then rotate to adjust settings. Finally, short press the select dial to exit the current setting, short press the MENU button to return to the previous menu.

Note: Please reset before choosing transmitter/receiver mode.

CRMX	↶
CRMX	On
Mode	Transmitter
Output Power	20dBm
Link	Link
Reset	Reset

Transmitter mode in CRMX

CRMX	↶
CRMX	On
Mode	Receiver
Reset	Reset

Receiver mode in CRMX

Level 1 Option	Level 2 Option	Reset
CRMX	On	Turn on CRMX
	Off	Turn off CRMX
Mode	Transmitter	Transmitter mode
	Receiver	Receiver mode
Output Power	5dBm	Output power value = 5dBm (only adjustable in transmitter mode)
	11dBm	Output power value = 11dBm (only adjustable in transmitter mode)
	16dBm	Output power value = 16dBm (only adjustable in transmitter mode)
	20dBm	Output power value = 20dBm (only adjustable in transmitter mode)
Reset	Reset	Restore to factory settings

Scan the QR code to download "Godox KNOWLED"app



3. Bluetooth

Short press the select dial to enter Bluetooth setting interface. Rotate the select dial to select options between switch and reset. Short press the select dial to select the desired option then rotate to adjust settings. Finally, short press the MENU button to return to the previous menu.

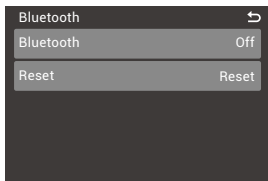

Scan the QR code to download the "Godox Light" smartphone app (can be used in Android and Apple).

Note: The app can be used directly on the firstly installed device (smartphone or iPad). When change to other mobile device (smartphone or iPad), the light shall be reset before the normal connection of APP.

Note: The app should be upgraded to version 3.0 or above.



4. Network Settings

Short press the select dial to enter network settings interface. Rotate and short press the select dial to select network mode, then rotate to select among DHCP, Art-Net 2.x, Art-Net 10.x and manual. Finally, short press the MENU button to return to the previous menu.

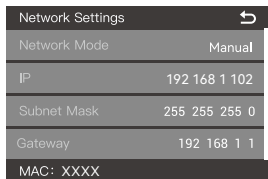

Level 1 Option	Level 2 Option	Description
Network Mode	DHCP	DHCP mode
	Art-Net2.x	To use 2.B.C.D network
	Art-Net 10.x	To use 10.B.C.D network
	Manual	Set the network IP, subnet mask, and default gateway manually
IP	AAA.BBB.CCC.DDD	The ID address is assigned by DHCP in DHCP mode. The ID address is 2.B.C.D in Art-Net 2.x mode. The ID address is 10.B.C.D in Art-Net 10.x mode. In manual mode: AAA = 0-255 BBB = 0-255 CCC = 0-255 DDD = 0-255
Subnet Mask	255.BBB.CCC.DDD	The subnet mask is 255.BBB.CCC.DDD and can not be adjusted by menu settings in DHCP/Art-Net 2.x/Art-Net 10.x mode. In manual mode: AAA = 0-255 BBB = 0-255 CCC = 0-255 DDD = 0-255
Gateway	AAA.BBB.CCC.DDD	The gateway is assigned by DHCP in DHCP mode. The gateway is 2.B.C.D in Art-Net 2.x mode. The gateway is 10.B.C.D in Art-Net 10.x mode. In manual mode: AAA = 0-255 BBB = 0-255 CCC = 0-255 DDD = 0-255

5. Art-Net & sACN

Short press the select dial to enter Art-Net & sACN setting interface. Rotate and short press the select dial to select options among auto, Art-Net, sACN and off, then other level 2 options are available to adjust. Finally, short press the MENU button to return to the previous menu.

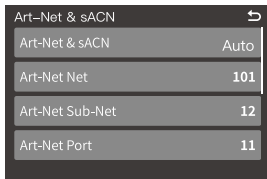

Level 1 Option	Level 2 Option	Description
Art-Net&sACN	Auto/Art-Net/sACN/Off	Auto: Art-Net & sACN two protocols are accepted. Art-Net: Only Art-Net protocol. sACN: Only sACN protocol. Off: No network protocols are accepted.
Art-Net Net	0-127	Art-Net network
Art-Net Sub-Net	0-15	Choose Art-Net subnet in Art-Net network.
Art-Net Port	0-15	Art-Net port
Art-Net Universe	0-32767	Art-Net domain
sACN Universe	1-63999	sACN domain

6. Optics Recognition

Short press the select dial to enter optics recognition setting interface. Rotate and short press the select dial to turn on or off the function. Finally, short press the MENU button to return to the previous menu.

Note: The light will not be lightened if the optics is not correctly installed even optics recognition function is turned on.

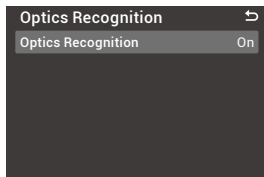

7. Dimming Curves

Short press the select dial to enter dimming curves setting interface. Rotate and short press the select dial to choose among linear, S-curve, exponential and logarithmic. Finally, short press the MENU button to return to the previous menu.

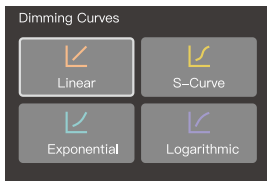

8. Smoothing

Short press the select dial to enter smoothing setting interface. Rotate and short press the select dial to choose among default, smooth and off. Finally, short press the MENU button to return to the previous menu.

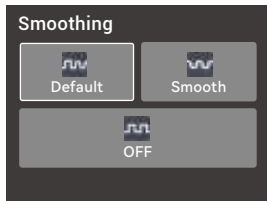

Smoothing	Note
Default	The brightness data is basically smoothed to achieve smooth dimming and shorten the response time.
Smooth	The brightness data is smoothed to achieve ultra-smooth dimming with a slow response time.
Off	No smoothing of brightness data, fastest response time.

9. Control Mode

Short press the select dial to enter control mode setting interface. Rotate and short press the select dial choose the mode among normal, low end or highspeed, then short press and rotate the select dial can adjust the frequency of normal and low end modes from 1 to 11. Finally, short press the MENU button to return to the previous menu.

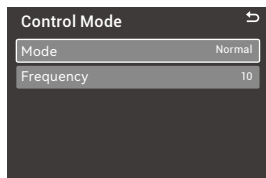

Control Mode	Suitable Environment	Dimming Feature	Blink
Normal	Normal dimming	Proper in the whole dimming range	Unlikely
Low End	TV series/Movie	Proper in low dimming	Probably
Highspeed	Not dimmable	/	No

10. Color Space

Short press the select dial to enter color space setting interface. Rotate and short press the select dial to select among original gamut, correction gamut, Rec. 709 and DCI-P3. Finally, short press the MENU button to return to the previous menu.

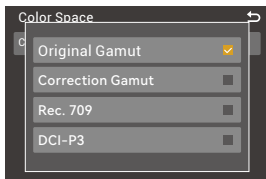

11. Fan

Short press the select dial to enter fan setting interface. Rotate and short press the select dial to choose among auto, medium, high and off. Finally, short press the MENU button to return to the previous menu.

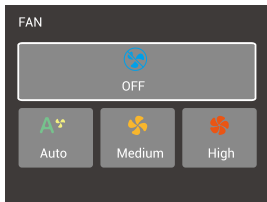

12. Display

Short press the select dial to enter display setting interface. Rotate and short press the select dial to adjust display brightness from 10% to 100%. Finally, short press the MENU button to return to the previous menu.

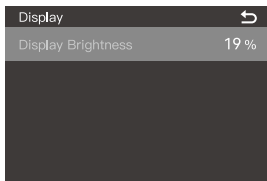

13. Language

Short press the select dial to enter language setting interface. Rotate and short press the select dial to select between simplified Chinese and English. Finally, short press the MENU button to return to the previous menu.

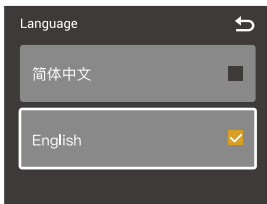

14. Version & Upgrade

Short press the select dial to enter version & upgrade setting interface to check the firmware version and upgrade instruction. Then, short press the MENU button to return to the previous menu.

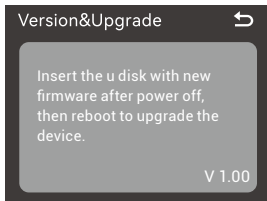

15. Factory Reset

Short press the select dial to enter factory reset setting interface. Rotate and short press the select dial to select yes or no. The brightness value will turn to 100% and reboot automatically after factory reset.

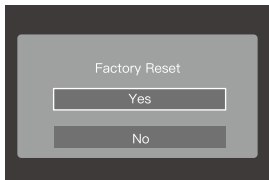

16. Fixture Info

Short press the select dial to enter fixture info setting interface to check model, UID, firmware version, temperature. Then, short press the MENU button to return to the previous menu.

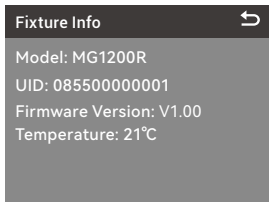

Lock Setting

Short press the LOCK button, the panel is locked when is displayed on the panel, short press again to unlock.

Note: The locking function only works on the controller panel, other operations are still available.

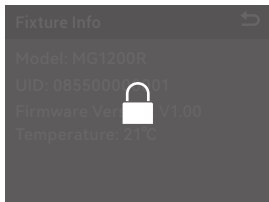

Preset Setting

Short press the PRESET button to enter preset effects interface. Rotate and short press the select dial to choose and enter preset effects 1-20, then short press to choose save or cancel. Finally, short press the MODE button to return to the main interface.

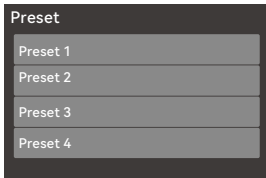

Software Upgrade

1. Download the new firmware to the U disk from official website(<https://www.godox.com/firmware-continuous-light>).
2. Turn off the device. Insert the U disk with new firmware into the Type-A USB port.
3. Turn on the device, and it will automatically enter the upgrading interface.
4. It will return to main interface after completion.

Notes:

1. New firmware must be downloaded from the official website, and keep only one BIN file in the root directory of the USB disk.
2. The Type-A USB port can only support output voltage and current of 5V/1.5A. Do not connect to over-rated USB device.

Maintenance

This product, except consumables, is supported with a one-year warranty.

Unauthorized service will void the warranty.

Maintenance of the light must be performed by our authorized maintenance department which can provide original accessories.

If the product had failures or was immersed into water, do not use it until it is repaired by professionals.

Shut down the device immediately should abnormal operation be detected.

Changes made to the specifications or designs may not be reflected in this manual.

Illuminance Data(Normal Mode)

CCT	Condition	Unit	3m	5m	7m	9m
1800K	Bare Light	lux	1500	634	380	205
		fc	139	59	35	19
	With Reflector GR15 (15°)	lux	29000	9700	4830	2960
		fc	2690	901	448	275
	With Reflector GR30 (30°)	lux	13000	4470	2340	1450
		fc	1210	415	218	134
	With Reflector GR45 (45°)	lux	6090	2200	1210	796
		fc	566	205	113	74
	With Reflector GR60 (60°)	lux	3450	1340	758	433
		fc	321	124	70	40
With Frensel Lens GF14 (Spot)	lux	16300	5520	2570	1360	
	fc	1510	513	239	126	
With Frensel Lens GF14 (Flood)	lux	5400	2080	1130	679	
	fc	502	193	105	63	
2800K	Bare Light	lux	5310	2200	1300	771
		fc	493	205	121	72
	With Reflector GR15 (15°)	lux	101000	34200	17200	10500
		fc	9410	3180	1600	979
	With Reflector GR30 (30°)	lux	46100	15700	8250	5160
		fc	4280	1460	766	479
	With Reflector GR45 (45°)	lux	21200	7720	4190	2460
		fc	1970	717	389	228
	With Reflector GR60 (60°)	lux	11900	4630	2620	1740
		fc	1110	430	244	161
With Frensel Lens GF14 (Spot)	lux	56700	19400	8770	4810	
	fc	5270	1800	814	447	
With Frensel Lens GF14 (Flood)	lux	19200	7280	3970	2420	
	fc	1780	676	369	225	
3200K	Bare Light	lux	5600	2330	1370	850
		fc	520	217	128	79
	With Reflector GR15 (15°)	lux	108000	36300	18100	11100
		fc	10000	3380	1680	1030
	With Reflector GR30 (30°)	lux	49100	16700	8650	5420
		fc	4560	1550	804	503
	With Reflector GR45 (45°)	lux	22600	8220	4430	2840
		fc	2100	764	412	263
	With Reflector GR60 (60°)	lux	12700	4890	2760	1850
		fc	1180	454	256	172
With Frensel Lens GF14 (Spot)	lux	60600	20400	9310	5120	
	fc	5630	1890	865	476	
With Frensel Lens GF14 (Flood)	lux	20400	7780	4210	2560	
	fc	1890	723	391	238	

CCT	Condition	Unit	3m	5m	7m	9m
4300K	Bare Light	lux	5440	2280	1340	844
		fc	505	211	124	78
	With Reflector GR15 (15°)	lux	105000	35500	17600	10700
		fc	9750	3300	1640	997
	With Reflector GR30 (30°)	lux	48000	16400	8390	5290
		fc	4460	1520	780	491
	With Reflector GR45 (45°)	lux	22100	8040	4300	2760
		fc	2050	747	400	256
	With Reflector GR60 (60°)	lux	12400	4760	2680	1800
		fc	1150	442	249	167
With Frensel Lens GF14 (Spot)	lux	58700	19700	9230	5030	
	fc	5460	1830	858	468	
With Frensel Lens GF14 (Flood)	lux	19900	7600	4120	2510	
	fc	1850	706	383	233	
5600K	Bare Light	lux	5220	2190	1290	824
		fc	485	203	120	77
	With Reflector GR15 (15°)	lux	101000	34200	16900	10300
		fc	9420	3180	1570	960
	With Reflector GR30 (30°)	lux	46100	15700	8040	5090
		fc	4280	1460	747	473
	With Reflector GR45 (45°)	lux	21300	7710	4150	2720
		fc	1980	716	385	253
	With Reflector GR60 (60°)	lux	12000	4600	2570	1730
		fc	1110	428	239	161
With Frensel Lens GF14 (Spot)	lux	56500	18900	8960	4830	
	fc	5250	1760	833	449	
With Frensel Lens GF14 (Flood)	lux	19200	7310	3960	2420	
	fc	1780	679	368	225	
6500K	Bare Light	lux	5030	2110	1240	799
		fc	467	196	115	74
	With Reflector GR15 (15°)	lux	98100	32800	16300	9970
		fc	9110	3050	1510	926
	With Reflector GR30 (30°)	lux	44500	15200	7730	4910
		fc	4140	1410	718	456
	With Reflector GR45 (45°)	lux	20500	7470	3990	2620
		fc	1910	694	371	243
	With Reflector GR60 (60°)	lux	11600	4430	2480	1660
		fc	1070	411	230	155
With Frensel Lens GF14 (Spot)	lux	54500	18100	8650	4670	
	fc	5060	1680	804	434	
With Frensel Lens GF14 (Flood)	lux	18500	7040	3830	2330	
	fc	1720	654	356	216	

CCT	Condition	Unit	3m	5m	7m	9m
8500K	Bare Light	lux	4570	1910	1130	728
		fc	424	178	105	68
	With Reflector GR15 (15°)	lux	89400	29900	14800	9040
		fc	8300	2780	1370	840
	With Reflector GR30 (30°)	lux	40400	13800	7010	4450
		fc	3760	1280	651	413
	With Reflector GR45 (45°)	lux	18600	6780	3630	2380
		fc	1730	630	337	221
	With Reflector GR60 (60°)	lux	10500	4020	2260	1510
		fc	977	374	210	140
	With Frensel Lens GF14 (Spot)	lux	49400	16400	7820	4230
		fc	4590	1530	726	393
With Frensel Lens GF14 (Flood)	lux	16800	6410	3480	2090	
	fc	1560	595	323	195	
10000K	Bare Light	lux	4370	1850	1090	700
		fc	406	172	101	65
	With Reflector GR15 (15°)	lux	85500	28800	14200	8680
		fc	7940	2670	1320	807
	With Reflector GR30 (30°)	lux	38600	13200	6720	4270
		fc	3590	1230	624	396
	With Reflector GR45 (45°)	lux	17900	6520	3480	2290
		fc	1660	606	324	212
	With Reflector GR60 (60°)	lux	10100	3860	2170	1450
		fc	937	359	201	135
	With Frensel Lens GF14 (Spot)	lux	47500	15800	7510	4070
		fc	4410	1470	698	378
	With Frensel Lens GF14 (Flood)	lux	16100	6140	3330	2030
		fc	1500	571	310	189

CCT	Condition	Unit	3m	5m	7m	9m
Red	Bare Light	lux	775	329	199	127
		fc	72	31	19	12
	With Reflector GR15 (15°)	lux	14800	4900	2460	1500
		fc	1380	455	229	140
	With Reflector GR30 (30°)	lux	6620	2280	1190	738
		fc	615	212	111	69
	With Reflector GR45 (45°)	lux	3090	1120	621	410
		fc	287	106	58	38
	With Reflector GR60 (60°)	lux	1780	687	395	257
		fc	165	64	38	24
	With Frensel Lens GF14 (Spot)	lux	8320	2800	1330	696
		fc	773	260	123	65
With Frensel Lens GF14 (Flood)	lux	2670	1040	576	343	
	fc	248	96	54	32	
Green	Bare Light	lux	1470	621	370	241
		fc	137	58	34	22
	With Reflector GR15 (15°)	lux	29100	9710	4790	2920
		fc	2710	902	445	271
	With Reflector GR30 (30°)	lux	13000	4452	2270	1430
		fc	1200	413	211	133
	With Reflector GR45 (45°)	lux	6030	2200	1180	775
		fc	560	204	110	72
	With Reflector GR60 (60°)	lux	3400	1300	735	492
		fc	316	121	68	46
	With Frensel Lens GF14 (Spot)	lux	16000	5350	2550	1360
		fc	1490	497	237	126
With Frensel Lens GF14 (Flood)	lux	5440	2080	1130	688	
	fc	506	193	105	64	
Blue	Bare Light	lux	471	199	119	78
		fc	44	19	11	7
	With Reflector GR15 (15°)	lux	9070	3060	1500	908
		fc	843	284	139	84
	With Reflector GR30 (30°)	lux	4120	1410	719	453
		fc	383	131	67	42
	With Reflector GR45 (45°)	lux	1910	693	375	244
		fc	177	64	35	23
	With Reflector GR60 (60°)	lux	1080	414	235	156
		fc	100	39	22	15
	With Frensel Lens GF14 (Spot)	lux	5020	1670	803	430
		fc	467	155	75	40
With Frensel Lens GF14 (Flood)	lux	1740	667	362	222	
	fc	162	62	34	21	

Illuminance Data (High-speed Mode)

CCT	Condition	Unit	3m	5m	7m	9m
1800K	Bare Light	lux	1360	596	327	181
		fc	126	55	30	17
	With Reflector GR15 (15°)	lux	23900	8370	4330	2530
		fc	2220	778	402	235
	With Reflector GR30 (30°)	lux	11900	4250	2170	1310
		fc	1100	395	201	122
	With Reflector GR45 (45°)	lux	5460	2070	1100	701
		fc	507	192	102	65
	With Reflector GR60 (60°)	lux	3140	1210	665	420
		fc	292	112	62	39
	With Frensel Lens GF14 (Spot)	lux	14600	4960	2470	1320
		fc	1360	461	230	122
With Frensel Lens GF14 (Flood)	lux	4780	1890	1030	659	
	fc	444	175	95	61	
2800K	Bare Light	lux	6220	2630	1480	842
		fc	578	245	138	78
	With Reflector GR15 (15°)	lux	114000	38300	20000	11500
		fc	10600	3560	1860	1070
	With Reflector GR30 (30°)	lux	54100	19400	9770	5850
		fc	5022	1800	907	543
	With Reflector GR45 (45°)	lux	23200	7960	4840	3110
		fc	2160	739	450	288
	With Reflector GR60 (60°)	lux	14200	5420	2920	1920
		fc	1320	503	271	178
	With Frensel Lens GF14 (Spot)	lux	65700	22100	11100	6750
		fc	6100	2060	1030	627
With Frensel Lens GF14 (Flood)	lux	22000	8250	4610	2990	
	fc	2040	766	428	278	
3200K	Bare Light	lux	6520	2790	1550	950
		fc	606	259	144	88
	With Reflector GR15 (15°)	lux	122000	42000	21500	12800
		fc	11300	3900	1990	1190
	With Reflector GR30 (30°)	lux	57900	19100	10300	6240
		fc	5380	1780	956	579
	With Reflector GR45 (45°)	lux	26200	9410	5140	3240
		fc	2430	874	478	301
	With Reflector GR60 (60°)	lux	14900	5740	3120	2030
		fc	1390	534	290	188
	With Frensel Lens GF14 (Spot)	lux	70200	23700	11700	7070
		fc	6520	2200	1080	657
With Frensel Lens GF14 (Flood)	lux	23600	8900	1080	3140	
	fc	2190	827	453	292	

CCT	Condition	Unit	3m	5m	7m	9m
4300K	Bare Light	lux	6300	2680	1500	952
		fc	585	249	140	88
	With Reflector GR15 (15°)	lux	122000	41900	21100	12700
		fc	11300	3890	1960	1180
	With Reflector GR30 (30°)	lux	56100	19000	9870	6060
		fc	5210	1770	917	563
	With Reflector GR45 (45°)	lux	25300	9330	4970	3140
		fc	2350	867	461	292
	With Reflector GR60 (60°)	lux	14500	5540	3010	1950
		fc	1350	514	280	182
	With Frensel Lens GF14 (Spot)	lux	67700	22800	11200	6800
		fc	6290	2120	1040	632
With Frensel Lens GF14 (Flood)	lux	23000	8770	4720	3040	
	fc	2140	815	438	282	
5600K	Bare Light	lux	6020	2570	1430	917
		fc	559	238	133	85
	With Reflector GR15 (15°)	lux	118000	40400	20300	12200
		fc	10900	3750	1890	1130
	With Reflector GR30 (30°)	lux	53900	18300	9490	5800
		fc	5010	1700	882	539
	With Reflector GR45 (45°)	lux	24400	9000	4760	3010
		fc	2260	836	443	279
	With Reflector GR60 (60°)	lux	13900	5360	2880	1880
		fc	1290	498	268	174
	With Frensel Lens GF14 (Spot)	lux	64800	21900	10800	6510
		fc	6020	2040	1000	604
With Frensel Lens GF14 (Flood)	lux	22100	8400	4530	2910	
	fc	2050	780	421	270	
6500K	Bare Light	lux	5380	2290	1280	821
		fc	500	213	119	76
	With Reflector GR15 (15°)	lux	106000	36300	18200	11000
		fc	9800	3370	1690	1020
	With Reflector GR30 (30°)	lux	48100	16500	8440	5180
		fc	4470	1530	784	481
	With Reflector GR45 (45°)	lux	22000	8060	4250	2690
		fc	2040	749	395	250
	With Reflector GR60 (60°)	lux	12400	4780	2570	1670
		fc	1160	444	239	156
	With Frensel Lens GF14 (Spot)	lux	58000	19500	9570	5780
		fc	5390	1810	889	537
With Frensel Lens GF14 (Flood)	lux	19800	7520	4040	2590	
	fc	1840	699	375	241	

CCT	Condition	Unit	3m	5m	7m	9m
8500K	Bare Light	lux	4610	1940	1150	735
		fc	428	181	107	69
	With Reflector GR15 (15°)	lux	90400	31000	15600	9370
		fc	8400	2880	1450	871
	With Reflector GR30 (30°)	lux	41100	14100	7200	4580
		fc	3820	1310	669	425
	With Reflector GR45 (45°)	lux	18800	6900	3660	2410
		fc	1750	641	340	224
	With Reflector GR60 (60°)	lux	10600	4080	2290	1530
		fc	989	379	213	142
With Frensel Lens GF14 (Spot)	lux	49500	16700	8160	4940	
	fc	4600	1550	758	459	
With Frensel Lens GF14 (Flood)	lux	16900	6440	3500	2150	
	fc	1570	598	325	201	
10000K	Bare Light	lux	4410	1890	1115	710
		fc	409	176	104	66
	With Reflector GR15 (15°)	lux	86900	29800	15000	9020
		fc	8070	2770	1390	838
	With Reflector GR30 (30°)	lux	39500	13600	6920	4310
		fc	3670	1260	643	396
	With Reflector GR45 (45°)	lux	18100	6640	3500	2220
		fc	1680	617	325	207
	With Reflector GR60 (60°)	lux	10200	3930	2210	1510
		fc	951	366	205	141
	With Frensel Lens GF14 (Spot)	lux	47600	16100	7860	4740
		fc	4420	1490	730	441
	With Frensel Lens GF14 (Flood)	lux	16300	6210	3350	2140
		fc	1510	577	311	199

CCT	Condition	Unit	3m	5m	7m	9m	
Red	Bare Light	lux	782	324	190	128	
		fc	73	30	18	11	
	With Reflector GR15 (15°)	lux	14800	4890	2440	1450	
		fc	1380	455	227	135	
	With Reflector GR30 (30°)	lux	6690	2420	1230	747	
		fc	621	225	114	69	
	With Reflector GR45 (45°)	lux	3070	1140	623	403	
		fc	285	108	58	37	
	With Reflector GR60 (60°)	lux	1780	682	382	248	
		fc	165	63	36	23	
	With Frensel Lens GF14 (Spot)	lux	8360	2820	1410	702	
		fc	777	262	131	66	
With Frensel Lens GF14 (Flood)	lux	2650	1050	575	352		
	fc	246	98	53	33		
Green	Bare Light	lux	1470	621	350	229	
		fc	137	58	33	21	
	With Reflector GR15 (15°)	lux	29300	9680	4750	2870	
		fc	2720	899	441	266	
	With Reflector GR30 (30°)	lux	13100	4490	2300	1410	
		fc	1210	417	214	131	
	With Reflector GR45 (45°)	lux	6040	2230	1170	769	
		fc	561	207	109	71	
	With Reflector GR60 (60°)	lux	3410	1310	724	481	
		fc	317	121	67	45	
	With Frensel Lens GF14 (Spot)	lux	15900	5370	2580	1390	
		fc	1481	499	239	129	
	With Frensel Lens GF14 (Flood)	lux	5410	2070	1110	698	
		fc	503	192	103	65	
	Blue	Bare Light	lux	472	196	110	74
			fc	44	18	10	7
With Reflector GR15 (15°)		lux	9110	2940	1450	884	
		fc	846	273	135	82	
With Reflector GR30 (30°)		lux	4170	1440	724	448	
		fc	387	133	67	41	
With Reflector GR45 (45°)		lux	1920	703	368	233	
		fc	178	65	34	22	
With Reflector GR60 (60°)		lux	1100	417	224	147	
		fc	102	39	21	14	
With Frensel Lens GF14 (Spot)		lux	5040	1690	817	446	
		fc	468	157	76	41	
With Frensel Lens GF14 (Flood)		lux	1740	684	352	229	
		fc	162	64	33	21	

All the data are average values instead of absolute values. All the above tests are based on the condition of 100% brightness.

Reflector GR15, reflector GR30, reflector GR60 and fresnel lens GF14 are all sold separately.

Technical Data

Model	MG1200R
Power Supply	100V-240V~60/50Hz
Input Power	1600W
CCT	1800-10000K
Brightness Range	0% -100%
Dimming Curves	linear, S-curve, exponential, logarithmic
FX Modes	14
Average CRI	≥96(2800-10000K)
Average TLCI	≥95(2800-10000K)
Waterproof Grade of Light Body/Controller	IP54
Controlling Methods	DMX 512 Control(support RDM protocol) /LumenRadio CRMX Control /Bluetooth APP Control /Ethernet (support Art-Net & sACN protocol)/Remove Controller/Light Body Control (Remove Controller is sold separately)
Bluetooth Controlling Distance	Max. 40m
U-type Bracket Angle	360°
Type-A USB Port	Firmware Upgrade/5V= 1.5A Power Supply
Dimension≈	Light Body (including U-type Bracket) : 15.75" × 23.19"× 13.35" Controller: 7.44" × 6.85" × 15.91"
Netweight≈	Light Body (excluding U-type bracket and reflector) : 9.8kg Controller: 6.7kg

Specifications and data may subject to changes without notice.

FCC Statement

This device complies with part 15 of the FCC Rules. Operation is subject to the following two conditions:

- (1) This device may not cause harmful interference, and
- (2) this device must accept any interference received, including interference that may cause undesired operation.

Any Changes or modifications not expressly approved by the party responsible for compliance could void the user's authority to operate the equipment.

Note: This equipment has been tested and found to comply with the limits for a Class B digital device, pursuant to part 15 of the FCC Rules. These limits are designed to provide reasonable protection against harmful interference in a residential installation. This equipment generates uses and can radiate radio frequency energy and, if not installed and used in accordance with the instructions, may cause harmful interference to radio communications. However, there is no guarantee that interference will not occur in a particular installation. If this equipment does cause harmful interference to radio or television reception, which can be determined by turning the equipment off and on, the user is encouraged to try to correct the interference by one or more of the following measures:

- Reorient or relocate the receiving antenna.
- Increase the separation between the equipment and receiver.
- Connect the equipment into an outlet on a circuit different from that to which the receiver is connected.
- Consult the dealer or an experienced radio/TV technician for help.

The device has been evaluated to meet general RF exposure requirement.
The device can be used in portable exposure condition without restriction.

IC Warning

Le présent appareil est conforme aux CNR d'Industrie Canada applicables aux appareils radio exempts de licence. L'exploitation est autorisée aux deux conditions suivantes:

- (1) l'appareil ne doit pas produire de brouillage, et
- (2) l'utilisateur de l'appareil doit accepter tout brouillage radioélectrique subi, même si le brouillage est susceptible d'en compromettre le fonctionnement

Tout changement ou modification non expressément approuvé par la partie responsable de la réglementation de l'OCDE peut faire perdre à l'utilisateur le droit d'utiliser l'appareil.

Remarque: cet appareil a été testé pour répondre aux limites des appareils numériques de classe B conformément à la partie 15 des règles de la Federal Communications Commission des États - Unis. Ces limites sont conçues pour fournir une protection raisonnable contre les interférences nuisibles dans les installations résidentielles. L'appareil génère de l'énergie RF utilisée et rayonne, ce qui peut causer des interférences nocives pour les communications radio s'il n'est pas installé et utilisé conformément aux instructions. Cependant, aucun

Garantie contre les interférences dans une installation spécifique. Si l'appareil cause des interférences nuisibles à la réception de la radio ou de la télévision, qui peuvent être déterminées en éteignant et en allumant l'appareil, l'utilisateur est encouragé à tenter de corriger les interférences par une ou plusieurs des mesures suivantes:

- redirection ou repositionnement de l'antenne de réception.
- augmenter l'espacement entre l'appareil et le récepteur.
- Connecter l'appareil à une prise sur un circuit différent de celui auquel le récepteur est connecté.
- consultez votre revendeur ou un technicien radio / tv expérimenté pour obtenir de l'aide.

Avertissement RF pour les appareils portables:

L'appareil a été évalué pour répondre aux exigences générales d'exposition aux radiofréquences. Équipement Peut être utilisé sans restriction dans des conditions d'exposition portables.

Warning

Operating frequency:2402MHz – 2480MHz (BT/CRMX)

Maximum EIRP Power: 0.3dBm(BT) / 3.67dBm(CRMX)

Declaration of Conformity

GODOX Photo Equipment Co.,Ltd. hereby declares that this equipment are in compliance with the essential requirements and other relevant provisions of Directive 2014/53/EU. In accordance with Article 10(2) and Article 10(10), this product is allowed to be used in all EU member states.For more information of DoC, Please click this web link:

<https://www.godox.com/eu-declaration-of-conformity/>

The device complies with RF specifications when the device used at 0mm from your body.

产品保修

尊敬的用户, 本保修卡是申请保修服务的重要凭证, 请您配合销售商填写并妥善保管, 谢谢!

产品信息	型号	产品条码
用户信息	姓名	联系电话
	通信地址	
销售商信息	名称	
	联系电话	
	通信地址	
	销售日期	
备注		

注: 此表应由销售商盖章确认。

产品信息

本文件适用于相关《产品保修信息》(见后面说明)所列产品,其他非属此范围的产品或部件(如促销品、赠品及其他出厂后附加的部件等)不在此保修承诺内。

保修期

产品及部件的相应保修期按相关的《产品保修信息》执行。保修期自产品首次购买日起算, 购买日以购买产品时保修卡登记日期为准。

如何获得保修服务

您可直接与产品销售商或授权服务机构联系, 也可拨打神牛产品售后服务电话, 与我们联系, 由我们的服务人员为您安排服务。申请保修时, 您应提供有效的保修卡作为保修凭证, 方可获得保修。如您不能提供有效的保修卡, 则在我们确认产品或部件属于保修范围的情况下, 也可以为您提供保修, 但这不作为我们的义务。

不适用保修情况

如产品存在下列情况，本文件项下的保证和服务将不适用：①产品或部件超过相应保修期；②错误或不当使用、维护或保管导致的故障或损坏，如：不当搬运；非按产品合理预期用途使用；不当插拔外接设备；跌落或外力挤压；接触或暴露于不适当温度、溶剂、酸碱、水浸或潮湿环境；③由非神牛授权机构或人员安装、修理、更改、添加或拆卸造成的故障或损坏；④产品或部件原有识别信息被修改变更或删除；⑤无有效保修卡；⑥使用非合法授权、非标准或非公开发行的软件造成的故障或损坏；⑦因不可抗力或意外事件造成的故障或损坏；⑧其他非因产品本身质量问题导致的故障或损坏。遇上述情况，您应向相关责任方寻求解决，神牛对此不承担任何责任。因非在保修期或保修范围内的部件、附件或软件导致产品不能正常使用的，不是保修范围内的故障。产品使用过程中正常的脱色、磨损和消耗，不是保修范围内的故障。

产品保修和服务支持信息

产品的保修期和服务类型按以下《产品保修信息》执行：

产品类别	选件名称	保修期(月)	保修服务类型
部件	电路板	12	客户送修
	电池	3	客户送修
	充电器等带电性能的部件。	12	客户送修
其他	如外壳、保护罩、锁紧装置、包装等。	无	无保修

神牛产品售后服务电话 0755-29609320-8062

Warranty

Dear customers, as this warranty card is an important certificate to apply for our maintenance service, please fill in the following form in coordination with the seller and safe-keep it. Thank you!

Product Information	Model	Product Code Number
Customer Information	Name	Contact Number
	Address	
Seller Information	Name	
	Contact Number	
	Address	
	Date of Sale	
Note		

Note: This form shall be sealed by the seller.

Applicable Products

Applicable ProductsThe document applies to the products listed on the Product Maintenance Information (see below for further information). Other products or accessories (e.g. promotional items,giveaways and additional accessories attached,etc.) are not included in this warranty scope.

Warranty Period

The warranty period of products and accessories is implemented according to the relevant Product Maintenance Information. The warranty period is calculated from the day(purchase date) when the product is bought for the first time,And the purchase date is considered as the date registered onthe warranty card when buying the product.

How to Get the Maintenance Service

If maintenance service is needed, you can directly contact the product distributor or authorized service institutions. You can also contact the Godox after-sale service call and we will offer you service. When applying for maintenance service, you should provide valid warranty card. If you cannot provide valid warranty card, we may offer you maintenance service once confirmed that the product or accessory is involved in the maintenance scope, but that shall not be considered as our obligation.

Inapplicable Cases

The guarantee and service offered by this document are not applicable in the following cases: ① The product or accessory has expired its warranty period; ② Breakage or damage caused by inappropriate usage, maintenance or preservation, such as improper packing, improper usage, improper plugging in/out external equipment, falling off or squeezing by external force, contacting or exposing to the improper temperature, solvent, acid, base, flooding and damp environments, etc; ③ Breakage or damage caused by non-authorized institution or staff in the process of installation, maintenance, alternation, addition and detachment; ④ The original identifying information of product or accessory is modified, alternated, or removed; ⑤ No valid warranty card; ⑥ Breakage or damage caused by using illegally authorized, nonstandard or non-public released software; ⑦ Breakage or damage caused by force majeure or accident; ⑧ Breakage or damage that could not be attributed to the product itself. Once met these situations above, you should seek solutions from the related responsible parties and Godox assumes no responsibility. The damage caused by parts, accessories and software that beyond the warranty period or scope is not included in our maintenance scope. The normal discoloration, abrasion and consumption are not the breakage within the maintenance scope.

Maintenance and Service Support Information

The warranty period and service types of products are implemented according to the following Product Maintenance Information:

Product Type	Name	Maintenance Period(month)	Warranty Service Type
Parts	Circuit board	12	Customer sends the product to designated site
	Battery	3	Customer sends the product to designated site
	Electrical parts e.g.battery charger, etc.	3	Customer sends the product to designated site
Other Items	Lamp body, lamp cover, locking device, package, etc.	No	Without warranty

合格证
QC PASS



Wechat
Official Account
神牛微信公众号

深圳市神牛摄影器材有限公司

地址：深圳市宝安区福海街道塘尾社区耀川工业园厂房 2 栋

电话：0755-29609320 (8062) 传真：0755-25723423 邮箱：godox@godox.com

GODOX Photo Equipment Co., Ltd.

Add.: Building 2, Yaochuan Industrial Zone Tangwei Community, Fuhai Street, Bao'an District, Shenzhen

518103, China Tel: +86-755-29609320(8062) Fax: +86-755-25723423 E-mail: godox@godox.com

www.godox.com

Made in China | 705-MG120R-06

