

Godox

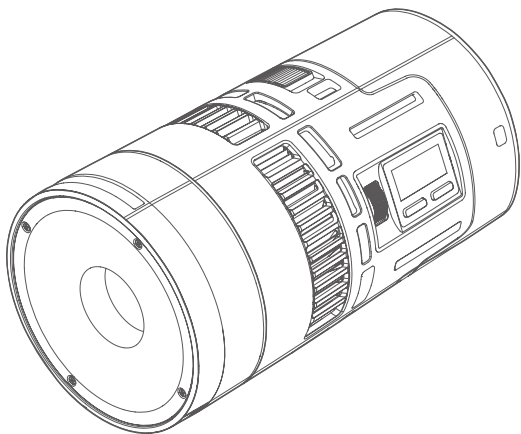

# RS60R

神牛全彩 LED 摄影灯  
Godox Full-color LED Light

使用手册  
Instruction Manual

V1.1 说明书 / Instruction Manual

V1.00 固件 / Firmware

## 重要的安全说明及注意事项

首先作为最基本原则：本产品为专业灯光布景设备，应由专业灯光师使用或在专业人士指导下使用。使用时必须始终遵循基本的安全预防措施，具体安全预防措施如下：

1. 使用前必须阅读并理解产品说明书。
2. 专业灯具，禁止儿童使用。当儿童靠近时，家长或陪护人必须密切监督，以免儿童因碰撞灯具或私用灯具造成人身伤害。
3. 本灯具并非普通照明灯具，不可用于普通照明，任何有过眼部损伤或眼部敏感的人群均应避免使用本灯具。
4. 灯具点亮时，必须小心使用，禁止接触高温部件，如 LED 灯珠，以免造成灼伤。
5. 灯具点亮时，任何情况下均禁止直视灯珠。应该在专业灯光师指导下使用强光，任何情况下避免长时间处于强光环境，如引起眼睛不适，请及时关闭灯具，暂停使用，请及时就医。
6. 倘灯珠损坏或因热变形，应停止使用，并及时联系制造商、服务代理商或合格的维修人员更换灯珠，以免发生意外。
7. 本产品仅适用于  $-20^{\circ}\text{C} \sim 40^{\circ}\text{C}$  工作环境温度及正常湿度环境下使用。
8. 请勿使用损坏的设备或设备配件，待专业维修人员检查维修，确认设备正常方可使用。
9. 在使用过程中，如果本产品由于跌落、受到挤压或遭受强烈冲击而造成外壳破裂的，请勿继续使用，以免因接触到内部电子元件而受到电击伤害。
10. 如需要延长线，请使用额定电流  $\geq$  该设备额定电流的延长线。如延长线额定电流小于该设备，可能导致过热。
11. 部分产品电源线较长，请合理放置电源线，使其处于安全位置。避免电源线接触过热物体表面、避免放置不当导致拉扯损坏或绊倒现场人员。请使用本厂原装电源线，如使用非本厂电源线导致产品损坏，一概不在本厂维修范围内。
12. 在清洁和维修之前，请务必从电源插座上拔下该设备插头。不使用时，禁止拉扯电源线以将设备插头从电源插座中拔出。正常断电，应是用手抓住该设备插头两端，将插头从电源插座中拔出。此设备需连接到接地插座中。
13. 本设备没有防水性能，请让设备保持干燥，请勿将本设备浸入水中或其他液体中。设备需安装在干燥且通风处，避免在雨天、潮湿、多尘或过热环境下使用。请勿将任何物体置于灯具上或使液体流入灯具内部，以免发生意外。
14. 请勿私自拆卸产品，如产品出现故障，须由本公司或授权的维修人员进行检查维修。
15. 存放本设备之前，请确保设备已完全冷却。存放时，将电源线从设备上拔出。设备应放置于设备便携包内或通风干燥处。
16. 请勿将设备放置在酒精、汽油等易燃易爆挥发的溶剂附近。
17. 本厂不推荐的产品附件，请勿使用，以免导致火灾、触电或人身伤害。
18. 请务必经常清洁灯珠玻璃并使其保持干净，玻璃如粘上蚊虫尸体或深色有机物污渍，可能引起玻璃炸裂；清洁本设备时，请勿用湿布擦拭，请用干燥的软布擦拭设备污垢。

19. 本产品已通过 ROHS, CE 和 FCC 认证, 请参考相关国家标准使用和操作。
20. 安全说明依据本厂严格测试制定, 设备设计和规格如有变更, 恕不另行通知。客户可以上神牛官网查看最新的电子版说明, 了解产品最新资讯。
21. 部分产品内置锂电池, 此类产品请使用专用的充电器进行充电, 并且按正确的操作说明, 在规定的电压、温度范围内使用。
22. 部分产品使用电池供电, 此类产品请勿使用说明书中未指定的任何电池、电源或附件。请将电池和其他附件置于儿童及婴幼儿无法触及之处。如果儿童或婴幼儿吞下电池或附件, 请立刻就医。如果电池漏液、变色、变形、冒烟或发出异味, 请立刻将其取出。在取出过程中请小心, 以免烫伤。如果继续使用, 可能会引起火灾、触电或皮肤烫伤。请勿使用任何变形或改造过的电池。请勿拆卸或改造本产品或电池。请勿加热电池或焊接电池。请勿让电池与火或水接触。请勿让电池受到强烈的外力撞击。请勿将电池的正负极错误插入, 或将新旧电池或不同类型的电池混合使用。
23. 一年保修期, 消耗品电池、适配器、电源线等配件不在此保修范围内。
24. 经发现, 擅自检修设备, 将取消一年保修期, 维修需要收取相关费用。
25. 对于不规范操作引起的机器故障不在保修范围内。



请勿直视光源

AC 电源模组 Type-C 端口仅用于灯具光源供电, 不用于其他产品供电。

本设备包含型号核准代码为: CMIIT ID: 24J44V807298, 为该产品的无线电发射模块。

## 前言

感谢您购买神牛产品!

神牛全新推出全彩 LED 摄影灯 RS60R, RS60R 以全彩光色含多种色彩模式如 CCT/HSI/RGBW/FX 光效, 1800K-10000K 广域双色温, 精确微调的千分级调光, 支持有线 DMX 连接与蓝牙无线控制, 灯珠高亮高显等特性能更好地应对拍摄工作, 适用于采访、直播、短视频、静物拍摄时进行布光。

## 部件名称

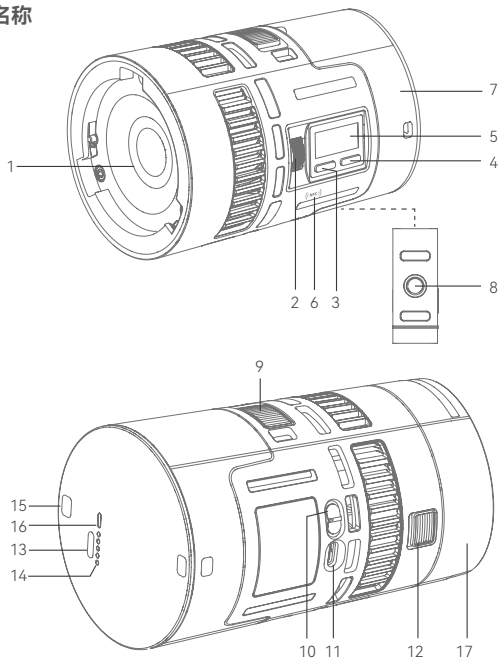

- |                  |                 |
|------------------|-----------------|
| 1. 灯珠            | 10. 开关按键        |
| 2. 调节按钮（滚动 / 按压） | 11. 灯体 USB-C 接口 |
| 3. MODE 按键       | 12. 卡口推制        |
| 4. MENU 按键       | 13. 电池 USB-C 接口 |
| 5. 彩屏            | 14. 电池电量指示灯     |
| 6. NFC 感应区域      | 15. 挂绳孔 *2      |
| 7. 电池            | 16. 电池电量指示灯按键   |
| 8. 1/4"接口        | 17. 透镜反光杯       |
| 9. 电池拆卸推制        |                 |



## RS60R 物品清单

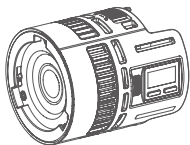

灯体 × 1

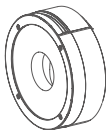

透镜反光杯 × 1



电池 × 1  
(MS60BAT01)

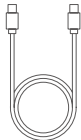

USB-C 充电线 × 1  
(80cm)



转接座 × 1  
(AD-E2)



收纳包 × 1



说明书 × 1

## RS60R 1K 物品清单

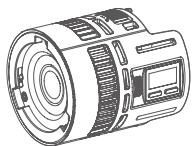

灯体 × 1

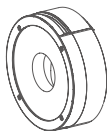

透镜反光杯 × 1

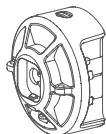

适配电源 × 1  
(MS60PA01)



电源线 × 1



转接座 × 1  
(AD-E2)

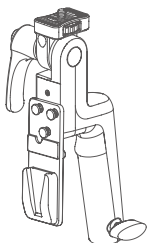

V口电池手柄 × 1



D-TAP线 × 1

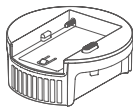

NPF 电池转接板 × 1  
(MS60NPA)

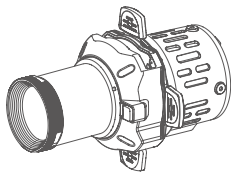

投影筒 × 1  
(SP36K)



收纳包 × 1



说明书 × 1

## RS60R 2K 物品清单

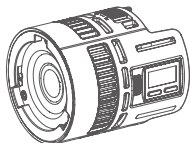

灯体 × 2

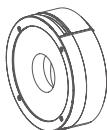

透镜反光杯 × 2



电池 × 2  
(MS60BAT01)

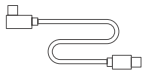

USB-C 充电线 × 2  
(80cm)



适配电源 × 2  
(MS60PA01)



电源线 × 2



转接座 × 2  
(AD-E2)



变焦透镜 × 1  
(SZL2)

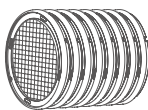
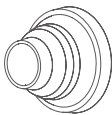
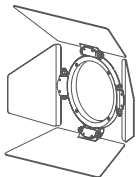

磁吸套件 × 1  
(MK)

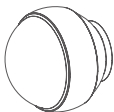

柔光球 × 1  
(SD15)

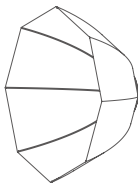

深口柔光箱 1' × 1'  
(SP1)



收纳包 × 1



说明书 × 1

温馨提示：说明书中线图均为示意图，仅供参考。由于产品不断更新与升级，产品实物与线图可能存在差异，请以实物为准。

## 安装 / 拆卸透镜反光杯

**安装：**将透镜反光杯对准灯头卡口插入，再顺时针旋转即可安装完毕。

以透镜反光杯上的 ▲ 标志指向卡口推制，透镜反光杯与灯体侧面的对齐线连成一条，为正确安装。

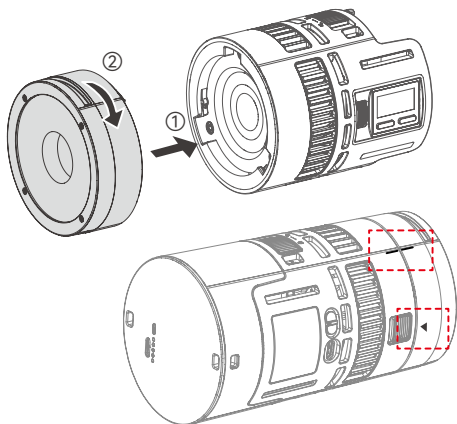

**拆卸：**按住卡口推制，逆时针旋转透镜反光杯即可拆卸完毕。

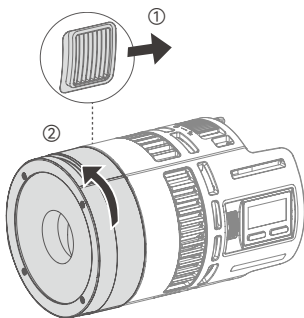

## 安装 / 拆卸转接座 AD-E2

**安装：**灯体上的 1/4" 接口对准螺丝，顺时针滚动锁紧装置，灯体与转接座即安装为一体，再安装于另购的三脚架即可。

**拆卸：**如需拆卸，逆时针滚动锁紧装置，可将灯体取下。

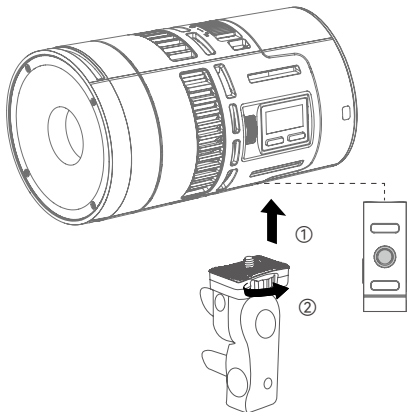

## 电池说明

**安装：**灯体与电池两端的金属触点对齐，将电池卡入槽内向下按压，电池拆卸推制“咔”一声自动锁紧，电池安装完毕。

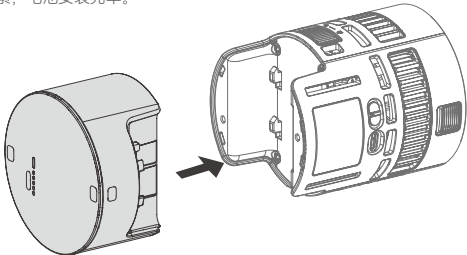

**拆卸：**按住电池拆卸推制，将电池向上拔出即可。

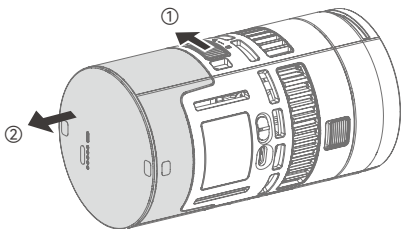

**指示灯：**按下电池电量指示灯按键，可随时查看电池电量。

**电池充电：**电池上设有 USB-C 接口，在灯具关机状态下插入标配的 USB-C 充电线，接入电源可给电池充电，请勿在开机状态下进行充电。

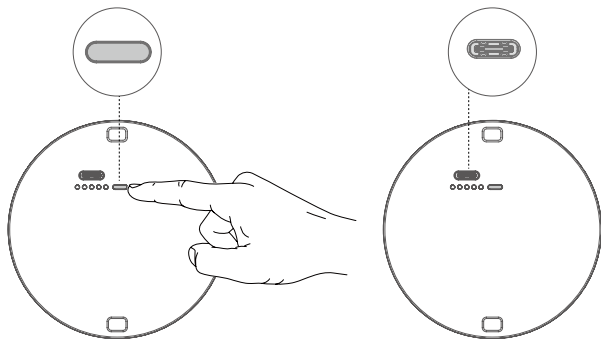

## 灯体 USB-C 口供电

灯体上设有 USB-C 接口，插入标配的 USB-C 充电线后，接入电源可给灯具供电，此供电方式无法给电池充电。

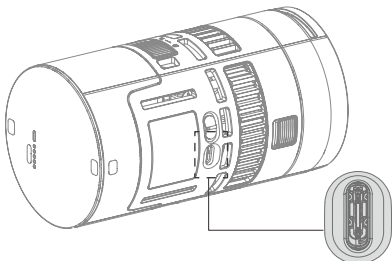

注：需使用 > 60W 的供电设备

## 有线 DMX 连接

灯体 USB-C 接口插入 DMX 转接线 DMX-C1 后灯具即具备 DMX 输出口和 DMX 输入口，再使用 DMX 连接线连接控制台并串联灯具，进行有线 DMX 连接。

注：上文提到的 DMX 转接线 DMX-C1、DMX 控制台、DMX 连接线皆为另购物品。



## 套装 / 另购附件

以下列举的附件为另购附件或不同套装中内含的附件，是否含有以下附件请查看实际购买的物品清单。



电源线

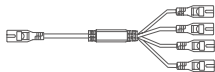

1拖4电源线

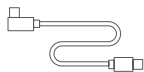

USB-C 充电线 (20cm)

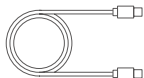

USB-C 充电线 (80cm)



反光罩 SR15

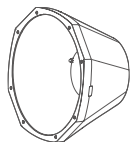

回光灯反光罩  
BeamLight S20

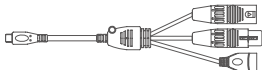

DMX 转接线 DMX-C1

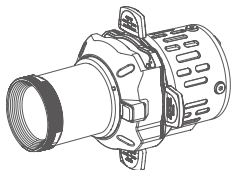

投影筒 SP36K

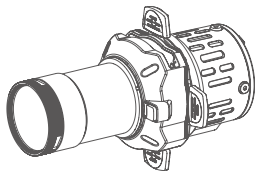

投影筒 SP50K

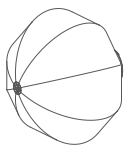

球形柔光罩 SL1

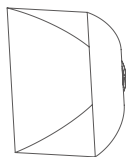

四角柔光箱 SS11

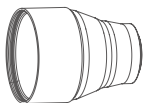

聚光镜 DL5 Lite

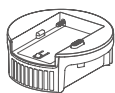

NPF 电池转接板  
MS60NPA



束光筒 AK-SN

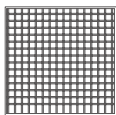

格栅 SS11G

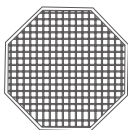

格栅 SP1G

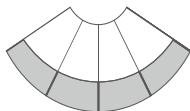

裙边 SL1S

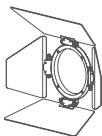

四叶挡板 AK-B4

## 适配电源 MS60PA01

1. 灯体与适配电源两端的金属触点对齐，将适配电源卡入槽内向下按压，电池拆卸推制“咔”一声自动锁紧即安装完毕。
2. 如需拆卸，按住电池拆卸推制的同时将适配电源向上拔出即可。
3. 适配电源上设有 8 字电源插座，通过 8 字电源线连接，接入电源可给灯具供电。

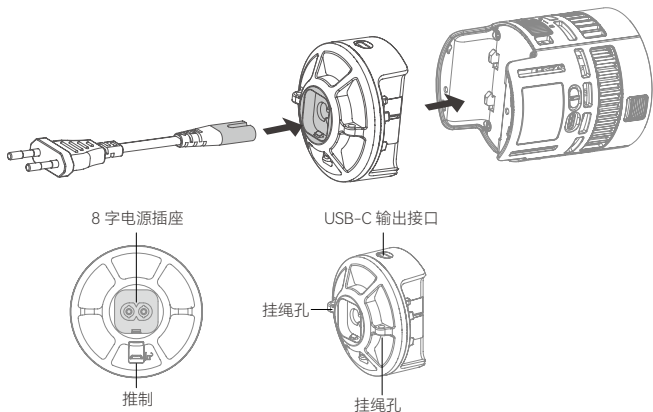

## 变焦透镜 SZL2

1. 实现光束变焦，调节范围  $15^{\circ} \sim 30^{\circ}$ 。
2. 将 SZL2 对准灯头卡口插入，顺时针旋转即可安装完毕。
3. 如需拆卸，按住卡口推制，逆时针旋转 SZL2 即可。

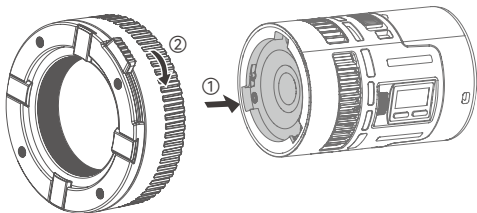

## 磁吸套件 MK

1. 束光筒、变形片配合透镜反光杯使用；束光筒也可在裸灯上使用，套于灯头卡口即可。
2. 四叶挡板、半球扩散罩配合磁吸转接环使用。
3. 磁吸转接环安装：将磁吸转接环对准灯头卡口插入后顺时针旋转，卡口推制自动锁紧即安装完毕。

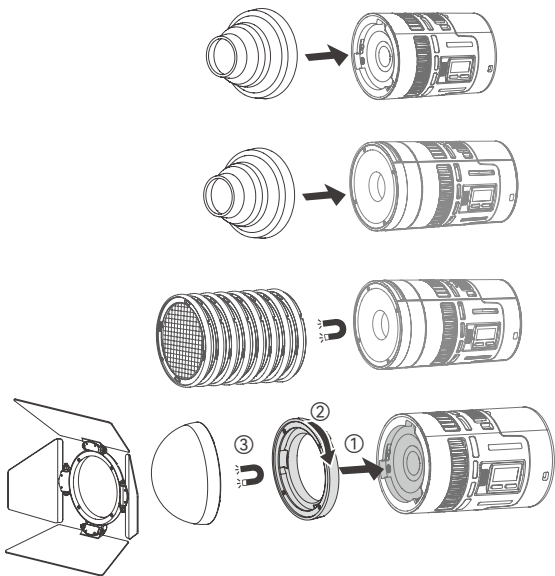

## NPF 电池转接板 MS60NPA

1. **重要说明：**请确保另购电池的带载能力 $\geq 70\text{W}$ ，以保证灯具在高亮度模式下正常工作。或者可以降低灯具的亮度输出，减轻电池负载，避免因超载而触发自动关机。
2. 灯体与 MS60NPA 两端的金属触点对齐，将 MS60NPA 卡入槽内向下按压，电池拆卸推制“咔”一声自动锁紧即安装完毕，另购电池装入 MS60NPA 即可。
3. 如需拆卸，按住电池拆卸推制的同时将 MS60NPA 向上拔出即可。
4. 转接板上设有 DC 口，插入另购的转接线与 14.8V 的 V 口电池连接，可进行 V 口电池供电。

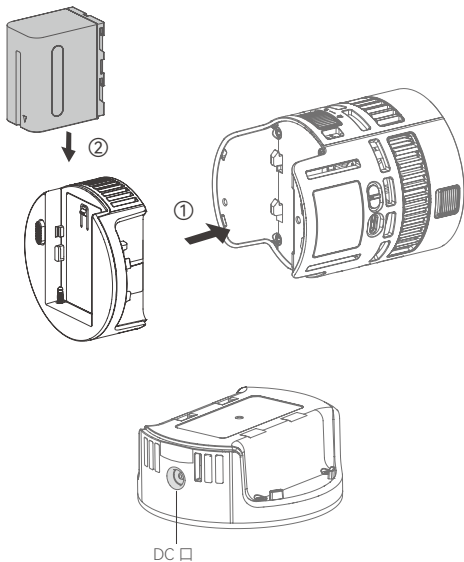

## 深口柔光箱 SP1

1. 先将柔光箱安装在卡盘上,内侧有魔术贴可粘贴上外白布与格栅,将深口柔光箱 SP1 组装好。
2. 将组装好的 SP1 对准灯头卡口插入,顺时针旋转即可安装完毕。
3. 如需拆卸,按住卡口推制,逆时针旋转 SP1 即可。

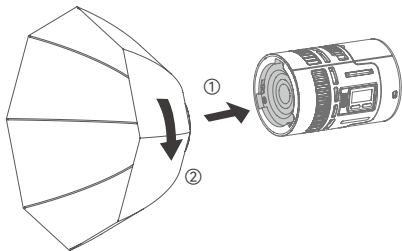

## 柔光球 SD15

1. 转接环设计为 一面平整另一面有凹槽,将平整面套进柔光球内组装好,外露的凹槽面对准灯头卡口插入再顺时针旋转,卡口推制自动锁紧。
2. 如需拆卸,按住卡口推制,逆时针旋转柔光球即可。

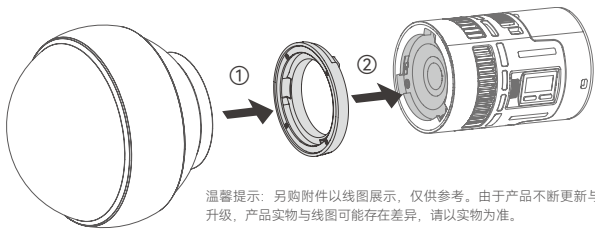

温馨提示: 另购附件以线图展示,仅供参考。由于产品不断更新与升级,产品实物与线图可能存在差异,请以实物为准。

## 开关机

接通电源后拨动开关按键至 ON 实现开机,拨动至 OFF 实现关机,灯具内设防误触功能,可在菜单内找到该项,设置开启或关闭。

## 模式选择

短按 MODE 按键进入模式选择，滚动调节按钮可选图中任意一种模式，短按调节按钮进入该模式的具体设置。通过短按并滚动调节按钮设置参数值，向上滚动递增参数值，向下滚动递减参数值。

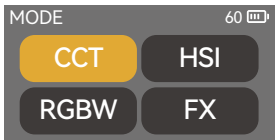

## CCT 模式

短按 MODE 按键进入模式选择，选中 CCT 后短按调节按钮进入该模式，可选亮度 / 色温 / GM。

亮度范围：0% ~ 100%

色温范围：1800K ~ 10000K

GM 范围：-100% ~ +100%

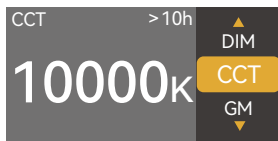

## HSI 模式

短按 MODE 按键进入模式选择，选中 HSI 后短按调节按钮进入该模式，可选亮度 / 色相 / 饱和度。

亮度范围：0% ~ 100%

色相范围：0° ~ 360°

饱和度范围：0% ~ 100%

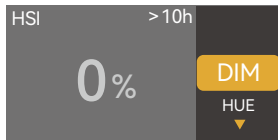

## RGBW 模式

短按 MODE 按键进入模式选择，选中 RGBW 后短按调节按钮进入该模式，可选亮度 / 红光 / 绿光 / 蓝光 / 白光。

亮度范围：0% ~ 100%

红光范围：0% ~ 100%

绿光范围：0% ~ 100%

蓝光范围：0% ~ 100%

白光范围：0% ~ 100%

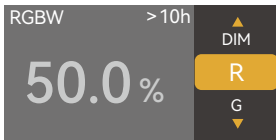

## FX 模式

短按 MODE 按键进入模式选择，选中 FX 后短按调节按钮进入该模式，可选光效有以下 14 类。

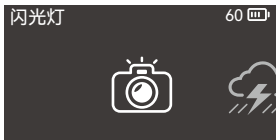

### 1. 闪光灯

此光效模拟闪光灯闪光或传统镁光灯闪光，常用于营造一种生动、活泼的氛围。

开关：开启 / 关闭

亮度：0% -100%（以 0.1% 为增量）

颜色：CCT/HSI

色温 / 色相：1800K-10000K/0-360°

速度：1-100

模式：闪光灯 / 镁光灯

触发：自动 / 手动

### 2. 雷闪电

此光效模拟雷电的闪电，常用于营造一种紧张、恐怖或神秘的氛围。

开关：开启 / 关闭

亮度：0% -100%（以 0.1% 为增量）

色温：1800K-10000K

闪烁次数：随机 / 1-10

频率：随机 / 2-20

触发：自动 / 手动



### 3. 多云

此光效模拟云层遮挡效果，常用于营造一种阴沉、压抑或悲伤氛围。

开关：开启 / 关闭

亮度：0% -100%（以 0.1%为增量）

亮暗比例：30%-90%

速度：随机 /1-100

### 4. 坏灯泡

此光效模拟一盏损坏的灯泡闪光，常用于营造昏黄的环境氛围。

开关：开启 / 关闭

亮度：0% -100%（以 0.1%为增量）

颜色：CCT/HSI

色温 / 色相：1800K-10000K/0-360°

速度：1-100

### 5. 电视机

此光效模拟电视机或屏幕的光线效果，常用于营造出一种冷淡、机械或数字化的氛围。

开关：开启 / 关闭

亮度：0% -100%（以 0.1%为增量）

颜色：CCT/HSI

速度：1-100

### 6. 蜡烛

此光效模拟蜡烛的光线效果，常用于营造出一种柔和、温暖、闪烁的氛围。

开关：开启 / 关闭

亮度：0% -100%（以 0.1%为增量）

速度：1-100

### 7. 火

此光效模拟火焰的光线效果，常用于营造出一种明亮、热烈、闪烁氛围。

开关：开启 / 关闭

亮度：0% -100%（以 0.1%为增量）

速度：1-100

## 8. 烟花

此光效模拟烟花的光线效果，常用于营造出一种绚丽、多彩、浪漫的氛围。

开关：开启 / 关闭

亮度：0% -100%（以 0.1%为增量）

余烬：1-100

速度：1-100

## 9. 爆炸

此光效模拟爆炸的光线效果，常用于营造出一种明亮、猛烈、闪烁氛围。

开关：开启 / 关闭

亮度：0% -100%（以 0.1%为增量）

颜色：CCT/HSI

色温 / 色相：1800K-10000K/0-360°

余烬：1-100

速度：1-100

触发：自动 / 手动

## 10. 焊接

此光效模拟焊接的光线效果，常用于营造出一种炽热、机械的氛围。

开关：开启 / 关闭

亮度：0% -100%（以 0.1%为增量）

颜色：CCT/HSI

色温 / 色相：1800K-10000K/0-360°

速度：1-100

## 11. 警车

此光效模拟警车灯光的闪烁效果，常用于营造紧张、追逐或紧张氛围。

开关：开启 / 关闭

亮度：0% -100%（以 0.1%为增量）

颜色：红 + 蓝、红、蓝、蓝 + 白、蓝 + 黄、黄、红 + 白 + 蓝、红 + 黄 + 蓝

模式：1-5

## 12.SOS SOS

此光效模拟 SOS 求救信号的闪烁效果，常用于营造危险、求救或紧急情况氛围。

开关：开启 / 关闭

亮度：0% -100%（以 0.1%为增量）

颜色：CCT/HSI

色温 / 色相：1800K-10000K/0-360°

### 13. 彩光循环

此光效模拟模拟彩色光线的循环和变化效果，常用于营造一种梦幻、科幻的氛围。

开关：开启 / 关闭

亮度：0% -100%（以 0.1%为增量）

饱和度：0%-100%

速度：1-100

### 14. 派对

此光效模拟彩色光线、闪光灯和激光等效果，常用于营造出一种狂欢、欢乐、高能氛围。

开关：开启 / 关闭

亮度：0% -100%（以 0.1%为增量）

饱和度：0%-100%

速度：1-100

注：根据需求滚动调节按钮设置当前参数值，设置完毕后短按并滚动调节按钮可跳入下一栏参数进行设置；选中手动时，通过短按一次调节按钮触发一次该光效；某个光效设置完毕后短按 MODE 按键回到 14 类光效选择界面。

## 菜单设置

短按 MENU 按键进入菜单界面，滚动调节按钮进行选择，选定后短按调节按钮进入该项的具体设置。

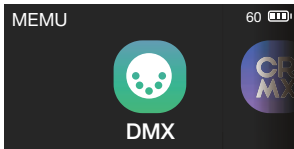

### 1.DMX

短按调节按钮进入 DMX 设置，通过滚动并短按调节按钮设置参数值，如下表所示。

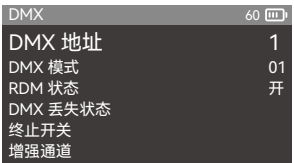

一级选项	二级选项	说明
地址	001-512	起始地址
DMX模式	01: CCT 8Bit	8 位 CCT 模式
	02: HSI 8Bit	8 位 HSI 模式
	03: RGB 8Bit	8 位 RGB 模式
	04: RGBW 8Bit	8 位 RGBW 模式
	05: CCT+HSI 8Bit	8 位 CCT+HSI 模式
	06: CCT+RGBW 8Bit	8 位 CCT+RGBW 模式
	07: FX 8Bit	8 位 FX 模式
	08: CCT 16Bit	16 位 CCT 模式
	09: HSI 16Bit	16 位 HSI 模式
	10: RGB 16Bit	16 位 RGB 模式
	11: RGBW16Bit	16 位 RGBW 模式
	12: FX 16Bit	16 位 FX 模式
	13: ULTIMATE 8Bit	8 位 ULTIMATE DMX 模式
	14: ULTIMATE 16Bit	16 位 ULTIMATE DMX 模式
RDM状态	开启	开启 RDM, 开启后控制台可设置灯具地址及 DMX 模式
	关闭	关闭 RDM
DMX丢失状态	保持最后状态	失去 DMX 控制信号后, 在关机或再次接收有效 DMX 控制信号前, 持续使用最后一次接收的 DMX 控制信号。
	直接关闭	灯具直接熄灭
	保持最后状态2分钟熄灭	失去 DMX 控制信号后, 持续使用最后一次接收的 DMX 控制信号 2 分钟, 2 分钟后灯具熄灭。注: 如 2 分钟内接收到有效 DMX 控制信号, 则使用新的 DMX 控制信号。
终止开关	开启	开启 DMX 终端
	关闭	关闭 DMX 终端
增强通道	开启	开启增强通道信号
	关闭	关闭增强通道信号

注: 使用 DMX/RDM 控制台控制灯具, 可登录官网 <https://www.godox.com.cn/> 下载 DMX 模式表。

## 2. 蓝牙

短按调节按钮进入蓝牙设置，通过短按并滚动调节按钮设置开启或关闭；如需进行重置，滚动调节按钮到重置栏，短按调节按钮可选确定重置或取消重置，选定后短按调节按钮即可；下一栏可查看蓝牙 MAC 码，方便查找灯具。



## “Godox Light”app 下载

扫描二维码即可下载“Godox Light”手机 app（安卓和苹果系统都可以使用）。

注：

1. 首个移动设备（手机或平板电脑）可直接使用 app 操控灯体。更换其他移动设备时，灯体需进行蓝牙重置方可正常使用 app。
2. app 需升级至 V3.0 以上版本。



## “Godox Light”app 固件升级

手机中打开 Godox Light，进入其中一个场景，点击 +（添加设备），设备添加完成后，点击  延伸出多项设置，再选择固件升级即可。

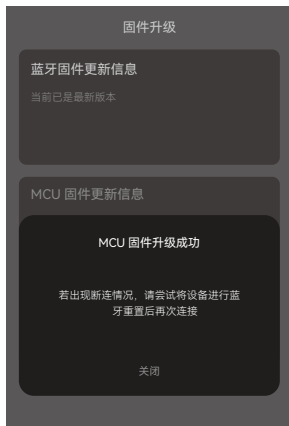

### 3. 调光曲线

短按调节按钮进入调光曲线设置，通过滚动调节按钮可选线性 / S 曲线 / 指数 / 对数，选定后短按调节按钮完成设置。



### 4. 风扇

短按调节按钮进入风扇设置，通过滚动调节按钮可选静音 / 自动 / 中速 / 高速，选定后短按调节按钮完成设置。



### 5. 防误触

短按调节按钮进入防误触设置，通过滚动调节按钮可选开启或关闭，选定后短按调节按钮完成设置；开启防误触后，开机不会立刻进入主界面，屏幕会出现解锁方法，如图所示向下滚动调节按钮即可进入主界面。



## 6. 屏幕设置

短按调节按钮进入屏幕设置，通过滚动调节按钮设置 10%-100% 屏幕亮度。

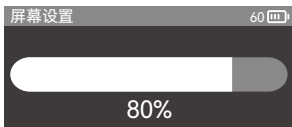

## 7. 语言

短按调节按钮进入语言设置，通过滚动调节按钮可选简体中文 /English，选定后短按调节按钮完成设置。



## 8. 恢复出厂设置

短按调节按钮进入恢复出厂设置，通过滚动调节按钮可选确定 / 取消，当您短按调节按钮确定恢复出厂，灯具将自动重启，界面会出现简体中文和 English 选项，设置您需要的语言后灯体亮度值自动变为 100% 且界面来到 CCT 模式。



## 9. 灯具信息

短按调节按钮进入灯具信息，此界面可查看如图示内容。

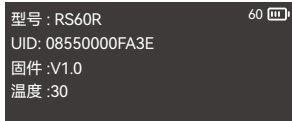

## NFC 加灯

通过手机 NFC 功能与灯具 NFC 芯片相互通信后完成快速添加灯具到【Godox light】App 中。

1、前置条件：灯具支持 NFC 添加、【Godox light】App 版本 V3.2.4 以上、手机开启蓝牙和 NFC 功能。

2、使用方法：前置条件成立情况下，打开【Godox light】进入对应场景中，点击【+】选择【NFC 加灯】功能，进入【NFC 添加设备】页面将手机 NFC 感应区靠近灯具感应区即可完成加灯，支持多灯添加。

注意：Android 系统直接靠近感应加灯，iOS 需点击右上角（）图标后出现弹窗感应加灯。

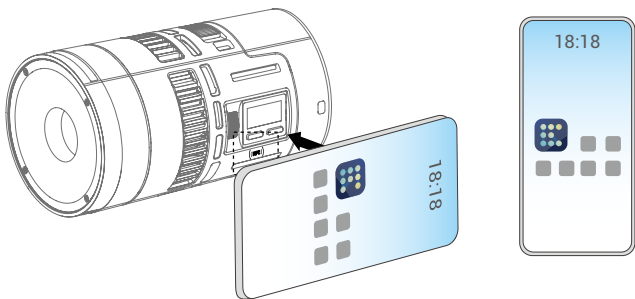



## 照度数据

色温	测试条件	照度单位	1m	2m	3m
1800K	裸灯	lux	≈ 926	≈ 229	≈ 103
		fc	≈ 86	≈ 21	≈ 10
2800K		lux	≈ 1420	≈ 358	≈ 161
		fc	≈ 132	≈ 33	≈ 15
3200K		lux	≈ 1420	≈ 358	≈ 161
		fc	≈ 132	≈ 33	≈ 15
4300K		lux	≈ 1390	≈ 352	≈ 158
		fc	≈ 129	≈ 33	≈ 15
5600K		lux	≈ 1350	≈ 340	≈ 153
		fc	≈ 125	≈ 32	≈ 14
6500K		lux	≈ 1320	≈ 343	≈ 149
		fc	≈ 122	≈ 32	≈ 14
8500K		lux	≈ 1240	≈ 312	≈ 141
		fc	≈ 115	≈ 29	≈ 13
10000K		lux	≈ 1210	≈ 304	≈ 137
		fc	≈ 112	≈ 28	≈ 13
R (红光)	lux	≈ 504	≈ 125	≈ 55	
	fc	≈ 47	≈ 12	≈ 5	
G (绿光)	lux	≈ 773	≈ 196	≈ 88	
	fc	≈ 72	≈ 18	≈ 8	
B (蓝光)	lux	≈ 247	≈ 63	≈ 29	
	fc	≈ 23	≈ 6	≈ 3	

色温	测试条件	照度单位	1m	2m	3m
1800K	带标配 透镜反光杯	lux	≈ 7540	≈ 1700	≈ 733
		fc	≈ 700	≈ 158	≈ 68
2800K		lux	≈ 11400	≈ 2740	≈ 1210
		fc	≈ 1060	≈ 254	≈ 112
3200K		lux	≈ 11400	≈ 2740	≈ 1220
		fc	≈ 1060	≈ 255	≈ 113
4300K		lux	≈ 11300	≈ 2720	≈ 1200
		fc	≈ 1050	≈ 252	≈ 112
5600K		lux	≈ 11000	≈ 2650	≈ 1180
		fc	≈ 1020	≈ 246	≈ 109
6500K		lux	≈ 10800	≈ 2600	≈ 1160
		fc	≈ 1010	≈ 242	≈ 108
8500K	lux	≈ 10200	≈ 2460	≈ 1090	
	fc	≈ 948	≈ 229	≈ 102	
10000K	lux	≈ 10000	≈ 2410	≈ 1070	
	fc	≈ 929	≈ 224	≈ 100	
R (红光)	lux	≈ 4200	≈ 964	≈ 408	
	fc	≈ 390	≈ 90	≈ 38	
G (绿光)	lux	≈ 6480	≈ 1570	≈ 695	
	fc	≈ 602	≈ 146	≈ 65	
B (蓝光)	lux	≈ 2570	≈ 601	≈ 267	
	fc	≈ 239	≈ 56	≈ 25	

以上数据均为平均值，非绝对值，以上测试皆在灯体 100%亮度下进行。

## 规格参数

型号	RS60R
锂电池参数	标称电压 14.4V USB-C Input: 5V $\leq$ 3A, 9V $\leq$ 3A, 12V $\leq$ 2.5A, 20V $\leq$ 1.5A
灯体 USB-C 接口输入	20V $\leq$ 3A Max.60W
色温	1800K-10000K
调光范围	0%-100%
调光曲线	线性 / S 曲线 / 指数 / 对数
FX 光效	14 类
CRI	平均 $\geq$ 95
TLCI	平均 $\geq$ 95
控制方式	有线 DMX 控制, 支持 RDM 协议 / 蓝牙 APP 控制
蓝牙控制距离	60m
工作环境温度	-20°C ~ 40°C
尺寸 (不含透镜反光杯和电池)	$\approx$ 77mm $\times$ 77mm $\times$ 91mm
净重 (不含透镜反光杯和电池)	$\approx$ 311g

设计和规格如有变更, 恕不另行通知。

## Safety Instructions and Attentions

**First of all, as the most basic principle: This product is a professional lighting set equipment and should be used by professional lighting engineers or under the guidance of professionals. Basic safety attentions must always be followed during use, as follows:**

1. Before use, please read and understand these instructions and attentions.
2. Professional lighting is prohibited for children. When children are near, parents or accompanying persons must supervise closely to prevent children from personal injury due to collision with lamps or private use of lamps.
3. This lighting product is not ordinary lighting product and cannot be used for general lighting. Anyone who has suffered eye damage or has sensitive eyes should avoid using this product.
4. When the lamp is on, it must be used with care. Do not touch high-temperature parts, such as LED lamp beads, to avoid burns.
5. When the lamp is on, it is forbidden to look directly at the lamp beads under any circumstances. Strong light should be used under the guidance of professional lighting engineers. Avoid prolonged exposure to strong light under any circumstances. If eye discomfort, please turn off the lamp in time, suspend use, and see a doctor immediately.
6. If the lamp bead is damaged or deformed by heat, stop using this equipment, and contact the manufacturer, service agent or qualified maintenance personnel to replace the lamp bead in time to avoid accidents.
7. This product is only suitable for use in  $-10^{\circ}\text{C}$  to  $40^{\circ}\text{C}$  operating environment and normal humidity environment.
8. Do not use damaged equipment or accessories, and wait for professional maintenance personnel to check and repair to confirm being normal before use.
9. During using, if the casing of this product is broken due to being dropped, squeezed or subjected to strong impact, please do not use it, so as to avoid electric shock injury due to contact with internal electronic components.
10. If an extension cord is required, please use an extension cord with a current rating greater than or equal to that of the equipment. If an extension cord is rated less than the equipment, overheating may result.
11. Some products have long power cords, please place the power cords properly and keep them in a safe place. Avoid contacting the power cord with overheating surfaces, avoid improper placement that could cause pulling damage, or trip on-site personnel. Please use the certified power cord from the original manufacturer. If the product is damaged by using a non-certified power cord, it will not be repaired by our factory.
12. Be sure to unplug equipment from the power outlet before cleaning and repairing. When

not in use, do not pull the power cord to unplug the equipment. For normal power-off, please hold both ends of the plug of the equipment with your hands and pull the plug out of power outlet. This equipment needs to be connected to a grounded outlet.

13. This equipment is not waterproof, please keep it dry and do not immerse it in water or other liquids. The equipment should be installed in a dry and ventilated place, and avoid using it in rainy, humid, dusty or overheated environments. Do not place any objects on the lamp or let liquid flow into the lamp to avoid accidents.

14. Do not disassemble the product without permission. If the product fails, it must be checked and repaired by authorized maintenance personnel.

15. Before storing, make sure that the equipment has cooled down completely. For storage, unplug the power cord from the equipment. The equipment should be placed in the carrying case or in a ventilated dry place.

16. Do not place equipment near flammable and volatile solvents such as alcohol and gasoline.

17. Do not use accessories that are not recommended by our factory to avoid fire, electric shock or personal injury.

18. When cleaning, do not wipe it with a damp cloth, please use a dry cloth or a soft cloth to wipe the dirt of the equipment.

19. This product complies with ROHS CE and FCC certification, please refer to the relevant national standards for use and operation.

20. The safety instructions are formulated according to the strict testing of the factory, and the design and specifications of the equipment are subject to change without prior notice. For latest product information, please check the GODOX website and view latest electronic instruction.

21. Some products have built-in lithium batteries. Please use specified chargers, and use them within a proper range of the specified voltage and temperature according to the correct operating instructions.

22. Some products are battery powered. Do not use any batteries, power sources or accessories not specified in the instructions for such products. Keep batteries and other accessories out of the reach of children and infants. In the instance that a child or infant swallows a battery or accessory, immediate emergency medical attention is required. If the battery leaks, becomes discolored, deformed, emits smoke, or emits an abnormal odor, remove it immediately. Be careful during removal to avoid burns. Continued use could result in fire, electric shock, or burns. Do not use any deformed or modified batteries. Do not disassemble or modify this product or battery. Do not heat or solder the battery. Keep the battery away from fire or water. Do not incorrectly insert the positive and negative ends of batteries, or mix old and new batteries or batteries of different types together.

23. One-year warranty period, accessories such as consumable batteries, adapters, power cords, etc. are not covered by this warranty.
24. If it is found that the equipment is repaired without authorization, the one-year warranty period will be cancelled and relevant fees will be charged for maintenance.
25. Machine failures caused by non-standard operation are not covered by the warranty.

**Keep these instructions!**

## **Consignes de sécurité importantes et précautions**

**Tout d'abord, le principe de base : Ce produit est un équipement d'éclairage professionnel et doit être utilisé par des techniciens d'éclairage professionnels ou sous la direction de professionnels. Les consignes de sécurité de base doivent toujours être respectées lors de l'utilisation. Les consignes de sécurité spécifiques sont les suivantes :**

1. Veuillez lire et comprendre les instructions relatives au produit avant de l'utiliser.
2. Il s'agit d'un luminaire professionnel dont l'utilisation est interdite aux enfants. Les parents ou les accompagnateurs doivent surveiller étroitement les enfants lorsqu'ils sont à proximité afin qu'ils ne causent pas de blessures en se cognant au luminaire ou en l'utilisant eux même.
3. Ce luminaire n'est pas un appareil d'éclairage général et ne doit pas être utilisé pour l'éclairage général. Toute personne ayant déjà subi des dommages oculaires ou étant sensible aux yeux doit éviter d'utiliser ce luminaire.
4. Lorsque le luminaire est allumé, il doit être utilisé avec précaution et le contact avec les parties chaudes, comme les perles de la lampe LED, est interdit pour éviter les brûlures.
5. Ne regardez en aucun cas directement les perles de la lampe lorsque le luminaire est allumé. La lumière forte doit être utilisée sous la direction d'un technicien d'éclairage professionnel. Évitez en toutes circonstances une exposition prolongée à des environnements fortement éclairés. En cas de gêne oculaire, il convient d'éteindre les lumières en temps utile, de suspendre l'utilisation et de consulter rapidement un médecin.
6. Si la perle est endommagée ou déformée par la chaleur, cessez de l'utiliser et contactez le fabricant, l'agent de service ou un réparateur qualifié pour la remplacer à temps afin d'éviter les accidents.
7. Ce produit ne peut être utilisé que dans des environnements de travail où les températures sont comprises entre -20°C et 40°C et où l'humidité est normale.
8. N'utilisez pas d'équipement ou d'accessoires endommagés. N'utilisez l'équipement qu'après que le personnel d'entretien professionnel l'ait vérifié et réparé et ait confirmé qu'il est normal.

9. Si le boîtier du produit se brise en raison d'une chute, d'un écrasement ou de chocs violents en cours d'utilisation, ne continuez pas à l'utiliser afin d'éviter tout risque de choc électrique dû au contact avec les composants électroniques internes.
10. Si une rallonge est nécessaire, utiliser une rallonge dont le courant nominal est supérieur ou égal au courant nominal de l'appareil. Si la rallonge a une intensité nominale inférieure à celle de l'appareil, il peut en résulter une surchauffe.
11. Le cordon d'alimentation de certains produits est relativement long. Veuillez placer le cordon d'alimentation dans une position sûre. Évitez que le cordon d'alimentation n'entre en contact avec des surfaces surchauffées, qu'il ne soit mal placé, ce qui pourrait l'endommager ou faire trébucher le personnel du site. Veuillez utiliser notre câble d'alimentation d'origine. Tout dommage causé par l'utilisation d'un câble d'alimentation autre que celui d'origine ne sera pas couvert par notre service de réparation.
12. Avant de procéder au nettoyage et à la réparation, veillez à débrancher l'appareil de la prise de courant. Lorsqu'il n'est pas utilisé, ne tirez pas sur le cordon d'alimentation pour débrancher l'appareil de la prise de courant. Le débranchement normal doit être effectué en saisissant à la main les deux extrémités de la fiche de l'appareil et en retirant la fiche de la prise électrique. Cet appareil doit être connecté à une prise de terre.
13. Cet appareil n'est pas étanche, veuillez garder l'appareil au sec et ne pas l'immerger dans l'eau ou dans d'autres liquides. L'appareil doit être installé dans un endroit sec et ventilé, en évitant la pluie, l'humidité, la poussière ou la chaleur excessive. Pour éviter tout accident, ne placez aucun objet sur le luminaire et ne laissez pas de liquide s'écouler dans le luminaire.
14. Veuillez ne pas démonter le produit vous-même, si le produit est défectueux, il doit être contrôlé et réparé par notre société ou par un personnel de service agréé.
15. Avant de ranger cet appareil, assurez-vous qu'il se soit complètement refroidi. Débranchez le cordon d'alimentation de l'appareil lorsque vous le rangez. L'appareil doit être stocké dans le sac portatif de l'appareil ou dans un endroit ventilé et sec.
16. Ne placez pas l'appareil à proximité de solvants inflammables et volatils tels que l'alcool et l'essence.
17. N'utilisez pas d'accessoires pour des produits qui ne sont pas recommandés par l'usine car ils peuvent entraîner un incendie, un choc électrique ou des blessures corporelles.
18. Lors du nettoyage de cet appareil, n'utilisez pas de chiffon humide, mais un chiffon sec et doux pour essuyer la saleté de l'appareil.
19. Ce produit a obtenu la certification ROHS, CE et FCC. Veuillez vous référer aux normes nationales pertinentes pour l'utilisation et le fonctionnement.
20. Les consignes de sécurité sont basées sur des tests rigoureux effectués par l'usine. La conception et les spécifications de l'équipement peuvent être modifiées sans préavis.

Les clients peuvent se rendre sur le site Web de Godox pour consulter la dernière version électronique des instructions et obtenir les dernières informations sur le produit.

21. Certains produits sont alimentés par les batteries lithium intégrées. Veuillez utiliser un chargeur dédié pour la charge, suivre les instructions d'utilisation correctes et l'utiliser dans les plages de la tension et de la température spécifiées.

22. Certains produits sont alimentés par des piles. Veuillez ne pas utiliser de piles, d'alimentations ou d'accessoires non spécifiés dans les instructions de ces produits. Gardez la batterie et les autres accessoires hors de portée des enfants et des nourrissons. Si un enfant ou un nourrisson avale des piles ou des accessoires, consultez immédiatement un médecin. Si la batterie fuit, est décolorée, déformée, fume ou émet une mauvaise odeur, retirez-la immédiatement. Veuillez faire attention lors du retrait pour éviter les brûlures. Si elle est utilisée en continu, elle peut provoquer un incendie, une électrocution ou une brûlure de la peau. N'utilisez pas de batterie déformée ou modifiée. Veuillez ne pas démonter ou modifier ce produit ou la batterie. Veuillez à ne pas chauffer ou souder la batterie Ne laissez pas la batterie entrer en contact avec le feu ou l'eau. N'exposez pas la batterie à des forces extérieures importantes. N'insérez pas les bornes positives et négatives de des piles de manière incorrecte, ou mélangez des piles neuves et anciennes ou différents types de piles.

23. La durée de garantie est de 1 an. Les consommables tels que les piles, les adaptateurs, les cordons d'alimentation et autres accessoires ne sont pas couverts par cette garantie.

24. Si l'appareil est révisé sans autorisation, la période de garantie d'un an sera annulée et des frais de maintenance seront facturés.

25. La garantie ne couvre pas les pannes de la machine causées par un fonctionnement non standard.

**Conservez ces instructions.**





Do not stare at the operating light source

Veillez ne pas regarder directement la source de lumière.

AC power module USB Type-C port is only used for powering the lighting fixtures, not for powering other products.

Le port Type-C du module d'alimentation AC est uniquement destiné à alimenter la source lumineuse des luminaires, et non à alimenter d'autres produits.

## Foreword

Thank you for purchasing !

Godox is proud to introduce the new full-color LED light RS60R, which is featured with multiple color modes (CCT/HSI/RGBW/FX mode), 1800K-10000K wide CCT range, thousand-bit adjustable brightness, support wired DMX connection and Bluetooth control, high CRI light beads and etc., suitable for lighting interviews, live broadcasts, short videos, and still life shooting.

## Names of Parts

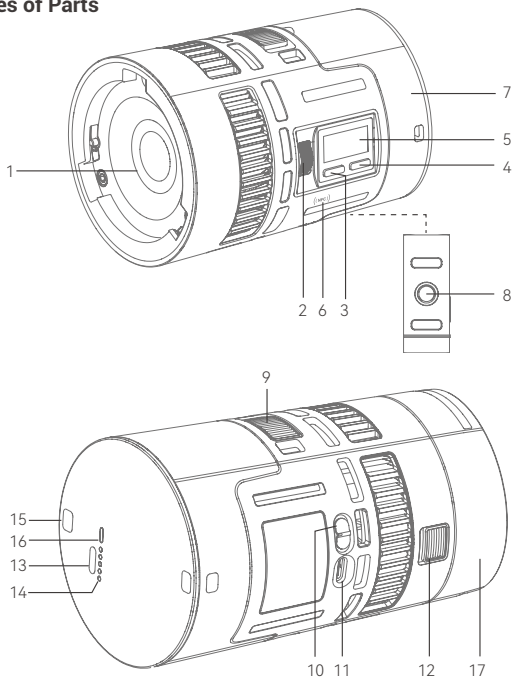

1. Light Beads
2. Select Dial (Rotate/Press)
3. MODE Button
4. MENU Button
5. Display
6. NFC Sensing Area
7. Battery
8. 1/4 " Port
9. Battery Disassemble Pusher

10. Power Switch Button
11. Light Body USB-C Port
12. Mount Locking Pusher
13. Battery USB-C Port
14. Battery Level Indicator
15. Hanging Hole \*2
16. Battery Level Indicator Button
17. Lens Reflector

## What's Inside RS60R

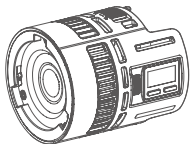

Light Body × 1

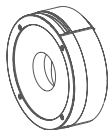

Lens Reflector × 1



Battery × 1  
(MS60BAT01)

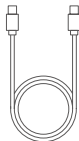

USB-C Charging Cord × 1  
(80cm)



Mount × 1  
(AD-E2)



Storage Bag × 1



Instruction Manual × 1

## What's Inside RS60R 1K

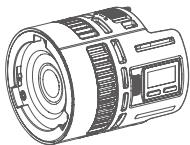

Light Body × 1

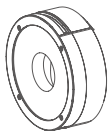

Lens Reflector × 1



Power Adapter × 1  
(MS60PA01)



Power Cord × 1



Mount × 1  
(AD-E2)

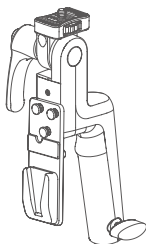

V-mount Battery Grip × 1



D-TAP Cord × 1

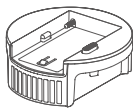

NP-F Battery Adapter Plate × 1  
(MS60NPA)

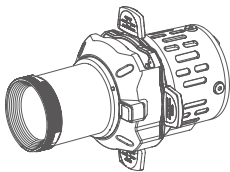

Projection × 1  
(SP36K)



Storage Bag × 1



Instruction Manual × 1

## What's Inside RS60R 2K

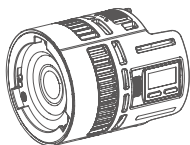

Light Body × 2

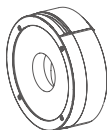

Lens Reflector × 2



Battery × 2  
(MS60BAT01)

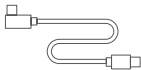

USB-C Charging Cord × 2  
(80cm)



Power Adapter × 2  
(MS60PA01)



Power Cord × 2



Mount × 2  
(AD-E2)

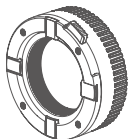

Zoom Lens × 1  
(SZL2)

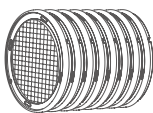
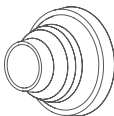
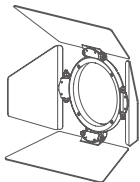

Magnet Kit × 1  
(MK)

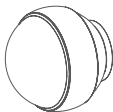

Collapsible Diffusion Dome × 1  
(SD15)

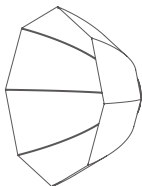

Parabolic Softbox 1' × 1'  
(SP1)



Carry Bag × 1



Instruction Manual × 1

Note: Due to continuous updates and upgrades of the products, there may be differences between the actual products and the pictures. Therefore, the pictures are for reference only, products to prevail in kind.

## Install/Disassemble the Lens Reflector

Insert the lens reflector into the light head mount and rotate the lens reflector clockwise to install it.

Aim the ▲ icon on the lens reflector at the mount locking pusher to make the lens reflector aligns with the line on the side of light body, then it can be correctly installed.

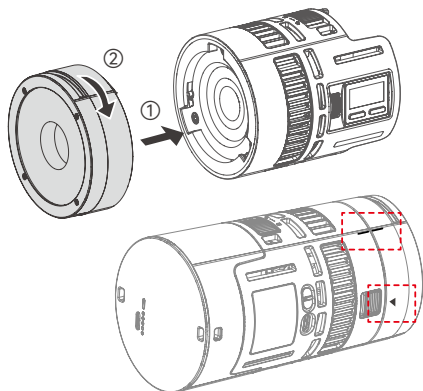

Press and hold the mount locking pusher, rotate the lens reflector anticlockwise to disassemble it.

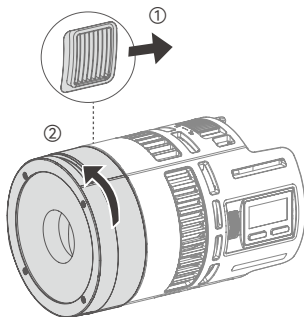

## Install/Disassemble the Mount AD-E2

Align the 1/4" port on the light body with the screw, rotate clockwise the locking device to install it, then mount on an optional tripod.

To disassemble, rotate anticlockwise the locking device to remove the light body.

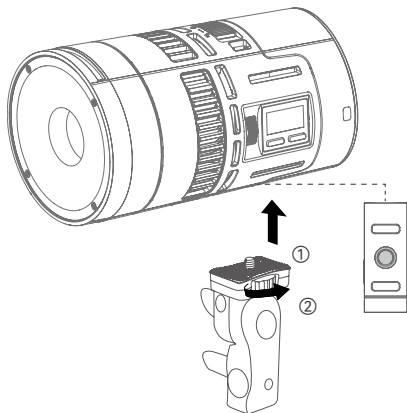

## Battery Instructions

**Installation:** Align the light body with the metal contacts at both ends of the battery, insert the battery into the slot and press it down, the battery disassemble pusher will automatically lock with a "click", and the battery is installed.

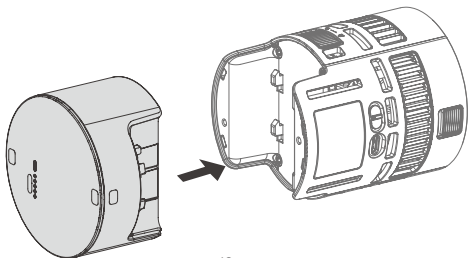



**Disassembly:** Press and hold the battery disassemble pusher, then pull the battery out to disassemble it.

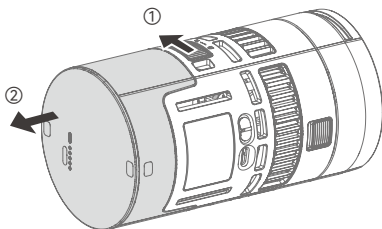

**Battery Level Indicator:** Just press down the battery level indicator button to check the battery level.

**Charging the Battery:** When the device is powered off, insert the attached USB-C charging cord into the USB-C charging port of the battery, then connect to power source to charge the battery. Please do not charge the battery in power on status.

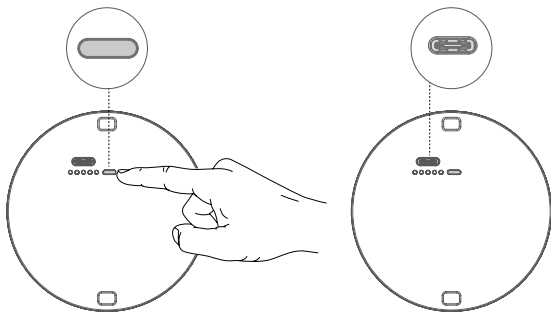

## USB-C Power Supply For the Light Body

Insert the attached USB-C charging cord into the USB-C port of the light body, then connect to power source to power the light body. Please note that the USB-C port of the light body can not charge the battery.

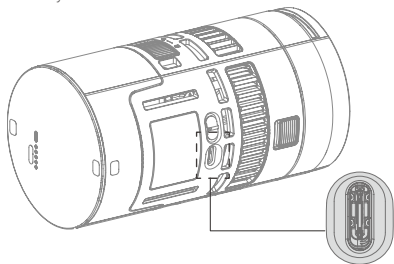

Note: An over 60W power supply device is needed.

## Wired DMX Connection

The fixture will be equipped with DMX output and input port after connecting to the DMX adapter cable DMX-C1 through USB-C port on the light body, then wired DMX connection can be achieved by connecting the controller to the fixture with DMX connecting cable.

Note: The above mentioned DMX adapter cable DMX-C1, DMX controller and DMX connecting cable are all sold separately.

## Accessories Instructions

The following accessories are either sold separately or included in different kits, so the inclusion of which depends on the actual item list of the purchased kit.



Power Cord

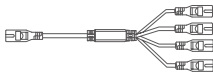

1 to 4 Power Cord

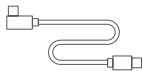

USB-C Charging Cord  
(20cm)

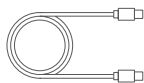

USB-C Charging Cord (80cm)



Reflector SR15

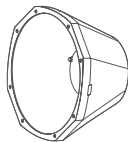

Hyper Reflector  
BeamLight S20

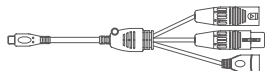

DMX Adapter Cable  
DMX-C1

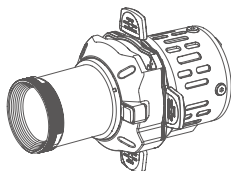

Projection SP36K

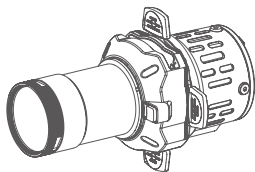

Projection SP50K

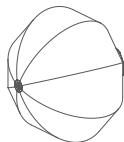

Lantern SL1

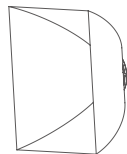

Rectangular Softbox  
SS11

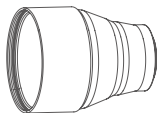

Parallel Beam Booster  
DL5 Lite

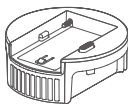

NP-F Battery Adapter  
Plate MS60NPA

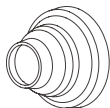

Snoot AK-SN

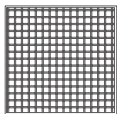

Grid SS11G

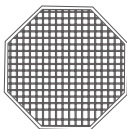

Grid SP1G

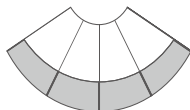

Skirt SL1S

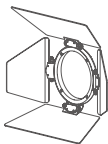

Barndoor AK-B4

## Power Adapter MS60PA01

1. Align the light body with the metal contacts at both ends of the power adapter, insert the power adapter into the slot and press it down, the battery disassemble pusher will automatically lock with a "click", and the power adapter is installed.
2. Press and hold the battery disassemble pusher, then pull the power adapter out to disassemble it.
3. Connect the power adapter to power source via the built-in 8-shaped power socket to power the light body.

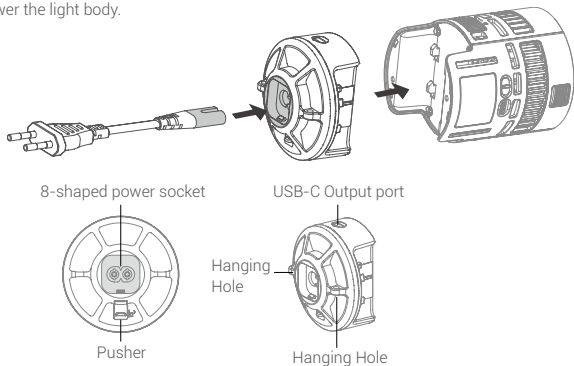

## Zoom Lens SZL2

1. Light beam with a zoom range adjustable from 15° to 30°.
2. Align SZL2 with the light head mount and insert it, rotate clockwise to install it.
3. To disassemble, press and hold the mounting locking pusher, then rotate SZL2 anticlockwise.

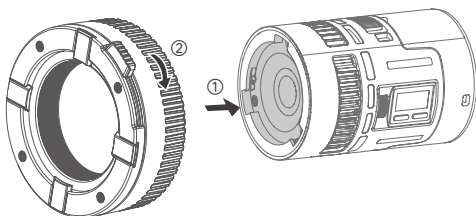

## Magnet Kit MK

1. The snoot and slides need to be collocated with the lens reflector. The snoot can also be inserted onto the locking pusher of bare light.
2. The four-way barndoor and hemispherical diffuser need to be collocated with the magnetic adapter ring.
3. Align the magnetic adapter ring with the mount on the light head, insert and rotate clockwise until the locking pusher is automatically locked, then the magnetic adapter ring is properly installed.

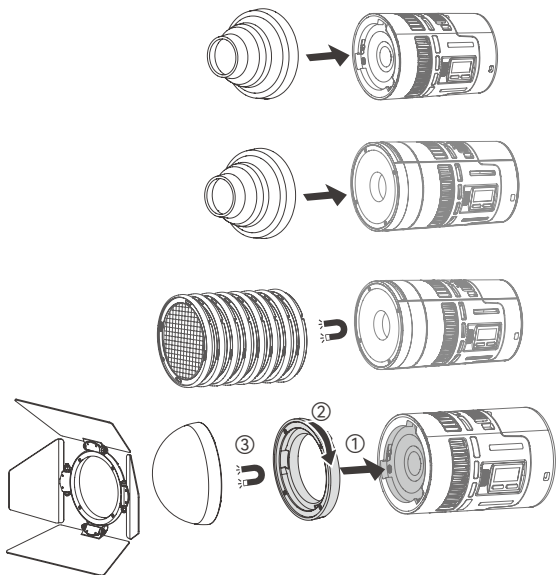

## NP-F Battery Adapter Plate MS60NPA

1. Important Note: Please make sure the load capacity of the separately purchased battery is no less than 70W, so that the fixture operates normally in high brightness mode. Or you can reduce the brightness output of the fixture to reduce the battery load and avoid triggering the automatic shutdown due to overloading.

2. Align the light body with the metal contacts at both ends of the plate, insert the plate into the slot and press it down, the battery disassemble pusher will automatically lock with a "click", and the plate is installed.

3. Press and hold the battery disassemble pusher, then pull the plate out to disassemble it.

4. The DC port on the adapter plate can be connected to 14.8V V-mount battery through optional adapter cable, which enables v-mount battery power supply.

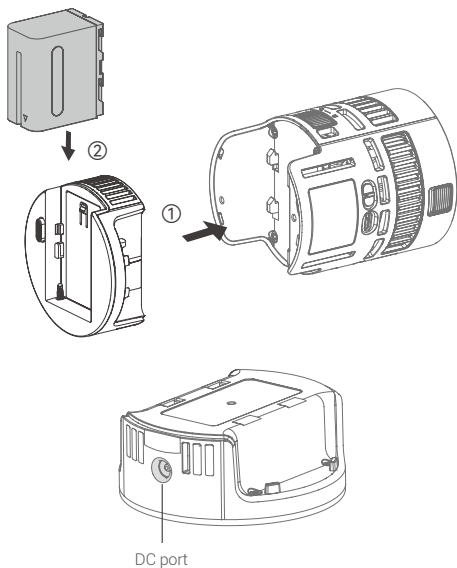

## Parabolic Softbox SP1

1. Install the parabolic softbox SP1 on the mount adapter first, the inner sides have velcros to paste on the outer white cloth and grid.
2. Align the assembled SP1 with the light head mount and insert it, rotate clockwise to complete the installation.
3. To disassemble, press and hold the mount locking pusher, and rotate SP1 anticlockwise.

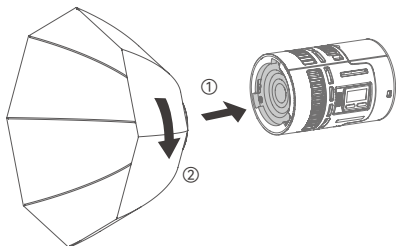

## Diffusion Dome SD15

1. Insert the flat surface of the adapter ring into the diffusion dome, then the other outside groove surface into the mount of the light head, then rotate clockwise until the locking pusher is automatically locked.
2. To disassemble, press and hold the mount locking pusher, and rotate diffusion dome anticlockwise.

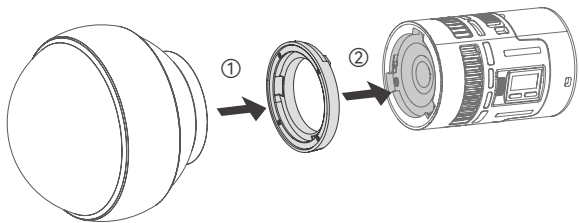

Note: Due to continuous updates and upgrades of the products, there may be differences between the actual products and the pictures. Therefore, the pictures are for reference only, products to prevail in kind.



## Power Switch

Toggle the power switch button to ON after connected to the power source can turn it on, toggle the button to OFF can turn it off. The anti-false touch function is available for setting in the menu.

## Mode Selection

Short press the MODE button to enter mode selection interface, rotate and press the select dial to choose among the following modes and adjust the corresponding parameters. Rotate the select dial upward to increase the values, while rotate downward to decrease the values.

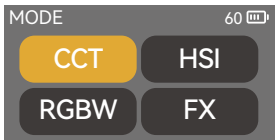

## CCT Mode

Short press the MODE button to enter CCT mode, in which you can adjust the DIM, CCT and GM.

DIM Range: 0% ~ 100%

CCT Range: 1800K ~ 10000K

GM Range: -100% ~ +100%



## HSI Mode

Short press the MODE button to enter HSI mode, in which you can adjust the DIM, HUE and SAT.

DIM Range: 0% ~ 100%

HUE Range: 0° ~ 360°

SAT Range: 0% ~ 100%

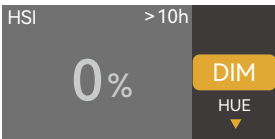

## RGBW Mode

Short press the MODE button to enter RGBW mode, in which you can adjust the DIM, R (red light), G (green light), B (blue light) and W (white light).

DIM Range: 0% ~ 100%

R Range: 0% ~ 100%

G Range: 0% ~ 100%

B Range: 0% ~ 100%

W Range: 0% ~ 100%

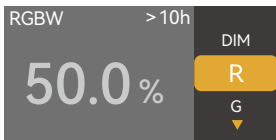

## FX Mode

Short press the MODE button to enter FX mode, in which you can choose among the following 11 effects and adjust their respective parameters. Rotate the select dial upward to increase the parameters, while rotate downward to decrease the parameters.

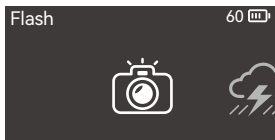

### 1. Flash

This light effect simulates the flash of a camera flash or a traditional flash bulb, often used to create a lively and dynamic atmosphere.

SW (switch): Turn on/off the effect

DIM: 0% -100% (in 0.1% increment)

Color: CCT/HSI

CCT/HUE: 1800K-10000K/0-360°

SPD (speed): 1-100

MOD (mode): Camera Flash/Flash Bulb

TRIG (trigger): Auto/Manual

### 2. Lightning

This effect simulates the natural thunder and lightning and is often used to create a tense, terrifying or mysterious atmosphere.

SW (switch): Turn on/off the effect

DIM: 0% -100% (in 0.1% increment)

CCT: 1800K-10000K

Times: Random/1-10

FREQ (frequency): Random /2-20

TRIG (trigger): Auto/Manual

### 3. Cloudy

This effect simulates the effect of cloud occlusion and is often used to create a gloomy, oppressive or sad atmosphere.

SW (switch): Turn on/off the effect

DIM: 0% -100% (in 0.1% increment)

Ratio: 30% -90%

SPD (speed): Random/1-100

### 4. Broken Bulb

This effect simulates the effect of a broken bulb and is often used to create a dim atmosphere.

SW (switch): Turn on/off the effect

DIM: 0% -100% (in 0.1% increment)

Color: CCT/HSI

CCT/HUE: 1800K-10000K/0-360°

SPD (speed): 1-100

### 5. TV

This effect simulates the effect of light from a television or screen and is often used to create a cold, mechanical or digital atmosphere.

SW (switch): Turn on/off the effect

DIM: 0% -100% (in 0.1% increment)

Color: CCT/HSI

SPD (speed): 1-100

### 6. Candle

This effect simulates the effect of light from a candle and is often used to create a soft, warm, shimmering atmosphere.

SW (switch): Turn on/off the effect

DIM: 0% -100% (in 0.1% increment)

SPD (speed): 1-100

### 7. Fire

This effect simulates the effect of light from flame and is often used to create a bright, warm, shimmering atmosphere.

SW (switch): Turn on/off the effect

DIM: 0%-100% (in 0.1% increment)

SPD (speed): 1-100

## 8. Firework

This effect simulates the effect of light from fireworks and is often used to create a gorgeous, colorful, romantic atmosphere.

SW (switch): Turn on/off the effect

DIM: 0%-100% (in 0.1% increment)

Ember: 1-100

SPD (speed): 1-100

## 9. Explosion

This effect simulates the effect of light from explosion and is often used to create a bright, fierce, shimmering atmosphere.

SW (switch): Turn on/off the effect

DIM: 0%-100% (in 0.1% increment)

Color: CCT/HSI

CCT/HUE: 1800K-10000K/0-360°

Ember: 1-100

SPD (speed): 1-100

TRIG (trigger): Auto/Manual

## 10. Welding

This effect simulates the effect of light from welding and is often used to create a hot, mechanical atmosphere.

SW (switch): Turn on/off the effect

DIM: 0%-100% (in 0.1% increment)

Color: CCT/HSI

CCT/HUE: 1800K-10000K/0-360°

SPD (speed): 1-100

## 11. Cop Car

This effect simulates the effect of light from cop car and is often used to create a tension, chasing atmosphere.

SW (switch): Turn on/off the effect

DIM: 0% -100% (in 0.1% increment)

Color: Red+Blue/Red/Blue/Blue+White/Blue+Yellow/Yellow/Red+White+Blue/Red +Yellow +Blue

MOD (mode): 1-5

## 12. SOS SOS

This effect simulates the flashing effect of an SOS signal and is often used to create a dangerous, distress or emergency atmosphere.

SW (switch): Turn on/off the effect

DIM: 0%-100% (in 0.1% increment)

Color: CCT/HSI

CCT/HUE: 1800K-10000K/0-360°

## 13. RGB Cycle

This effect simulates the effect cycle and change of colorful lights and is often used to create a fantasy, sci-fi atmosphere.

SW (switch): Turn on/off the effect

DIM: 0% -100% (in 0.1% increment)

SAT: 0%-100%

SPD (speed): 1-100

## 14. Party

This effect simulates the effect of colorful lights, flashes and laser, and is often used to create a carnival, fun, high energetic atmosphere.

SW (switch): Turn on/off the effect

DIM: 0% -100% (in 0.1% increment)

SAT: 0%-100%

SPD (speed): 1-100

Note: Please rotate the select dial to adjust the parameters, then press and rotate it to the next parameter. Select manual, the effect can be triggered once by pressing the select dial once. After a certain effect is set, press MODE button can return to the 14 effects interface.

## MENU Settings

Press the MENU button to enter menu interface, rotate and press the select dial to enter the following setting options.

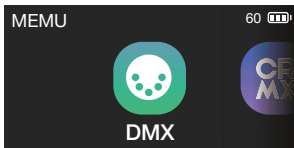

## 1. DMX

Short press the select dial to enter DMX interface, rotate and press the select dial to adjust the following settings.

DMX		60 
DMX Add		1
DMX Mode		01
RDM State		On
DMX Lost		
Termination		
Extend DMX Channels		

Level 1 Option	Level 2 Option	Description
<b>Address</b>	001-512	Initial address
<b>DMX Mode</b>	01: CCT 8Bit	CCT mode in 8bit
	02: HSI 8Bit	HSI mode in 8bit
	03: RGB 8Bit	RGB mode in 8bit
	04: RGBW 8Bit	RGBW mode in 8bit
	05: CCT+HSI 8Bit	CCT+HSI mode in 8bit
	06: CCT+RGBW 8Bit	CCT+RGBW mode in 8bit
	07: FX 8Bit	FX mode in 8bit
	08: CCT 16Bit	CCT mode in 16bit
	09: HSI 16Bit	HSI mode in 16bit
	10: RGB 16Bit	RGB mode in 16bit
	11: RGBW 16Bit	RGBW mode in 16bit
	12: FX 16Bit	FX mode in 16bit
	13: ULTIMATE 8Bit	ULTIMATE DMX mode in 8bit
	14: ULTIMATE 16Bit	ULTIMATE DMX mode in 16bit
<b>RDM State</b>	On	Turn on RDM, the controller can set the fixture address and DMX mode
	Off	Turn off RDM
<b>DMX Lost</b>	Hold Last Command	After the DMX control signal is lost, continue to use the last received DMX control signal until power down or a valid DMX control signal is received again.
	Black Out Black Out After 2 min	The light is off immediately. After the DMX control signal is lost, continue to use the last received DMX control signal for 2 minutes then black out. Note: If a valid DMX control signal is received within 2 minutes, then use the new DMX control signal.
<b>Termination</b>	On	Turn on DMX terminal
	Off	Turn off DMX terminal
<b>Extend DMX Channels</b>	On	Turn on extend DMX channels
	Off	Turn off extend DMX channels

Note: Please refer to the DMX mode specification to control the device by DMX/RDM. The electronic version can be downloaded from the official website <https://www.godox.com>.

## 2. Bluetooth

Short press the select dial to enter Bluetooth interface, rotate and press the select dial to Bluetooth to turn it on or off. If you need to reset the Bluetooth, rotate the select dial to reset and press it to choose between yes and no. The MAC code is on the left corner for quick check.

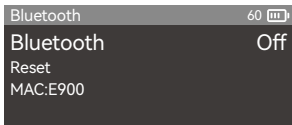

### "GODOX Light" app Downloading

Scan the QR code to download the "Godox Light" smartphone app (can be used in Android and iOS).

Note:

1. The app can be used directly on the firstly installed device (smartphone or tablet). When change to other mobile device (smartphone or tablet), the light shall be reset before the normal connection of the app.
2. The app should be version 3.0 or above.



### "GODOX Light" app Firmware Upgrade

Open Godox Light, enter a certain scene and click "+" to add a fixture, then click  to display more settings, choose firmware upgrade.

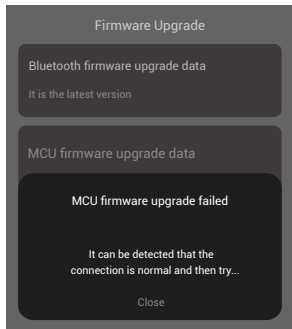

### 3. Curves

Short press the select dial to enter dimming curves interface, rotate and press the select dial to select among linear, S-curve, exponential and logarithmic.

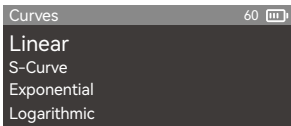

### 4. Fan

Short press the select dial to enter fan interface, rotate and press the select dial choose among off, auto, medium and high.



### 5. Anti-False Touch

Short press the select dial to enter anti-false touch interface, rotate and press the select dial choose on or off. After turning on the anti-false touch, it will not enter the main interface immediately after booting, the unlocking method will appear on the screen, rotate down the select dial to unlock and enter the main interface as shown below.

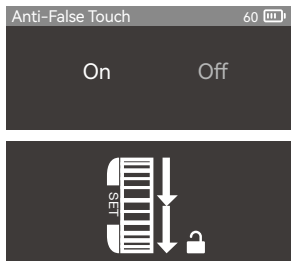



## 6. Display

Short press the select dial to enter display interface, rotate and press the select dial to adjust the display brightness from 10% to 100%.

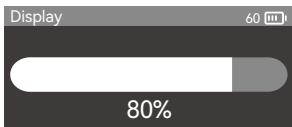

## 7. Language

Short press the select dial to enter language interface, rotate and press the select dial to choose between simplified Chinese and English.

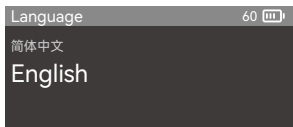

## 8. Factory Reset

Short press the select dial to enter factory reset interface to choose yes or no. If you choose yes, the device will automatically reset and reboot, then simplified Chinese and English options show on the display for your choice, after which the brightness will turn to 100% and go to CCT mode automatically.

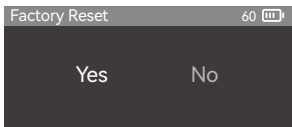

## 9. Fixture Info

Short press the select dial to enter fixture info interface to check the model, UID, firmware version, and temperature.

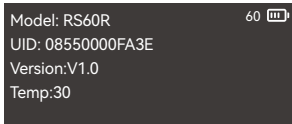

## NFC Addition

Use the NFC function of smartphone and NFC chip of the light fixture to connect them, then add the light fixture to **【Godox Light】** app.

1. Preconditions: light fixture supports NFC addition, **【Godox Light】** app is V3.2.4 or above, Bluetooth and NFC functions of smartphone are turned on.
2. Operation Instructions: subject to the fulfillment of preconditions, turn on the **【Godox Light】** app and enter the corresponding scene, click **【+】** to select **【NFC Addition】** function, bring the NFC sensing area of smartphone near the sensing area of light fixture to scan to add in **【NFC Addition】** interface, bulk addition is also supported.

Note: Android systems can complete the addition by directly closing the sensing area, while iOS system need to click the  icon on the right top and wait for the pop-up window then add.

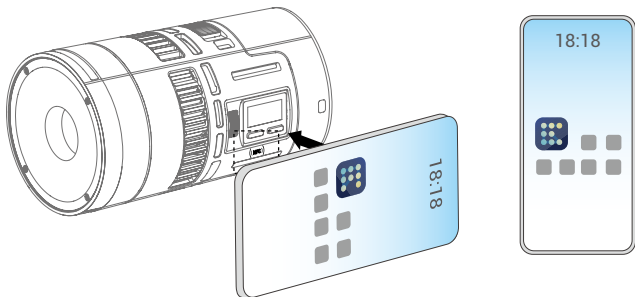

## Illuminance Data

CCT	Condition	Unit	1m	2m	3m
1800K	Bare Light	lux	≈926	≈229	≈103
		fc	≈86	≈21	≈10
2800K		lux	≈1420	≈358	≈161
		fc	≈132	≈33	≈15
3200K		lux	≈1420	≈358	≈161
		fc	≈132	≈33	≈15
4300K		lux	≈1390	≈352	≈158
		fc	≈129	≈33	≈15
5600K		lux	≈1350	≈340	≈153
		fc	≈125	≈32	≈14
6500K		lux	≈1320	≈343	≈149
		fc	≈122	≈32	≈14
8500K	lux	≈1240	≈312	≈141	
	fc	≈115	≈29	≈13	
10000K	lux	≈1210	≈304	≈137	
	fc	≈112	≈28	≈13	
R (Red)	lux	≈504	≈125	≈55	
	fc	≈47	≈12	≈5	
G (Green)	lux	≈773	≈196	≈88	
	fc	≈72	≈18	≈8	
B (Blue)	lux	≈247	≈63	≈29	
	fc	≈23	≈6	≈3	

CCT	Condition	Unit	1m	2m	3m
1800K	With Lens Reflector	lux	≈7540	≈1700	≈733
		fc	≈700	≈158	≈68
2800K		lux	≈11400	≈2740	≈1210
		fc	≈1060	≈254	≈112
3200K		lux	≈11400	≈2740	≈1220
		fc	≈1060	≈255	≈113
4300K		lux	≈11300	≈2720	≈1200
		fc	≈1050	≈252	≈112
5600K		lux	≈11000	≈2650	≈1180
		fc	≈1020	≈246	≈109
6500K		lux	≈10800	≈2600	≈1160
		fc	≈1010	≈242	≈108
8500K	lux	≈10200	≈2460	≈1090	
	fc	≈948	≈229	≈102	
10000K	lux	≈10000	≈2410	≈1070	
	fc	≈929	≈224	≈100	
R (Red)	lux	≈4200	≈964	≈408	
	fc	≈390	≈90	≈38	
G (Green)	lux	≈6480	≈1570	≈695	
	fc	≈602	≈146	≈65	
B (Blue)	lux	≈2570	≈601	≈267	
	fc	≈239	≈56	≈25	

Note: All the data are average values instead of absolute values. All the above tests are based on the condition of 100% brightness.

## Technical Data

<b>Model</b>	RS60R
<b>Lithium Battery Parameters</b>	Nominal voltage 14.4V USB-C Input: 5V= 3A, 9V= 3A, 12V= 2.5A, 20V=1.5A
<b>Light Body USB-C Port Input</b>	20V=3A Max.60W
<b>CCT</b>	1800K-10000K
<b>Brightness Range</b>	0%-100%
<b>Dimming Curves</b>	linear, S-curve, exponential, logarithmic
<b>FX Mode</b>	14
<b>CRI</b>	Average≥95
<b>TLCI</b>	Average≥95
<b>Controlling Methods</b>	Wired DMX connection, support RDM protocol/ Bluetooth app control
<b>Bluetooth Controlling Distance</b>	60m
<b>Working Environment Temperature</b>	-20°C ~ 40°C
<b>Dimension(without lens reflector and battery)</b>	≈3.03"×3.03"×3.58"
<b>Netweight(without lens reflector and battery)</b>	≈311g

Specifications and data may subject to changes without notice.

## FCC Statement

This device complies with part 15 of the FCC Rules. Operation is subject to the following two conditions:

- (1) This device may not cause harmful interference, and
- (2) this device must accept any interference received, including interference that may cause undesired operation.

Any Changes or modifications not expressly approved by the party responsible for compliance could void the user's authority to operate the equipment.

Note: This equipment has been tested and found to comply with the limits for a Class B digital device, pursuant to part 15 of the FCC Rules. These limits are designed to provide reasonable protection against harmful interference in a residential installation. This equipment generates uses and can radiate radio frequency energy and, if not installed and used in accordance with the instructions, may cause harmful interference to radio communications. However, there is no guarantee that interference will not occur in a particular installation. If this equipment does cause harmful interference to radio or television reception, which can be determined by turning the equipment off and on, the user is encouraged to try to correct the interference by one or more of the following measures:

- Reorient or relocate the receiving antenna.
- Increase the separation between the equipment and receiver.
- Connect the equipment into an outlet on a circuit different from that to which the receiver is connected.
- Consult the dealer or an experienced radio/TV technician for help.

The device has been evaluated to meet general RF exposure requirement.

The device can be used in portable exposure condition without restriction.

## IC Warning

Le présent appareil est conforme aux CNR d'Industrie Canada applicables aux appareils radio exempts de licence. L'exploitation est autorisée aux deux conditions suivantes:

- (1) l'appareil ne doit pas produire de brouillage, et
- (2) l'utilisateur de l'appareil doit accepter tout brouillage radioélectrique subi, même si le brouillage est susceptible d'en compromettre le fonctionnement

Tout changement ou modification non expressément approuvé par la partie responsable de la réglementation de l'OCDE peut faire perdre à l'utilisateur le droit d'utiliser l'appareil.

Remarque: cet appareil a été testé pour répondre aux limites des appareils numériques de classe B conformément à la partie 15 des règles de la Federal Communications Commission des États - Unis. Ces limites sont conçues pour fournir une protection raisonnable contre les interférences nuisibles dans les installations résidentielles. L'appareil génère de l'énergie RF utilisée et rayonne, ce qui peut causer des interférences nocives pour les communications radio s'il n'est pas installé et utilisé conformément aux instructions. Cependant, aucune Garantie contre les interférences dans une installation spécifique. Si l'appareil cause des interférences nuisibles à la réception de la radio ou de la télévision, qui peuvent être déterminées en éteignant et en allumant l'appareil, l'utilisateur est encouragé à tenter de corriger les interférences par une ou plusieurs des mesures suivantes:

- redirection ou repositionnement de l'antenne de réception.
- augmenter l'espacement entre l'appareil et le récepteur.
- Connecter l'appareil à une prise sur un circuit différent de celui auquel le récepteur est connecté.
- consultez votre revendeur ou un technicien radio / tv expérimenté pour obtenir de l'aide.

Avertissement RF pour les appareils portables:

L'appareil a été évalué pour répondre aux exigences générales d'exposition aux radiofréquences. Équipement Peut être utilisé sans restriction dans des conditions d'exposition portables.

## **Warning**

Operating frequency: 2402MHz – 2480MHz(BT)

Maximum EIRP Power: 7.24dBm

## **Declaration of Conformity**

GODOX Photo Equipment Co.,Ltd. hereby declares that this equipment are in compliance with the essential requirements and other relevant provisions of Directive 2014/53/EU. In accordance with Article 10(2) and Article 10(10), this product is allowed to be used in all EU member states.For more information of DoC, Please click this web link:

**<https://www.godox.com/eu-declaration-of-conformity/>**

The device complies with RF specifications when the device used at 0mm from your body.



## 产品保修

尊敬的用户，本保修卡是申请保修服务的重要凭证，请您配合销售商填写并妥善保管，谢谢！

产品信息	型号	产品条码
用户信息	姓名	联系电话
	通信地址	
销售商信息	名称	
	联系电话	
	通信地址	
	销售日期	
备注		

注：此表应由销售商盖章确认。

### 产品信息

本文件适用于相关《产品保修信息》(见后面说明)所列产品,其他非属此范围的产品或部件(如促销品、赠品及其他出厂后附加的部件等)不在此保修承诺内。

### 保修期

产品及部件的相应保修期按相关的《产品保修信息》执行。保修期自产品首次购买日起算,购买日以购买产品时保修卡登记日期为准。

### 如何获得保修服务

您可直接与产品销售商或授权服务机构联系,也可拨打神牛产品售后服务电话,与我们联系,由我们的服务人员为您安排服务。申请保修时,您应提供有效的保修卡作为保修凭证,方可获得保修。如您不能提供有效的保修卡,则在我们确认产品或部件属于保修范围的情况下,也可以为您提供保修,但这不作为我们的义务。

## 不适用保修情况

如产品存在下列情况，本文件项下的保证和服务将不适用：①产品或部件超过相应保修期；②错误或不适当使用、维护或保管导致的故障或损坏，如：不当搬运；非按产品合理预期用途使用；不当插拔外接设备；跌落或外力挤压；接触或暴露于不适当温度、溶剂、酸碱、水浸或潮湿环境；③由非神牛授权机构或人员安装、修理、更改、添加或拆卸造成的故障或损坏；④产品或部件原有识别信息被修改变更或删除；⑤无有效保修卡；⑥使用非合法授权、非标准或非公开发行的软件造成的故障或损坏；⑦因不可抗力或意外事件造成的故障或损坏；⑧其他非因产品本身质量问题导致的故障或损坏。遇上述情况，您应向相关责任方寻求解决，神牛对此不承担任何责任。因非在保修期或保修范围内的部件、附件或软件导致产品不能正常使用的，不是保修范围内的故障。产品使用过程中正常的脱色，磨损和消耗，不是保修范围内的故障。

## 产品保修和服务支持信息

产品的保修期和服务类型按以下《产品保修信息》执行：

产品类别	选件名称	保修期(月)	保修服务类型
部件	电路板	12	客户送修
	电池	3	客户送修
	充电器等带电性能的部件。	12	客户送修
其他	如外壳、保护罩、锁紧装置、包装等。	无	无保修

神牛产品售后服务电话 0755-29609320-8062

## Warranty

Dear customers, as this warranty card is an important certificate to apply for our maintenance service, please fill in the following form in coordination with the seller and safe-keep it. Thank you!

Product Information	Model	Product Code Number
Customer Information	Name	Contact Number
	Address	
Seller Information	Name	
	Contact Number	
	Address	
	Date of Sale	
Note		

Note: This form shall be sealed by the seller.

### Applicable Products

Applicable Products The document applies to the products listed on the Product Maintenance Information (see below for further information). Other products or accessories (e.g. promotional items,giveaways and additional accessories attached,etc.) are not included in this warranty scope.

### Warranty Period

The warranty period of products and accessories is implemented according to the relevant Product Maintenance Information. The warranty period is calculated from the day(purchase date) when the product is bought for the first time,And the purchase date is considered as the date registered on the warranty card when buying the product.

### How to Get the Maintenance Service

If maintenance service is needed, you can directly contact the product distributor or authorized service institutions. You can also contact the Godox after-sale service call and we will offer you service. When applying for maintenance service, you should provide valid warranty card. If you cannot provide valid warranty card, we may offer you maintenance service once confirmed that the product or accessory is involved in the maintenance scope, but that shall not be considered as our obligation.

## Inapplicable Cases

The guarantee and service offered by this document are not applicable in the following cases: ① **The product or accessory has expired its warranty period;** ② **Breakage or damage caused by inappropriate usage, maintenance or preservation, such as improper packing, improper usage, improper plugging in/out external equipment, falling off or squeezing by external force, contacting or exposing to the improper temperature, solvent, acid, base, flooding and damp environments, etc;** ③ **Breakage or damage caused by non-authorized institution or staff in the process of installation, maintenance, alternation, addition and detachment;** ④ **The original identifying information of product or accessory is modified, alternated, or removed;** ⑤ **No valid warranty card;** ⑥ **Breakage or damage caused by using illegally authorized, nonstandard or non-public released software;** ⑦ **Breakage or damage caused by force majeure or accident;** ⑧ **Breakage or damage that could not be attributed to the product itself.** Once met these situations above, you should seek solutions from the related responsible parties and Godox assumes no responsibility. The damage caused by parts, accessories and software that beyond the warranty period or scope is not included in our maintenance scope. The normal discoloration, abrasion and consumption are not the breakage within the maintenance scope.

## Maintenance and Service Support Information

The warranty period and service types of products are implemented according to the following Product Maintenance Information:

Product Type	Name	Maintenance Period(month)	Warranty Service Type
Parts	Circuit board	12	Customer sends the product to designated site
	Battery	3	Customer sends the product to designated site
	Electrical parts e.g.battery charger, etc.	3	Customer sends the product to designated site
Other Items	Lamp body, lamp cover, locking device, package, etc.	No	Without warranty

合格证

QC PASS



Wechat  
Official Account  
神牛微信公众号

### 深圳市神牛摄影器材有限公司

地址：深圳市宝安区福海街道塘尾社区耀川工业园厂房2栋

电话：0755-29609320 (8062) 传真：0755-25723423 邮箱：godox@godox.com

### GODOX Photo Equipment Co., Ltd.

Add.: Building 2, Yaochuan Industrial Zone, Tangwei Community, Fuhai Street, Bao'an District, Shenzhen

518103, China Tel: +86-755-29609320(8062) Fax: +86-755-25723423 E-mail: godox@godox.com

[www.godox.com](http://www.godox.com)

Made in China | 705-RS60R0-03

UK  
CA

CE

FC

