



Wechat
Official Account
神牛微信公众号

深圳市神牛摄影器材有限公司

地址：深圳市宝安区福海街道塘尾社区耀川工业园厂房 2 栋
电话：0755-29609320 (8062) 传真：0755-25723423 邮箱：godox@godox.com

GODOX Photo Equipment Co., Ltd.

Addr.: Building 2, Yaochuan Industrial Zone, Tangwei Community, Fuhai Street, Bao'an District, Shenzhen
518103, China Tel: +86-755-29609320(8062) Fax: +86-755-25723423 E-mail: godox@godox.com

www.godox.com

Made in China | 705-AD10P2-01



Godox

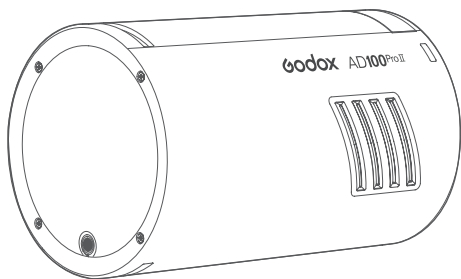

AD100Pro II

口袋灯
Pocket Flash

使用手册
Instruction Manual

目录

重要安全提示	2
前言	4
产品特性	4
部件名称	5
物品清单	7
电池的使用	8
开关机与自动关机 / 休眠	10
闪光模式	11
TTL 自动闪光	11
M 手动闪光	12
Multi 频闪闪光	13
高速同步	14
造型灯	14
2.4G 无线传输	15
无线设置	15
连接方法 (以 X3 引闪器为例)	16
操作范围	16
无线多重闪光拍摄	16
漏闪原因及解决办法	17
神牛 FT433 功能使用	18
自定义功能	19
其他功能	20
保护功能	21
规格参数	23
固件升级	24
维护保养	24

重要安全提示

本产品属于专业摄影设备，需要专业人员操作使用。使用前必须拆除产品上的所有运输保护材料和包装。使用时必须遵守以下基本安全预防措施：

1. 使用本产品前，请仔细阅读并完全理解产品说明书，严格按照说明书中的安全提示操作。否则，可能导致死亡、严重伤害、产品损坏或其他财产损失的安全隐患。
2. 闪光灯工作时存在高电压，关机后设备内部电容将持续带电一段时间。
3. 本产品为专业灯具，儿童禁止使用。儿童接近时，成人必须密切监督，防止儿童碰撞灯具或私自使用灯具，造成人身伤害。
4. 本灯具并非普通灯具，不可用于普通照明，任何有过眼部损伤或眼部敏感的人群均应避免使用本灯具或直视本灯具。
5. 使用时必须小心，严禁接触如闪光管等高温部件，以避免烫伤。
6. 任何情况下均禁止将闪光灯直接对准人眼（特别是婴儿眼睛），否则短时间内可能导致视力损伤。如感到眼睛不适，应立即关闭灯具，停止使用并及时就医。
7. 闪光灯损坏时，应立即停止使用，及时联系制造商、服务代理商或合格维修人员更换，以防发生事故。
8. 严禁使用损坏的设备或配件，必须等待专业维修人员检查维修并确认设备正常后，才可继续使用。
9. 更换灯管、保护玻璃或保险丝前，必须断开电源或者拆下电池（如装有电池），确保灯具与电源完全断开。更换灯管前让其冷却 10 分钟，操作时需戴绝缘 / 或隔热手套。
10. 拔插头灯头插头时必须关闭产品电源，插入插头时务必检查是否完全卡入。
11. 使用过程中，如果产品因跌落、挤压或强力冲击导致外壳破裂，应立即停止使用，避免接触内部电子部件而触电受伤。
12. 如果需要使用延长线，请使用原装延长线或选择额定电流大于等于设备的延长线。使用额定电流过小的延长线可能会过热起火。
13. 部分产品电源线较长，请合理放置，避免接触热源或绊倒他人。建议使用原装电源线。非原装线造成的损坏不在保修范围内。
14. 进行清洁和维修前，请先从电源插座上拔出设备电源插头。不要拉扯电源线强行拔出，正确方法是用双手抓住插头端拔出。
15. 本设备不防水，请保持干燥，不能浸入水或其他液体，应安装在通风干燥位置，避免在雨天、潮湿、多尘或过热环境中使用。不要在设备上方放置物品，或让液体流入内部，防止发生危险。
16. 未经授权，请不要自行拆卸本产品。产品若出现故障，必须由本公司或授权维修人员检查和维修。
17. 存放设备前，请确保设备已完全冷却，拔下电源线，放入设备包内或通风干燥位置。
18. 请勿将设备放置在酒精、汽油等易燃挥发性溶剂或气体如甲烷、乙烷等附近。
19. 本设备禁止在有爆炸危险的环境中使用或存放。
20. 严禁覆盖设备散热口！

21. 请勿使用未经本公司认可的配件, 以免造成火灾、触电或人身伤害。
22. 清洁设备时, 请用干燥软布轻轻擦拭, 不可使用湿布, 否则可能会损坏设备。
23. 部分产品配备保护罩, 使用前必须取下。
24. 本使用说明基于严格测试制定, 设计和规格变更恕不另行通知。您可登录我们官方网站查看最新电子版使用说明, 了解产品最新资讯。
25. 部分产品内置锂电池, 必须使用专用充电器充电, 并按正确操作说明, 在规定电压和温度范围内使用。
26. 部分产品使用锂电池供电。这类锂离子电池使用寿命有限, 会逐渐失去储电能力, 这种能力下降不可逆。电池老化时, 产品续航时间会减少。锂离子电池使用寿命预计 2—3 年。请定期检查电池情况, 如果充电时间明显增加或续航时间明显减少, 请考虑更换新电池。
27. 部分产品配备锂电池, 其储存建议如下: 储存前, 将电池充放电至约 50% 电量; 至少每 6 个月充电一次, 至约 50% 电量; 可拆卸电池应单独存放; 储存温度在 0°C 至 40°C 范围内。
28. 部分产品使用锂电池供电, 请注意以下事项:
 - 不要拆卸、压碎或刺穿电池;
 - 避免使电池触点短路;
 - 不要在火中或水中处理电池;
 - 不要将电池暴露在 60°C 以上高温下;
 - 将电池放在儿童接触不到的位置;
 - 防止电池遭受过度冲击或振动;
 - 不要使用已损坏的电池;
 - 如果电池出现泄漏, 请避免接触泄漏液体;
 - 如果眼睛接触电池液体, 立即用水冲洗至少 15 分钟, 抬起眼睑直到没有液体的迹象后及时就医。
29. 处理任何电池前, 请确认并遵守当地相关法律法规。
30. 本设备整机的保修期为一年。消耗品如电池、适配器、电源线等配件不在保修范围内。
31. 私自维修将取消保修资格, 需支付维修费用。
32. 请收到锂电池时及时检查电池状态、电量情况, 如有任何质量问题及时在保修期内联系神牛或神牛所授权的经销商。
33. 不当操作导致故障不在保修范围。
34. 消费者若使用电源适配器充电, 则应购买配套使用获得 CCC 认证并满足标准要求的电源适配器。
35. 电池禁止拆解、撞击、挤压或投入火中。若出现严重鼓胀, 请勿继续使用。请勿置于高温环境中。浸水后禁止使用。
36. 使用时, 应放置在易散热的地方, 不要放置在床头、被褥上、包裹里或其他不易散热的环境中使用, 避免婴幼儿接触玩耍, 儿童请在成人指导下使用。

前言

感谢您选择神牛 AD100PROII 口袋灯。这是一款专业级的闪光灯，集 100Ws 强劲功率与小巧便携的机身于一体。它内置神牛 2.4G 无线 X 系统，可作为无线多灯系统中的从属单元，全面兼容佳能、尼康、索尼、富士、奥林巴斯、松下、宾得等主流相机品牌的 TTL 自动闪光功能，是商业摄影师、新闻记者和摄影爱好者的理想光源。

产品特性

- **全面兼容的无线 TTL 系统**：内置神牛 2.4GHz 和 433MHz 双无线系统，支持主流品牌相机的 TTL/M/Multi 模式，拍摄简单快捷。
- **强大功率与极致便携**：拥有 100Ws 的大功率，体积小巧。机身新增防滑纹理，握持手感更稳固。
- **升级的操作体验**：配备彩色高清显示屏，并优化了按键布局与交互逻辑，使操作更直观高效。
- **专业的供电方案**：高性能锂电池确保快速回电。电池新增 USB-C 充电接口，可直接为电池充电，极大提升了灵活性和便利性。
- **精准的调光与高速性能**：功率调节范围从 1/256 至 1/1 全功率，支持 0.1 档精细微调。最高支持 1/8000 秒高速同步，满足各类创意拍摄需求。
- **直观的组别识别**：机身新增了物理的组别识别灯，在多灯环境下可以快速辨认灯光所属的组别。

部件名称

机身

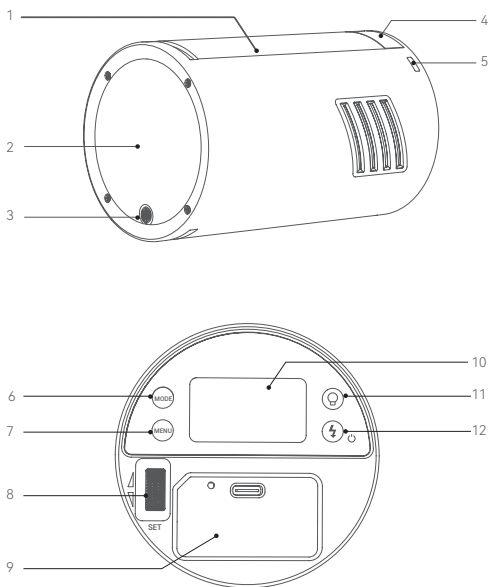

1. 机身 (带防滑纹理)

2. 光学镜片

3. LED 造型灯

4. 光控接收器

5. 组别识别灯

6. MODE 按键

7. MENU 按键

8. SET 拨轮

9. 电池 (带 USB-C 充电口)

10. 彩色显示屏

11. 造型灯 按键

12. 试闪 / 电源 按键

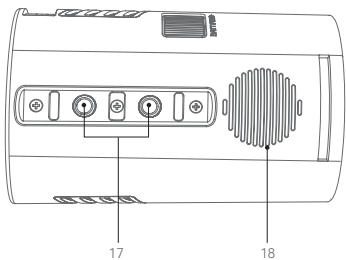
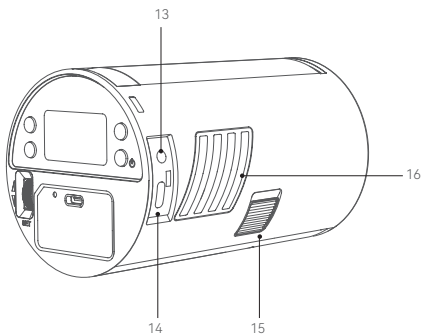

13. 3.5mm 同步插孔

14. USB-C 固件升级 /FT433 接口

15. 电池装卸推制

16. 风扇进风口

17. 1/4" 标准安装孔

18. 风扇出风口

物品清单

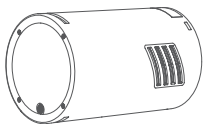

灯体 × 1



电池 × 1



充电头 × 1



便携包 × 1



USB 充电线 × 1



支架 AD-E2 × 1



说明书 × 1

可另购附件

可搭配神牛丰富的附件系统，以获得最佳拍摄效果和体验：

- **引闪器**：XPro 系列、X2T 系列、X3 系列引闪器
- **光效附件**：AK-R1 圆形灯头附件套装、S2 支架（可转接保荣卡口附件）
- **通用附件**：柔光箱、雷达罩、柔光伞、束光筒、灯架等

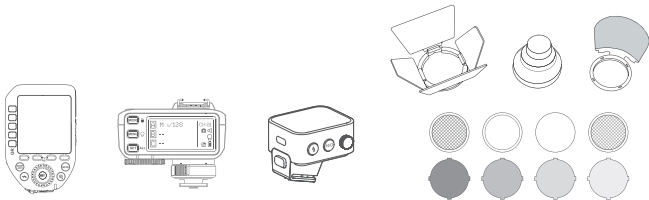

电池的使用

电池特性

1. 采用高品质锂电池，满电状态下支持约 490 次全功率输出。回电时间约为 0.01-1.5 秒。
2. 内置电路有过充、过放、过流和短路保护，安全可靠。
3. 使用标配电池充电器，从低电量到满电的充电时长约 2 小时 45 分钟

注意事项

1. 避免正负极短路。
2. 电池没有防水功能，不要把电池浸泡在雾、水中。
3. 放置于儿童不易接触的地方。
4. 电池充电不要放置超过 8 小时。
5. 电池应放置于凉爽、干燥及通风的地方存储。
6. 电池不要靠近和放置于火中。
7. 电池使用报废后请按当地的规定处理。
8. 长期不使用，请充电至 60% 再放置。
9. 建议每 3 个月对电池进行一次充电保养。

充电方法

将电池从机身取下，使用标配的充电器和 USB-C 线进行充电。

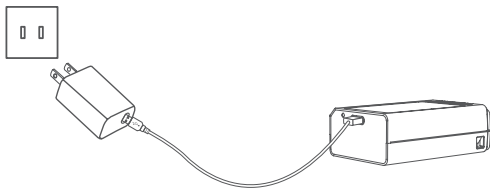

- 通过屏幕上电池电量显示查看剩余电量。

(注：电池图标变红表示低电量，请及时充电。)



装卸电池

安装：将电池对准机身内电池槽推入，听到“咔”的声音，且装卸推制复位即表示安装到位。

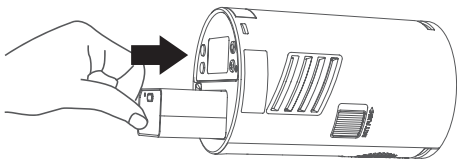

拆卸：向上拨动电池装卸推制，电池将自动弹出。请用手接住以防跌落。

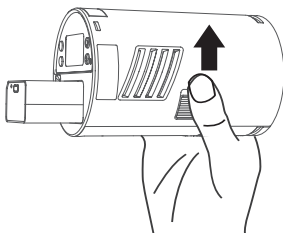

开关机与自动关机 / 休眠

- **开关机：**长按 [电源 / 试闪] 键可开机或关机。（注：开机后屏幕显示：向下滑动滑轮解锁，如开机后 6 秒无操作后将自动关机。）
- **自动关机 / 休眠：**为节省电量，本产品设有自动关机 / 休眠功能。可在菜单中设置无人操作后进入休眠或自动关机的时间（可选 30/60/90/120 分钟）。在离机使用时，建议关闭此功能。



闪光模式

短按 [MODE] 键，可依次在 M (手动) -> Multi (频闪) -> TTL (自动) 模式间切换。

• TTL 自动闪光

使用此模式，闪光灯会通过相机测光系统自动调节输出量，使主体和背景获得均衡曝光。您可以通过无线引闪器对闪光曝光补偿 (FEC) 进行调整。

注：只有开启无线功能，才能支持 TTL 模式。



TTL 模式设置：

1. 短按 [MENU] 键进入菜单栏，转动 [SET 拨轮] 选中“无线”项，短按 [SET 拨轮] 进入设置界面，开启无线功能，并将组别、频道和识别号的设置与主控单元保持一致，设置完毕短按 [MENU] 键回到主界面；
2. 短按 [MODE] 键，将闪光模式切换至 TTL 模式即可。

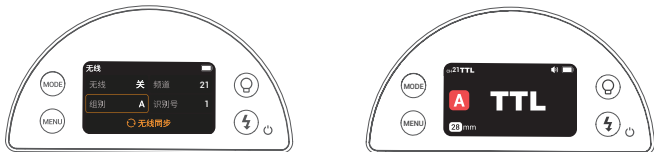

焦距调节：在此模式下，短按 [SET 拨轮] 进入焦距设置界面，转动 [SET 拨轮] 调节焦距。

• M 手动闪光

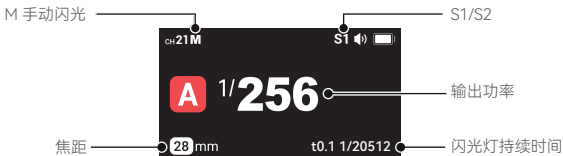

功率调节：在此模式下，转动 [SET 拨轮]，以 0.1 为一档，在 1/256 至 1/1 之间设置闪光输出功率。

焦距调节：在此模式下，短按 [SET 拨轮] 进入焦距设置界面，转动 [SET 拨轮] 可在 28 至 85mm 之间调节焦距。

闪光灯持续时间

闪光灯持续时间是指闪光灯从开始发光到达发光半峰值的时间长度。半峰值的表示为 $t=0.5$ 。为了给摄影师提供更详细的拍摄数值，本产品采用 $t=0.1$ 。 $t=0.5$ 与 $t=0.1$ 的区别如下图：

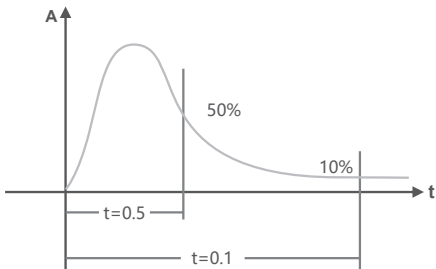

注：只有在 M 模式并关闭高速同步时，才会显示闪光持续时间。

光控引闪 (S1/S2)

短按 [MENU] 键进入菜单栏, 转动 [SET 拨轮] 选中“光控引闪”项, 短按 [SET 拨轮] 进入设置界面, 转动 [SET 拨轮] 可在 关闭 /S1/S2 三个选项中进行选择。

S1 模式: 闪光灯可作为副灯使用, 创造多种照明效果, 适用于手动闪光环境。它会与主闪光灯的第一次闪光同步触发闪光, 效果与使用无线引闪器一致。

S2 模式 (防预闪): 闪光灯可作为副灯使用, 适用于 TTL 闪光环境; 具有防预闪功能, 使用带一次预闪功能的相机能用光控实现同步拍摄。它会忽略主灯发出的 TTL 预闪, 与第二次的主闪同步触发, 即 2 次光控引闪。

注: 只有在 M 模式下才支持 S1/S2 光控引闪模式。

• Multi 频闪闪光

使用此模式, 可以发出一系列快速闪光, 实现在一张照片上拍摄移动物体的多个图像。

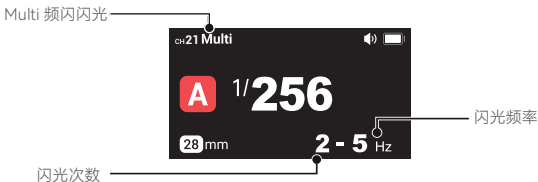

功率调节: 在此模式下, 转动 [SET 拨轮] 可在 1/256 至 1/4 之间调节闪光输出功率。

焦距、闪光次数和闪光频率调节:

在此模式下, 短按 [SET 拨轮] 进入焦距设置界面, 转动 [SET 拨轮] 调节焦距; 再次短按 [SET 拨轮] 进入闪光次数设置界面, 转动 [SET 拨轮] 调节闪光次数; 再次短按 [SET 拨轮] 进入闪光频率设置界面, 转动 [SET 拨轮] 调节闪光频率。

计算快门速度

在频闪闪光过程中, 到闪光停止为止快门应保持开启状态。使用下面的公式计算快门速度, 然后用相机进行设置:

闪光次数 / 闪光频率 = 快门速度

例如, 如果闪光次数是 10, 闪光频率是 5Hz, 快门速度则至少为 2 秒。

- 注：1. 反光很强的被摄体在暗背景前使用频闪闪光更加有效。
2. 推荐使用三脚架和 TTL 引闪器。
3. 闪光输出为 1/1 和 1/2 时不能设置频闪闪光。



高速同步

使用高速同步（FP 闪光），您可以在所有的快门速度下同步使用闪光灯。高速同步模式下，使用光圈优先对人像进行填充闪光时特别方便。

1. 短按 [MENU] 键进入菜单栏。
2. 转动 [SET 拨轮] 选中“高速同步”项，短按 [SET 拨轮] 进入设置界面，转动 [SET 拨轮] 选择“开”，回到主界面后，上方状态栏会显示  图标。

请使用 XPro、XProll、X2T、X3 系列引闪器

注：

- 如果设置快门速度等于或慢于相机的最大闪光同步速度，取景器中将不显示 <  > 图标。
- 使用高速同步，快门速度越高，有效的闪光范围就越小。
- 要恢复普通闪光，请进入菜单栏将高速同步功能关闭，主界面中 <  > 图标会消失。
- 在高速同步模式下，无法设置频闪闪光。
- 连续高速同步闪光 60 次后，闪光灯热保护功能可能会被激活。

造型灯

打开造型灯与亮度调节：短按 [造型灯] 键，根据屏幕提示，按压 [SET 拨轮] 打开造型灯，随后进入亮度调节界面，转动 [SET 拨轮] 可调节造型灯亮度。

关闭造型灯：短按 [造型灯] 键，回到造型灯亮度调节界面，再按一次 [SET 拨轮] 即可关闭造型灯。

（注：长按 [造型灯] 键可以打开或关闭造型灯。）

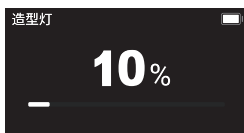

模式调节: 短按 [MENU] 键进入菜单栏, 转动 [SET 拨轮] 选中“造型灯”项, 短按 [SET 拨轮] 进入设置界面, 转动 [SET 拨轮] 选择 持续 / 闪灭 模式。



2.4G 无线传输

AD100ProII 使用 2.4G 无线 X 系统, 可以与本厂其他型号完美结合使用。作为从属单元可兼容的相机有佳能、尼康、索尼、奥林巴斯、松下、富士、宾得、莱卡等, 根据主控单元自动切换, 无需手动设置。

AD100PROII 作为从属单元, 可由神牛 X 系列引闪器 (如 XProII, X3, X2T 等) 或神牛带主控功能的机顶灯 (如 V1Pro 系列 /V100 系列 /V860III 系列) 控制。

无线设置

短按 [MENU] 键进入菜单栏, 转动 [SET 拨轮] 选中“无线”项, 短按 [SET 拨轮] 进入设置界面。



参数设置: 短按并转动 [SET 拨轮], 可依次设置以下参数。

无线	开 / 关
频道	1-32
组别	0-9、A-F
识别号	关闭、1-99
无线同步	约 100 米无线传输距离

注: 如果在拍摄现场不止一个无线闪光系统, 您可以通过更改通讯频道或设置识别号来防止信号干扰, 保证主控单元和从属单元设置为相同的频道编号即可。

连接方法（以 X3 引闪器为例）

1. 在 AD100PROII 上开启无线功能，并设置好频道，组别和识别号；
2. 在 X3 引闪器上找到“无线”选项，将频道和识别号设置为与 AD100PROII 相同的值，两端分别点击“无线同步”，AD100PROII 上显示“同步成功”即完成连接；
3. 返回 X3 主界面，找到与 AD100PROII 对应的组别，可设置该组的模式和功率等参数；
4. 按下相机快门即可完成无线引闪拍摄。

操作范围

- 使用一个从属单元进行自动闪光拍摄

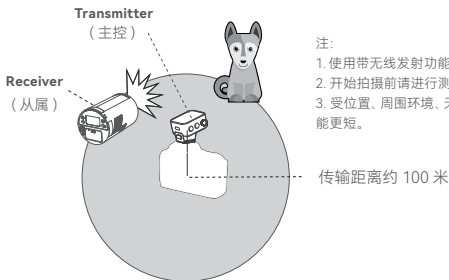

注：

1. 使用带无线发射功能的主控单元作为发射端。
2. 开始拍摄前请进行测试闪光和试拍。
3. 受位置、周围环境、天气状况等影响，传输距离可能更短。

无线多重闪光拍摄

可以将从属单元分割为两个或三个组，并在改变闪光光比（倍率）的同时进行 TTL 自动闪光拍摄。此外，可以为各闪光组设定不同的闪光模式进行拍摄。

- 用两个从属组进行自动闪光拍摄。
- 用三个从属组进行自动闪光拍摄。

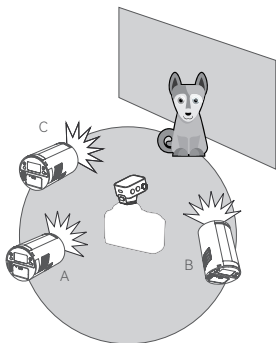
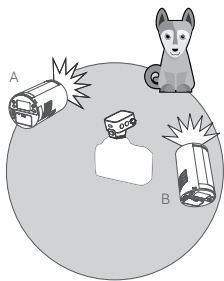

漏闪原因及解决办法

1. 外部环境干扰 (如无线基站、2.4G WiFi 路由、蓝牙设备等)

→解决办法: 请调节引闪器的频道 CH 设置 (建议 +10), 找到无干扰的频道, 并在工作时关闭其他 2.4G 设备。

2. 请确认闪光灯是否已经回电或回电速度是否跟上连拍速度 (闪光灯就绪指示灯已经亮起), 并且没有处于过热保护或者其他异常状态中。

→解决办法: 请下调闪光灯档位, 如是 TTL 模式可以尝试改为 M 模式 (TTL 模式下需要预闪一次)。

3. 引闪器和闪光灯距离太近 (<0.5m)

→解决办法: 请在引闪器上打开“近距离无线模式”:
 X1 系列: 按住引闪按钮不放, 开机后指示灯闪 2 次。
 Xpro、X2T 系列: 设置 C.Fn-DIST 为 0-30m。
 X3 系列: 设置引闪距离为 0-30m。

4. 引闪器和接收端设备电量低

→解决办法: 请更换电池或及时充电。

神牛 FT433 功能使用

为创造更高的信号稳定性和抗干扰能力，实现闪光灯精准控制，推荐搭配使用神牛 FT433 引闪器。FT433 引闪器由【发射器 FT433】和【接收器 FR433】两部分组合使用，内置 433MHz 无线模块，做到传输距离更长的同时极大地提高抗干扰能力，为您提供稳定精准的拍摄体验。FT433 引闪器兼容佳能、尼康和索尼热靴相机，适用于 AD100Pro II、AD200Pro II、AD400Pro II、AD600Pro II、AD600BM II 等 Godox 神牛全新升级的二代闪光灯。

使用方法：



1. 关闭引闪器、相机、闪光灯的电源，将发射器 FT433 安装在相机热靴插座，接收器 FR433 插入 AD100Pro II 机身上的 USB-C 固件升级接口，并将发射器和接收器顶部的天线旋转出来，然后将引闪器、相机以及闪光灯的电源都打开。
2. 设置 FT433：短按 [MENU] 键进入菜单栏，选中 [(P)] 后短按 [SET] 键设置频道、识别号，设置完成短按 [MENU] 键回到主界面。短按 [MODE·LOCK] 键设置引闪器模式，旋转拨盘设置引闪器档位参数。
3. 设置 AD100Pro II：短按 [MENU] 键进入菜单栏，转动 [SET 拨轮] 选中“无线”项，短按 [SET 拨轮] 进入设置界面，设置同引闪器一致的频道、组别、识别号。
4. 按下相机快门即可引闪，引闪器状态指示灯会闪亮红色。

注：FT433 引闪器需另购。

自定义功能

短按 [MENU] 键进入菜单栏，通过转动 [SET 拨轮] 选中菜单中的某一项，短按 [SET 拨轮] 并转动拨轮进行该项设置，设置完毕短按 [MENU] 键返回。

图标	功能	选项	说明
	无线	关	关闭无线设置
		开	设置通讯参数
	光控引闪	关	关闭光控引闪
		S1	M 模式下支持开启
		S2	
	高速同步	关	关闭高速同步
		开	M 模式下支持开启
	造型灯	闪灭	闪光灯回电灭
		持续	常亮
	蜂鸣器	关	蜂鸣器关闭
		开	蜂鸣器开启
	功率显示	1/256	1/1 至 1/256 范围内可调
		2.0	3.0 至 10.0 范围内可调
	屏幕待机	30 秒	超过 30 秒无人操作，屏幕进入休眠
		1 分钟	超过 1 分钟无人操作，屏幕进入休眠
		2 分钟	超过 2 分钟无人操作，屏幕进入休眠
		3 分钟	超过 3 分钟无人操作，屏幕进入休眠
	自动关机	关	关闭自动关机
		30 分钟	30 分钟后自动关机
		60 分钟	60 分钟后自动关机
		90 分钟	90 分钟后自动关机
		120 分钟	120 分钟后自动关机
	屏幕亮度	20%-100%	旋转拨盘设置亮度值
	延时闪光	关	关闭延时闪光
		0.01-30.0 秒钟	设置延时时长

	语言	中文	界面中字体显示简体中文
		English	界面中字体显示 English
	恢复出厂设置	是	恢复出厂设置
		否	取消恢复出厂设置
	设备信息	无选项	查看当前机器型号及版本号

其他应用

同步插孔触发

同步插孔规格为 $\Phi 3.5\text{mm}$ ，此处可插入同步线或者触发器触发插头对闪光灯进行同步引闪。

保护功能

1. 热保护

- 为防止闪光灯过热并损坏，请勿在 1/1 功率时进行超过 60 次的快速连续闪光。60 次连续闪光后，要让闪光灯至少冷却 10 分钟。
- 如您在进行超过 60 次连续闪光后马上继续进行更多次闪光，内部的防过热功能可能会被激活，使回电时间变为 10 秒以上。如果发生这种现象，请让闪光灯冷却约 10 分钟，闪光灯便会恢复正常。
- 热保护启动后，显示屏上会显示符号 <  >

激活热保护功能的连续闪光次数：

闪光次数 \ 焦距	28mm	35mm	50mm	70mm	85mm
功率档位					
1/1	60	67	75	86	100
1/2	100	100	100	100	100
1/4	120	120	120	120	120
1/8	167	167	167	167	167
1/16	250	250	250	250	250
1/32	500	500	500	500	500
1/64	1000	1000	1000	1000	1000
1/128	2000	2000	2000	2000	2000
1/256	6000	6000	6000	6000	6000

高速同步模式下, 激活热保护功能的连续闪光次数

功率档位	连续闪光
1/1	60
1/2 (+0.1~+0.9)	70
1/4(+0.1~+0.9)	100
1/8(+0.1~+0.9)	
1/16(+0.1~+0.9)	
1/32(+0.1~+0.9)	
1/64(+0.1~+0.9)	
1/128(+0.1~+0.9)	
1/256(+0.1~+0.9)	

其他保护

为了保证设备安全的工作, 系统时刻进行预防保护, 以下提示符号供您参考:

屏幕显示	警示内容
Error1	闪光灯回电系统出现问题, 无法回电引闪, 请重新开机, 如无法解决请维修
Error3	闪光灯管两端电压过高, 请维修
Error5	闪光电路出现异常, 请维修
Error9	固件升级有误, 请进行正确固件升级

规格参数

型号	
无线从属单元模式	无线电模式（兼容 Canon, Nikon, Sony, Fuji, OM SYSTEM, Panasonic, Pentax, Leica）
闪光模式	无线关闭：M/Multi
	无线电从属：TTL/M/Multi
功率（1/1 档位）	100Ws
频闪闪光	具备（最高 90 次，99Hz）
同步方式	高速同步（最高 1/8000 秒），前帘同步，后帘同步
造型灯（LED）	2W, 亮度 1-10 级可调
光控引闪	S1/S2
无线闪光功能	从属单元功能
可控制从属单元组	16 组（A-F, 0-9）
传输距离	约 100 米
频道	32 个（1~32）
ID	01-99
电源	
电源	锂电池（7.2V/2850mAh）
电池充电接口	USB-C
全功率闪光次数	约 490 次
回电时间	约 0.01-1.5 秒
体积与重量	
体积（含电池）	122.3×76×76mm
净重（含电池）	564g

固件升级

- 本机通过 USB-C 固件升级接口可进行固件升级，软件最新公告及说明将会发布在官方网站上。
- 本品出厂不配 USB 升级线，请另行购买。本产品 USB 接口为 USB-C 接口，请使用 USB-C 线。
- 产品升级固件需要 Godox G3 程序软件支持，升级固件前请先到神牛官网下载安装“Godox G3 固件升级软件”再选择相应的固件文件。
- 由于产品进行固件升级，说明书请以最新电子版为准。

维护保养

- 闪光灯在工作时，如发现异常，应立即关掉电源，查明原因。
- 灯体应避免震动，平时注意表面除尘。
- 灯体稍有发热为正常现象，无特别需要时，勿连续引闪。
- 闪光灯的所有维修一概由本厂指定可供原厂配件之维修部负责。
- 1 年保修，消耗品如灯管等不在 1 年保修范围。
- 经发现，擅自检修此闪光灯的，将取消闪光灯之一年保修期，维修需要收取相关费用。
- 如果本品出现故障或者被水淋湿，在专业人员维修后方可继续使用。
- 如有技术更改，恕不另行通知。

Contents

Important Safety Instructions	26
Foreword	29
Main Features	29
Name of Parts	30
What's Inside	32
Separately Sold Accessories	33
Battery Instructions	33
Power Switch and Auto Off	36
Flash Mode	36
TTL Auto Flash	36
M Manual Flash	37
Multi Stroboscopic Flash	39
High-Speed Sync	40
Modeling Lamp	41
2.4G Wireless Transmission	42
Wireless Settings	42
Wireless Flash Shooting	43
Wireless Multiple Flash Shooting	43
The Reason & Solution of Not Triggering	44
Godox FT433 Function	45
C.Fn: Setting Custom Functions	46
Other Applications	47
Protection Function	47
Technical Data	50
Firmware Upgrade	51
Maintenance	51

Important Safety Instructions

This product is a professional photographic equipment, to be operated by professional personnel only. All transport protective materials and packaging on the product must be removed before use. The following basic safety precautions must be followed when using this product:

1. Carefully read and fully understand the instruction manual before use and strictly follow the safety instructions. Failure to do so may result in death, serious injury, damage to the product, or other property damage.
2. High voltage exists when the flash is powered on. Internal capacitors will remain charged for some time after power off.
3. This product is a professional lighting fixture, children are prohibited from using it. Children must be closely supervised by adults when approaching the fixture, to prevent collisions with the fixture or unauthorized use that could cause personal injury.
4. This is not an ordinary lighting fixture and must not be used for general illumination. Anyone with a history of eye damage or sensitivity should avoid using this fixture or looking directly at it.
5. Extreme caution must be exercised when using it, do not touch high-temperature parts such as flash tubes to avoid burns.
6. Do not point the flash directly at the eyes (especially baby's eyes) under any circumstances, as this could impair vision in a short time. Turn off immediately if discomfort occurs, stop using, and seek medical attention promptly.
7. If the flash tube is damaged, stop using it immediately and contact the manufacturer, service agent, or qualified repair personnel for a replacement to prevent accidents.
8. Do not use damaged equipment or accessories. Allow professional repair technicians to inspect and confirm normal operation before continuing use after repairs.
9. Disconnect power source or remove batteries (if it has one) before replacing flash tube, protective glass, or fuses. Allow 10 minutes to cool before replacing flash tube, and wear insulated or heat resistant gloves when operating.
10. Turn off power before connecting or disconnecting plugs from outlets. Ensure plugs are fully inserted when connecting.
11. Stop using immediately if the product shell is cracked due to falling, squeezing, or strong impact, to avoid touching the internal electronic components and getting an electric shock.
12. If an extension cord is needed, use the original extension cord or choose one with a rated current equal to or greater than the device. Using an extension cord with a smaller rated current may overheat and catch fire.
13. Some products have long power cords, please place them properly to avoid contact with heat sources or tripping others. It is recommended to use the original power cord. Damage caused by non-original cords is not covered by the warranty.

14. Unplug the equipment power plug from the power socket before cleaning or maintenance. Do not pull the power cord forcibly, use both hands to hold the plug end and pull it out.
15. This device is not waterproof. Keep it dry and avoid immersing it in water or other liquids. It should be installed in a ventilated and dry location and avoid using in rainy, humid, dusty, or overheated environments. Do not place items above the device or allow liquids to flow into it to prevent danger.
16. Do not disassemble without authorization. If the product malfunctions, it must be inspected and repaired by our company or authorized repair personnel.
17. Before storing the device, ensure it has completely cooled down and the power cord is unplugged, then put it in the protective case or a ventilated dry location.
18. Do not place the device near alcohol, gasoline, or other flammable volatile solvents or gases such as methane and ethane.
19. Do not use or store this device in potentially explosive environments.
20. Do not cover the heat dissipation port!
21. Do not use accessories not been approved by our company, as this may cause fire, electric shock or personal injury.
22. Clean gently with a dry cloth. Do not use a wet cloth as it may damage the device.
23. Some products are equipped with protective covers that must be removed before use.
24. This instruction manual is based on rigorous testing. Changes in design and specifications are subject to change without notice. Check official website for latest instruction manual and product updates.
25. Use only specified charger and follow proper usage instructions for certain products with built-in lithium batteries, within the rated voltage and temperature range.
26. Some products are powered by lithium batteries, who have limited lifespans and will gradually lose their charging capacities, which is irreversible. As the battery ages, the product's battery life will decrease. The lifespan of lithium battery is estimated to be 2 to 3 years. Please regularly check the battery, and if the charging time significantly increases or the battery life significantly decreases, consider replacing the battery.
27. Some products are equipped with lithium batteries. The following are the storage recommendations: Charge the battery to about 50% before storage. Charge it to about 50% at least every six months. Removable batteries should be stored separately. The storage temperature should be between 0°C and 40°C.
28. For products powered by lithium batteries. Please note:
 - Do not disassemble, crush, or puncture the battery;
 - Avoid short-circuiting the battery contacts;
 - Do not expose the battery to fire or water;
 - Do not expose the battery to temperatures above 60°C;
 - Keep out of reach of children;
 - Protect the battery from excessive shock or vibration;

- Do not use a damaged battery;
 - If the battery leaks, avoid contact with the leaking fluid;
 - If the battery fluid comes into contact with your eyes, immediately rinse with water for at least 15 minutes. Lift your eyelids until there are no signs of fluid and seek medical attention promptly.
29. Confirm and comply with all relevant local laws and regulations when handling any batteries.
 30. The warranty period for this device as a whole is one year. Consumables (such as batteries), adapters, power cords, and other accessories are not covered by the warranty.
 31. Unauthorized repairs will void the warranty and will incur charges.
 32. Please check the status and power of the lithium battery upon receipt. If there are any quality issues, please contact Godox or our authorized dealer within the warranty period.
 33. Failures from improper operation is not covered under warranty.
 34. The Battery is not allowed to be disassembled, hit, crushed or thrown into fire. Do not continue to use if it is seriously inflated. Do not place in a high temperature environment. Do not use after immersion in water.
 35. When using, it should be placed in a place where it is easy to dissipate heat, and should not be placed on the bedside, bedding, in a package or other environments that are not easy to dissipate heat. Keep out of contact with infants and young children, and children should use under adult guidance.

Foreword

Thank you for purchasing!

Pocket flash AD100Proll has 100Ws strong power, compact size and portable design. The built-in Godox 2.4G wireless X system is workable as a secondary flash in multi-flash system, and fully compatible with TTL auto flash of Canon, Nikon, Sony, Fujifilm, OM SYSTEM, Panasonic, Pentax cameras, making it an ideal light source for commercial photographers, journalists, photography enthusiasts, etc.

Main Features

- **Wireless TTL Compatibility:** Built-in Godox 2.4GHz and 433MHz dual-wireless system fully supports TTL/M/Multi flash systems of mainstream brand cameras.
- **Strong Power and Portability:** 100Ws strong power, pocket-size portable. Light body features an anti-slip texture for a more secure grip.
- **Upgraded Operations:** Colorful HD display panel, optimized button layout and interaction logic, achieve more intuitive and efficient operations.
- **Professional Power Solutions:** High-capacity lithium battery ensures quick recycling, and can be charged directly via the USB-C charging port.
- **Precise Lighting Control:** Power adjustable from 1/256 to 1/1 with 0.1 step fine-tuning, upto 1/8000s HSS, meeting various creative shooting needs
- **Distinct Group Indicators:** 16 groups with different color indicators ensure quick identification in multi-flash environments.

Name of Parts

Flash Body

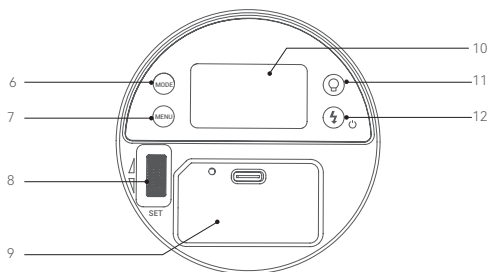
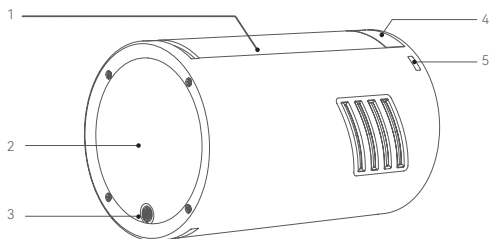

1. Shell (anti-slip texture)

2. Optical Lens

3. LED Modeling Lamp

4. Photocell Receiver

5. Group Indicator

6. MODE Button

7. MENU Button

8. SET Dial

9. Battery (with USB-C charging port)

10. Color Screen

11. Modeling Lamp Button

12. Test / Power Switch Button

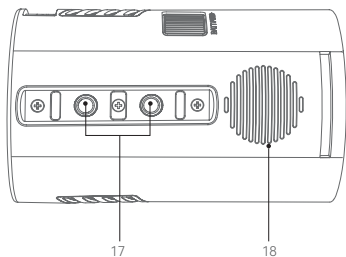
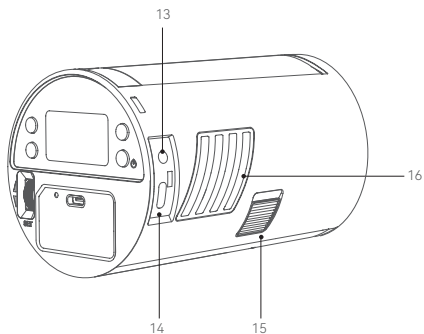

- 13. 3.5mm Sync Port
- 14. USB-C Firmware Upgrade / FT433 Port
- 15. Battery Detaching Pusher

- 16. Fan Inlet
- 17. 1/4" Mounting Hole
- 18. Fan Outlet

What's Inside

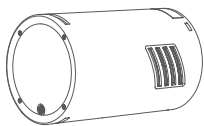

Flash Body × 1



Battery × 1



Adapter × 1



Portable Bag × 1



USB Charging Cable × 1



Holder AD-E2 × 1



Instruction Manual × 1

Separately Sold Accessories

Purchase more Godox accessories to achieve best photography effects:

Flash Trigger: XPro, X2T and X3 series.

Optical Accessories: Accessory kit for round flash head AK-R1, bracket S2 (compatible with Bowens mount accessories)

Universal Accessories: Softbox, beauty dish, umbrella diffuser, snoot, light stand, etc.

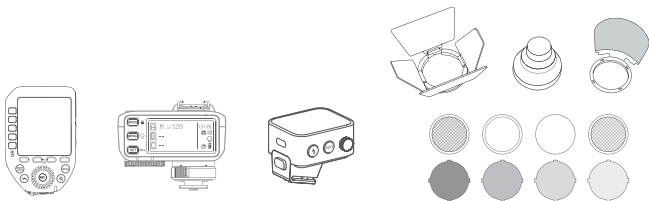

Battery Instructions

Features

1. This flash unit uses high-capacity li-ion battery which has long runtime. About 490 full power flashes in full battery level and 0.01-1.5s quick recycle time.
2. It is reliably safe. The inner circuit is against overcharge, overdischarge, overcurrent, and short circuit.
3. Take approx. 2h45min to fully charge the battery with the standard battery charger.

Cautions

1. Do not short circuit.
2. Do not expose to rain or immerse into water. This battery is not waterproof.
3. Keep out of reach of children.
4. No over 8 hours' continuous charging.
5. Store in dry, cool, ventilated places.
6. Do not put aside or into fire.
7. Dead batteries should be disposed according to local regulations.
8. Long time not to use, please charge it to 60% and then placed.
9. It is recommended to fully recharge the battery every three months.

Charging

Take out the battery from the flash body, charge it with the attached adapter and USB-C charging cable.

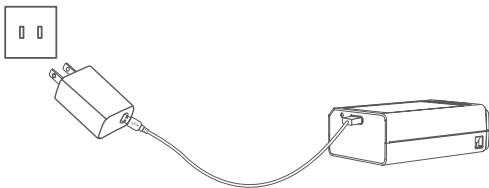

- Check the battery level through the battery level indication on the screen.

(Note: The battery level indication icon turning red means low battery, please charge in time.)



Loading and Unloading the Battery

Align the battery with the battery slot and insert in until a "click" sound is heard and the detaching pusher has been reset.

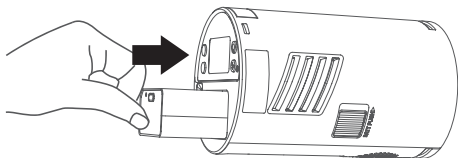

Toggle the battery detaching pusher in the direction as instructed, the battery will pop out automatically, catch it with your hands in case of falling.

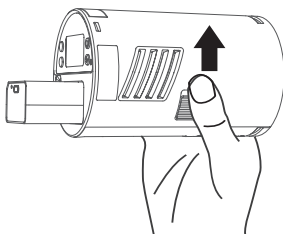

Power Switch and Auto Off

• **Power Switch:** Press and hold the [power switch/test button] to turn on or off the device. (Note: The screen will display “Rotate down to unlock” after powering on, and automatically power off after 6s of idle use.)

• **Auto Off:** In order to save battery power, users can adjust the auto off time of idle use in the menu settings among off, 30min, 60min, 90min and 120min. Disabling auto off function is recommended when the flash is used off-camera.

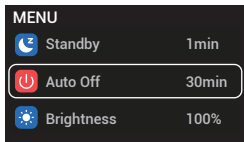

Flash Mode (TTL / M / Multi)

Press the [MODE button] to switch among M (manual)flash -> Multi (stroboscopic)flash-> TTL (auto) flash modes.

• TTL Auto Flash

In TTL mode, the camera's metering system detects the flash reflected from the subject and automatically adjusts the flash output so that the subject and background are evenly exposed. Users can adjust the flash exposure compensation (FEC) with a wireless flash trigger.

Note: TTL mode is only available when the wireless function is on.



1. Press the **[MENU button]** to enter menu interface, rotate and press the **[SET dial]** to select and enter wireless settings, turn the wireless function on. Set the group, channel and ID the same to the transmitter unit, then press the **[MENU button]** to return to the main interface.
2. Press the **[MODE button]** to switch to TTL flash mode.

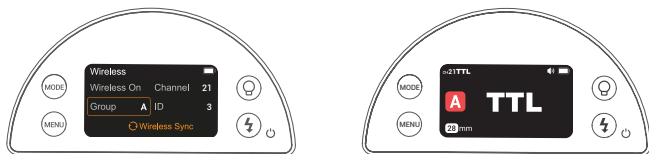

Focal Length Adjustment: Press the **[SET dial]** to enter focal length setting interface, then adjust the focal length by rotating the **[SET dial]**.

• M Manual Flash

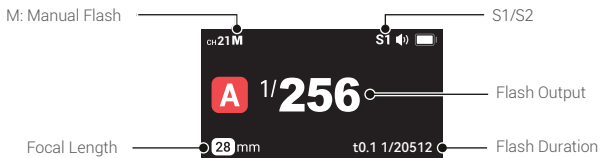

Flash Output Adjustment: Rotate the **[SET dial]** to adjust the flash output from 1/256 to 1/1 with 0.1 step increment.

Focal Length Adjustment: Press the **[SET dial]** to enter focal length setting interface, then adjust the focal length from 28mm to 85mm by rotating the **[SET dial]**.

Display Flash Duration

Flash duration refers to the length of time that from flash's firing to reach the half peak at maximum. The half peak at maximum is usually expressed as $t=0.5$. In order to provide the photographer with more concrete data, this product adopts $t=0.1$. The difference between $t=0.5$ and $t=0.1$ is shown in the following picture.

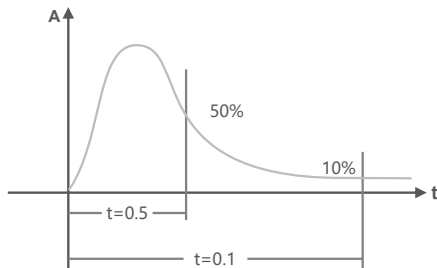

Note: Turn off the high-speed sync function in M mode, the flash duration will then be displayed.

Photocell (S1/S2)

Press the **[MENU button]** to enter menu interface, rotate and press the **[SET dial]** to select and enter photocell settings, then rotate the **[SET dial]** can choose among off, S1 and S2.

S1 Secondary Unit: The flash can function as an optical S1 secondary flash with optical sensor in M manual flash mode. With this function, the flash will fire synchronously when the main flash fires, the same effect as that by the use of wireless triggers. This helps create multiple lighting effects.

S2 Secondary Unit (pre-flash): The flash can also function as an optical S2 secondary flash with optical sensor in M manual flash mode. This is useful when cameras have pre-flash function. With this function, the flash will ignore a single "pre-flash" from the main flash and will only fire in response to the second, actual flash from the main unit.

Note: S1 and S2 optical triggering is only available in M manual flash mode.

● Multi Stroboscopic Flash

With stroboscopic flash, a rapid series of flashes is fired. It can be used to capture multiple images of a moving subject in a single photograph.

Multi: Stroboscopic
Flash



Flash Frequency

Number of Flashes

Flash Output Adjustment: Rotate the [SET dial] to adjust the flash output from 1/256 to 1/4.

Focal Length/Number of Flashes/Flash Frequency Adjustment:

Press the [SET dial] to enter focal length setting interface, then adjust the focal length by rotating the [SET dial].

Press the [SET dial] again to enter number of flashes setting interface, then adjust the number of flashes by rotating the [SET dial].

Press the [SET dial] again to enter flash frequency setting interface, then adjust the flash frequency by rotating the [SET dial].

Calculating the Shutter Speed

During stroboscopic flash, the shutter remains open until the firing stops. Use the formula below to calculate the shutter speed and set it with the camera.

Number of Flashes / Flash Frequency = Shutter Speed

For example, if the number of flashes is 10 and the firing frequency is 5 Hz, the shutter speed should be at least 2 seconds.

- Note: 1. Stroboscopic flash is most effective with a highly reflective subject against a dark background.
2. Using a tripod and a TTL flash trigger is recommended.
3. A flash output of 1/1 and 1/2 cannot be set for stroboscopic flash.



High-Speed Sync

High-speed sync (FP flash) enables the flash to synchronize with all camera shutter speeds. This is convenient when you want to use aperture priority for fill-flash portraits.

1. Press the **[MENU button]** to enter menu interface.
2. Rotate and press the **[SET dial]** to select and enter HSS settings, then rotate the **[SET dial]** can choose on or off. The <  > icon will be displayed on the screen after HSS is turned on.

Please use XPro, XProII, X2T and X3 series flash triggers.

Note:

- If you set a shutter speed that is the same as or slower than the camera's maximum flash sync speed, <  > will not be displayed in the viewfinder.
- With high-speed sync, the faster the shutter speed, the shorter the effective flash range.
- To return to normal flash, turn off the high-speed sync function in menu settings. Then <  > will disappear.
- Multi flash mode cannot be set in high-speed sync mode.
- Over-temperature protection may be activated after 60 consecutive high-speed sync flashes.

Modeling Lamp

Turning On the Modeling Lamp and Brightness Adjustment: Press the [modeling lamp button], then press the [SET dial] to turn on the modeling lamp as instructed on the screen. Rotate the [SET dial] can adjust the brightness of the modeling lamp.

Turning Off the Modeling Lamp: Press the [modeling lamp button] to enter brightness adjustment interface, press the [SET dial] can turn off the modeling lamp.

Note: Press and hold the [modeling lamp button] can turn on or off the modeling lamp.

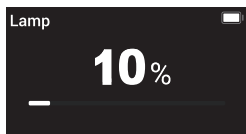
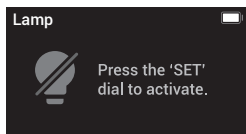

Mode Adjustment: Press the [MENU button] to enter menu interface. Rotate and press the [SET dial] to select and enter model settings, then rotate the [SET dial] can choose inter or cont.

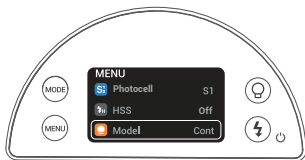

2.4G Wireless Transmission

AD100Proll adopts 2.4G wireless X system, which has good compatibility with other Godox products. It can automatically switch to receiver unit according to the transmitter unit instead of setting manually. The compatible cameras include Canon, Nikon, Sony, OM SYSTEM, Panasonic, Fujifilm, Pentax, Leica, etc.

As a receiver unit, AD100Proll can be controlled by the following transmitter units: XProll series/X3 series/X2T series /V1Pro series /V100 series /V860III series.

Wireless Settings

Press the **[MENU button]** to enter menu interface, rotate and press the **[SET dial]** to select and enter wireless setting interface.

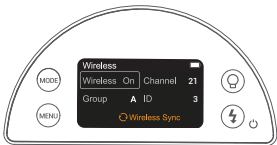

Parameters Settings: Press and rotate the **[SET dial]** can adjust the following parameters.

Wireless	On/Off
Channel	1-32
Group	0-9, A-F
ID	Off, 1-99
Wireless Sync	Approx. 100m wireless transmission

Note: If there are other wireless flash systems nearby, you can change the channel to prevent signal interference. The channels of the transmitter unit and the receiver unit(s) must be set to the same.

Take X3 flash trigger as an example:

1. Turn on the wireless function of AD100Proll, set the channel, group and ID.
2. Set the channel and ID in the wireless interface of X3 to the same as AD100Proll, start <Wireless Sync> on both ends to connect them.
3. Find the group in the main interface of X3 corresponding to AD100Proll, set the flash mode and output power.
4. Press camera shutter to trigger.

Operation Range

- Auto flash shooting with one receiver unit

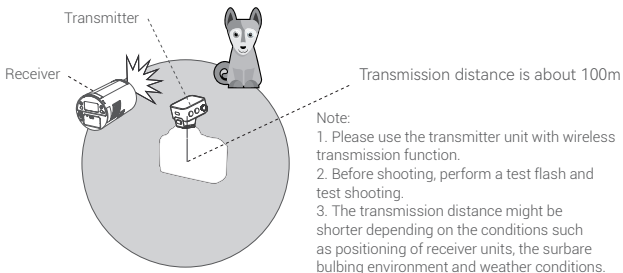

Wireless Multiple Flash Shooting

You can divide the receiver units into two or three groups and perform TTL auto flash while changing the flash ratio (factor). In addition, you can set and shoot with a different flash mode for each firing group.

- Auto flash shooting with two receiver units

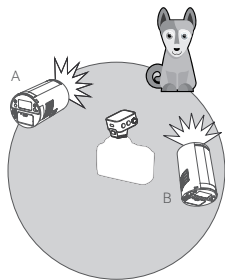

- Auto flash shooting with three receiver units

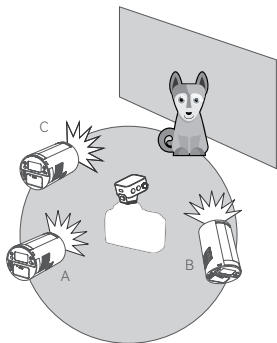

The Reason & Solution of Not Triggering

1. Disturbed by the outer environment (e.g. wireless base station, 2.4G wifi router, Bluetooth, etc.)

→ To adjust the channel CH setting on the flash trigger (add 10+ channels) and use the channel which is not disturbed. Or turn off the other 2.4G equipment in working.

2. Please make sure that whether the flash has finished its recycle or caught up with the continuous shooting speed or not (the flash ready indicator is lightened) and the flash is not under the state of over-heat protection or other abnormal situation.

→ Please downgrade the flash power output. If the flash is in TTL mode, please try to change it to M mode (a pre-flash is needed in TTL mode).

3. Whether the distance between the flash trigger and the flash is too close or not (< 0.5m).

→ Please turn on "short distance wireless mode" of the flash trigger.

→ X1 Series: Press and hold the triggering button then turn on the device, until the indicator blinks twice.

→ XPro and X2T Series: Please set the C.Fn-DIST to 0-30m.

→ X3 Series: Please set the triggering distance to 0-30m.

4. Whether the flash trigger and receiver unit are in the low battery states or not.

→ Please charge or replace the battery in time.

Godox FT433 Function

To create enhanced signal stability and anti-interference capabilities, and to achieve precise control of the flash, it is recommended to use Godox FT433 flash trigger. With built-in 433 MHz wireless module, the transmitter FT433 can be collocated with the receiver FR433 to achieve longer transmission distance while greatly decreasing the interference. FT433 is compatible with Canon, Nikon and Sony cameras, can control Godox flashes such as AD100ProII, AD200ProII, AD400ProII, AD600ProII and AD600BMII.

Operation Instructions



1. Turn off the flash trigger, camera and flash, mount the transmitter FT433 on camera hot shoe, insert the receiver FR433 into the USB-C port of AD100ProII. Rotate the antenna out from the top of the transmitter and receiver. Then, power on the flash trigger, camera and flash.
2. Set FT433: Press the **[MENU button]** and select <(●)> to set channel and ID. Then press the **[MENU button]** to return the main interface. Press **[MODE-LOCK button]** to set flash trigger mode, rotate the select dial to set flash trigger level.
3. Set AD100ProII: Press the **[MENU button]** to enter menu interface, rotate and press the **[SET dial]** to select and enter wireless setting interface, turn on wireless, set the same channel, group and ID to the flash trigger.
4. Press the camera shutter to trigger and the status lamp of the flash trigger turns red synchronously.

Note: Flash trigger FT433 is sold separately.

C.Fn: Setting Custom Functions

Press the [MENU button] to enter menu interface, rotate and press the [SET dial] to choose among the following functions, then rotate and press the [SET dial] to adjust its parameters. Press the [MENU button] to return to the previous interface.

Icons	Functions	Options	Notes
	Wireless	Off	Turn off wireless function
		On	Set channel, group and ID
	Photocell	Off	Turn off photocell
		S1	Turn on photocell in M mode
		S2	
	HSS	Off	Turn off high speed sync
		On	Turn on high speed sync in M mode
	Model	Inter	Modeling lamp off in triggering
		Cont	Modeling lamp constant on
	Beep	Off	Beep is off
		On	Beep is on
	Type	1/256	Flash step displays as 1/1 -1/256
		2.0	Flash step displays as 3.0 -10.0
	Standby	30sec	Screen blacks out in 30sec of idle use
		1min	Screen blacks out in 1min of idle use
		2min	Screen blacks out in 2min of idle use
		3min	Screen blacks out in 3min of idle use
	Auto Off	Off	Turn off auto off function
		30min	Auto off in 30min
		60min	Auto off in 60min
		90min	Auto off in 90min
		120min	Auto off in 120min
	Brightness	20%-100%	Turn the SET dial to adjust
	Delay	Off	Turn off delay flash
		0.01-30.0s	Turn the SET dial to adjust delay flash

	Language	Simplified Chinese	Simplified Chinese operating system
		English	English operating system
	Reset	Yes	Factory reset
		No	Cancel factory reset
	Device Info	/	Display the current model and version

Other Applications

The sync cord jack is a $\phi 3.5\text{mm}$ plug. Insert a sync cord or trigger plug in and the flash will be fired synchronously with the camera shutter.

Protection Function

1. Over-Temperature Protection

- To avoid overheating and deteriorating the flash head, do not fire more than 60 continuous flashes in fast succession at 1/1 full power. After 60 continuous flashes, allow a rest time of at least 10 minutes.
- If you fire more than 60 continuous flashes and then fire more flashes in short intervals, the inner over-temperature protection function may be activated and make the recycling time over 10 seconds. If this occurs, allow a rest time of about 10 minutes, and the flash unit will then return to normal.
- When the over-temperature protection is started, <  > is shown on the screen.

Number of flashes that will activate over-temperature protection:

Number of Flashes Focal Length Power Output Level	28mm	35mm	50mm	70mm	85mm
	1/1	60	67	75	86
1/2	100	100	100	100	100
1/4	120	120	120	120	120
1/8	167	167	167	167	167
1/16	250	250	250	250	250
1/32	500	500	500	500	500
1/64	1000	1000	1000	1000	1000
1/128	2000	2000	2000	2000	2000
1/256	6000	6000	6000	6000	6000

Number of flashes that will activate over-temperature protection in high-speed sync triggering mode:

Power Output Level	Number of Continuous Flashes
1/1	60
1/2 (+0.1~+0.9)	70
1/4(+0.1~+0.9)	100
1/8(+0.1~+0.9)	
1/16(+0.1~+0.9)	
1/32(+0.1~+0.9)	
1/64(+0.1~+0.9)	
1/128(+0.1~+0.9)	
1/256(+0.1~+0.9)	

2. Other Protections

The system provides real-time protection to secure the device and your safety. The following lists prompts for your reference:

Display	Meaning
Error1	A failure occurs on the recycling system so that the flash cannot fire. Please restart the flash unit. If the problem still exists, please send this product to a maintenance center.
Error3	The voltage on two outlets of the flash tube is too high. Please send this product to a maintenance center.
Error5	The flash circuit has malfunctioned. Please send this product to a maintenance center.
Error9	There are some errors occurred during the upgrading process. Please using the correct firmware upgrade method.

Technical Data

Model	AD100Proll
Wireless Receiver Unit Mode	Wireless Mode (compatible with Canon, Nikon, Sony, Fuji, OM SYSTEM, Panasonic, Pentax, Leica)
Flash Mode	Wireless off: M/Multi
	Wireless receiver mode: TTL/M/Multi
Power (1/1 step)	100Ws
Stroboscopic Flash	Provided (up to 90 times, 99Hz)
Sync Mode	High-speed sync (up to 1/8000 seconds), first-curtain sync, and second-curtain sync
Modeling Lamp (LED)	2W, brightness level 1-10
Photocell	S1/S2
Wireless Flash Function	Receiver
Controllable Receiver Groups	16: A-F, 0-9
Transmission Range	Approx. 100m
Channels	32: 1-32
ID	01-99
Power Supply	
Power Supply	Lithium battery (7.2V/2850mAh)
Battery Charging Port	USB-C
Full Power Flashes	Approx.490
Recycle Time	Approx.0.01 ~ 1.5s
Dimension and Weight	
Dimension (with battery)	4.81"×2.99"×2.99"
Net Weight (with battery)	≈ 564g

Specifications and data may subject to changes without notice.

Firmware Upgrade

- This flash supports firmware upgrade through the USB-C port. Update information will be released on our official website.
- Please use an USB-C cable (sold separately) for firmware upgrade.
- As the firmware upgrade needs the support of Godox G3 software, please download and install the "Godox G3 firmware upgrade software" from Godox official website before upgrading. Then, choose the related firmware file.
- Please refer to the latest electronic version of the instruction manual.

Maintenance

- Shut down the device immediately should abnormal operation be detected.
- Avoid sudden impacts and the product should be dedusted regularly.
- It is normal for the flash tube to be warm when in use. Avoid continuous flashes if unnecessary.
- Maintenance of the flash must be performed by our authorized maintenance department which can provide original accessories.
- This product, except consumables e.g. flash tube, is supported with a one-year warranty.
- Unauthorized service will void the warranty.
- If the product had failures or was wetted, do not use it until it is repaired by professionals.
- Changes made to the specifications or designs may not be reflected in this manual.

Warning

Operating frequency:2412.99MHz-2464.49MHz (only receive)

FCC Caution

This device complies with part 15 of the FCC Rules. Operation is subject to the following two conditions:

- (1) This device may not cause harmful interference, and
- (2) this device must accept any interference received, including interference that may cause undesired operation.

Any Changes or modifications not expressly approved by the party responsible for compliance could void the user's authority to operate the equipment.

IC Warning

This device complies with Industry Canada licence-exempt RSS standard(s). Operation is subject to the following two conditions:

- (1) This device may not cause interference, and
- (2) This device must accept any interference, including interference that may cause undesired operation of the device.

Le présent appareil est conforme aux CNR d'Industrie Canada applicables aux appareils radio exempts de licence. L'exploitation est autorisée aux deux conditions suivantes:

- (1) l'appareil ne doit pas produire de brouillage, et
- (2) l'utilisateur de l'appareil doit accepter tout brouillage radioélectrique subi, même si le brouillage est susceptible d'en compromettre le fonctionnement

产品保修

尊敬的用户，本保修卡是申请保修服务的重要凭证，请您配合销售商填写并妥善保管，谢谢！

产品信息	型号	产品条码
用户信息	姓名	联系电话
	通信地址	
销售商信息	名称	
	联系电话	
	通信地址	
	销售日期	
备注		

注：此表应由销售商盖章确认。

产品信息

本文件适用于相关《产品保修信息》(见后面说明)所列产品,其他非属此范围的产品或部件(如促销品、赠品及其他出厂后附加的部件等)不在此保修承诺内。

保修期

产品及部件的相应保修期按相关的《产品保修信息》执行。保修期自产品首次购买日起算，购买日以购买产品时保修卡登记日期为准。

如何获得保修服务

您可直接与产品销售商或授权服务机构联系，也可拨打神牛产品售后服务电话，与我们联系，由我们的服务人员为您安排服务。申请保修时，您应提供有效的保修卡作为保修凭证，方可获得保修。如您不能提供有效的保修卡，则在我们确认产品或部件属于保修范围的情况下，也可以为您提供保修，但这不作为我们的义务。

不适用保修情况

如产品存在下列情况，本文件项下的保证和服务将不适用：①产品或部件超过相应保修期；②错误或不当使用、维护或保管导致的故障或损坏，如：不当搬运；不按产品合理预期用途使用；不当插拔外接设备；跌落或外力挤压；接触或暴露于不适当温度、溶剂、酸碱、水浸或潮湿环境；③由非神牛授权机构或人员安装、修理、更改、添加或拆卸造成的故障或损坏；④产品或部件原有识别信息被修改变更或删除；⑤无有效保修卡；⑥使用非合法授权、非标准或非公开发行的软件造成的故障或损坏；⑦因不可抗力或意外事件造成的故障或损坏；⑧其他非因产品本身质量问题导致的故障或损坏。遇上述情况，您应向相关责任方寻求解决，神牛对此不承担任何责任。因非在保修期或保修范围内的部件、附件或软件导致产品不能正常使用的，不是保修范围内的故障。产品使用过程中正常的脱色，磨损和消耗，不是保修范围内的故障。

产品保修和服务支持信息

产品的保修期和服务类型按以下《产品保修信息》执行：

产品类别	选件名称	保修期(月)	保修服务类型
部件	电路板	12	客户送修
	电池	3	客户送修
	充电器等带电性能的部件。	12	客户送修
其他	如闪光管、造型灯泡、外壳、保护罩、锁紧装置、包装等。	无	无保修

神牛产品售后服务电话 0755-29609320-8062

Warranty

Dear customers, as this warranty card is an important certificate to apply for our maintenance service, please fill in the following form in coordination with the seller and safe-keep it. Thank you!

Product Information	Model	Product Code Number
Customer Information	Name	Contact Number
	Address	
Seller Information	Name	
	Contact Number	
	Address	
	Date of Sale	
Note		

Applicable Products

Applicable Products The document applies to the products listed on the Product Maintenance Information (see below for further information). Other products or accessories (e.g. promotional items, giveaways and additional accessories attached, etc.) are not included in this warranty scope.

Warranty Period

The warranty period of products and accessories is implemented according to the relevant Product Maintenance Information. The warranty period is calculated from the day (purchase date) when the product is bought for the first time, and the purchase date is considered as the date registered on the warranty card when buying the product.

How to Get the Maintenance Service

If maintenance service is needed, you can directly contact the product distributor or authorized service institutions. You can also contact the Godox after-sale service call and we will offer you service. When applying for maintenance service, you should provide valid warranty card. If you cannot provide valid warranty card, we may offer you maintenance service once confirmed that the product or accessory is involved in the maintenance scope, but that shall not be considered as our obligation.

Inapplicable Cases

The guarantee and service offered by this document are not applicable in the following cases:

① The product or accessory has expired its warranty period; ② Breakage or damage caused by inappropriate usage, maintenance or preservation, such as improper packing, improper usage, improper plugging in/out external equipment, falling off or squeezing by external force, contacting or exposing to the improper temperature, solvent, acid, base, flooding and damp environments, etc; ③ Breakage or damage caused by non-authorized institution or staff in the process of installation, maintenance, alternation, addition and detachment; ④ The original identifying information of product or accessory is modified, alternated, or removed; ⑤ No valid warranty card; ⑥ Breakage or damage caused by using illegally authorized, nonstandard or non-public released software; ⑦ Breakage or damage caused by force majeure or accident; ⑧ Breakage or damage that could not be attributed to the product itself. Once met these situations above, you should seek solutions from the related responsible parties and Godox assumes no responsibility. The damage caused by parts, accessories and software that beyond the warranty period or scope is not included in our maintenance scope. The normal discoloration, abrasion and consumption are not the breakage within the maintenance scope.

Maintenance and Service Support Information

The warranty period and service types of products are implemented according to the following Product Maintenance Information:

Product Type	Name	Maintenance Period(month)	Warranty Service Type
Parts	Circuit board	12	Customer sends the product to designated site
	Battery	3	Customer sends the product to designated site
	Electrical parts e.g.battery charger, etc.	12	Customer sends the product to designated site
Other Items	Power cord, Sync cord, flash tube, modeling lamp, shell, lamp cover, locking device, package, etc.	No	Without warranty

Godox After-sale Service Call 0755-29609320-8062