

合格证  
QC PASS

Godox

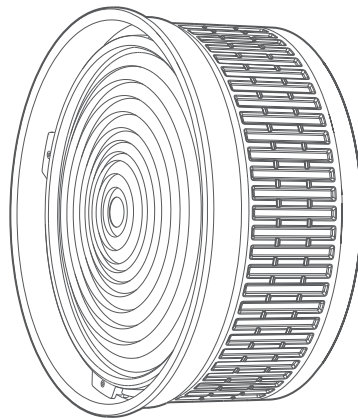

**FLS5**  
**FLS8**  
**FLS10**

**LED灯菲涅尔附件**

Fresnel Attachment for COB LED lights

**说明手册**

Instruction Manual



Wechat  
Official Account  
神牛微信公众号

**深圳市神牛摄影器材有限公司**

地址: 深圳市宝安区福海街道塘尾社区耀川工业区厂房2栋

电话: 0755-29609320(8062) 传真: 0755-25723423 邮箱: godox@godox.com

**GODOX Photo Equipment Co., Ltd.**

Add: Building 2, Yaochuan Industrial Zone, Tangwei Community, Fuhai Street, Bao'an District, Shenzhen 518103, China

Tel: +86-755-29609320(8062) Fax: +86-755-25723423 E-mail: godox@godox.com

**www.godox.com**

Made in China | 705-FLS800-02



## 前言

LED 灯菲涅尔附件 FLS10 和 FLS8 是两款带有保荣卡口的可调焦光学附件。FLS10 镜头内径尺寸为 10 英寸 (254mm)，FLS8 镜头内径尺寸为 8 英寸 (203mm)。FLS10 光线可调节角度为 10°-35°，FLS8 光线可调节角度为 10°-40°。FLS10 搭配摄影灯使用时，中心照度最小提高 4 倍 (泛光)，最大提高 19 倍 (聚光)。FLS8 搭配摄影灯使用时，中心照度最小提高 3 倍 (泛光)，最大提高 19 倍 (聚光)。通过旋转镜头中心的调焦转轮切换聚光与泛光。顺时针旋转，LED 灯菲涅尔附件拉长，光斑变小，照度增强。逆时针旋转，LED 灯菲涅尔附件缩短，光斑变大，照射范围广。另购八叶挡光板 LB-01/LB-02 实现随意塑光效果，极大满足了摄影师的光效需求。

LED 菲涅尔附件 FLS5 是专配神牛卡口的可调焦光学附件，光线可调节角度为 10°-35°，搭配八叶挡光板 LB-03 可实现更好的场景光效。

LED 灯菲涅尔附件 FLS10 适用神牛保荣卡口 LED 摄影灯。

LED 灯菲涅尔附件 FLS8 适用除 M600D、M600Bi 之外的神牛保荣卡口 LED 摄影灯。

LED 菲涅尔附件 FLS5 适用神牛卡口 LED 摄影灯。

## 警告

- △ 搭配 LED 摄影灯使用时，请勿将光源对准人的眼睛，以免造成伤害。
- △ LED 灯菲涅尔附件属于易碎物品，请轻放轻拿，避免撞击造成损坏！
- △ 搭配 LED 摄影灯使用时，请注意壳体高温！
- △ 请固定好 LED 灯菲涅尔附件，才能进行调焦操作！

## 部件

### LED 灯菲涅尔附件

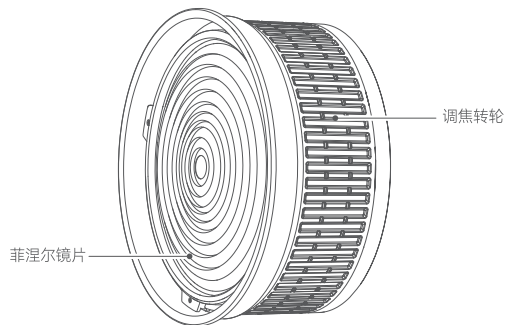

### 八叶挡光板

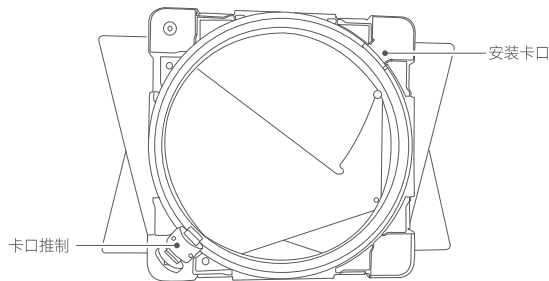

注：FLS10、FLS8 标配物品不包含八叶挡光板，FLS5 标配物品包含八叶挡光板。

## 物品清单

### LED 灯菲涅尔附件 FLS10



LED 灯菲涅尔附件  
FLS10  
x1



便携包  
CB43  
x1



说明书  
x1

### LED 灯菲涅尔附件 FLS8



LED 灯菲涅尔附件  
FLS8  
x1



便携包  
CB44  
x1



说明书  
x1

### LED 灯菲涅尔附件 FLS5



LED 灯菲涅尔附件  
FLS5  
x1



八叶挡光板  
LB-03  
x1



便携包  
CB86  
x1



说明书  
x1

## 另购附件

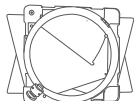

八叶挡光板 LB-02  
(适用于 FLS10)

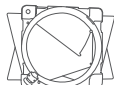

八叶挡光板 LB-01  
(适用于 FLS8)

## 安装 (以神牛 SL150II 为例)

对准 SL150II 卡口插入, 顺时针旋转即可安装完毕。

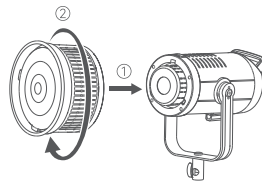

## 拆卸 (以神牛 SL150II 为例)

推动 SL150II 卡口推制, 将 LED 灯菲涅尔附件逆时针旋转即可拆卸。

注: 以上步骤, 三种机型都适用。不同之处: FLS10、FLS8 适配保莱卡口, FLS5 适配神牛卡口。

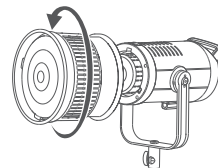

## 八叶挡板安装说明

1. 先将菲涅尔镜头安装到 LED 摄影灯上。

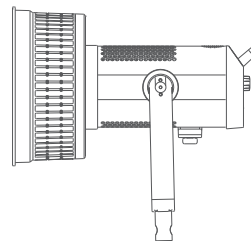

2. 用八叶挡板安装卡口卡住 LED 灯菲涅尔附件边缘, 接着用手拉开八叶挡板卡口推制, 待挡板边缘紧靠 LED 灯菲涅尔附件边缘后, 放开卡口推制即可安装完毕。

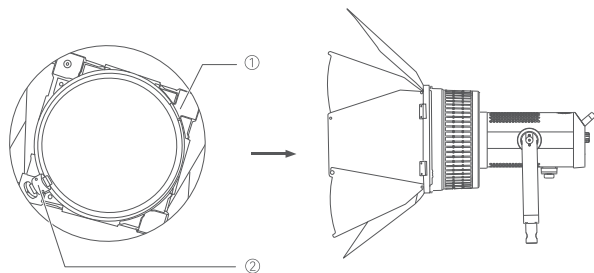

① 先用这个安装卡口卡住 LED 灯菲涅尔附件边缘

② 拉开八叶挡板卡口推制

注: 安装八叶挡板时, 请带厚手套操作, 以免造成刮伤。建议拴好保险钢丝绳, 以免挡光板脱落。

### LED 灯菲涅尔附件 FLS10 中心照度分布图 (搭配 M600D)

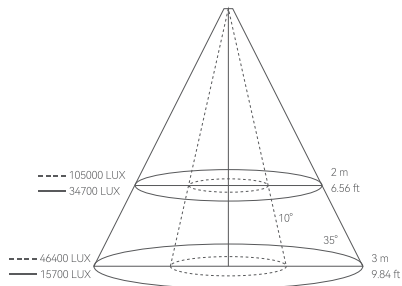

上述数据为搭配 M600D 使用时的平均照度值, 非绝对值, 不同灯之间存在微小差异。

---- 虚线 聚光

—— 实线 泛光

### LED 灯菲涅尔附件 FLS8 中心照度分布图 (搭配 VL300)

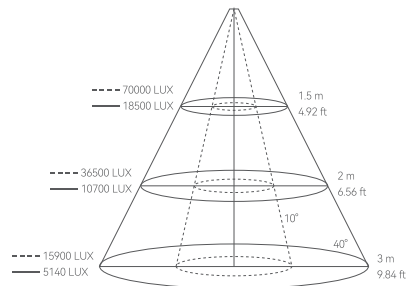

上述数据为搭配 VL300 使用时的平均照度值, 非绝对值, 不同灯之间存在微小差异。

---- 虚线 聚光

—— 实线 泛光

### LED 灯菲涅尔附件 FLS5 中心照度分布图 (搭配 ML60)

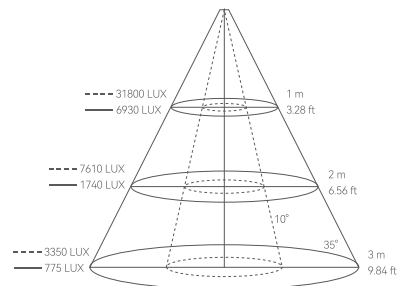

上述数据为搭配 ML60 使用时的平均照度值, 非绝对值, 不同灯之间存在微小差异。

---- 虚线 聚光

—— 实线 泛光

## 规格参数

名称	LED 灯菲涅尔附件		
型号	FLS10	FLS8	FLS5
光线可调角度	10°-35°	10°-40°	10°-35°
工作环境温度	-10°C~40°C	-10°C~40°C	-10°C~40°C
适用摄影灯功率	≤600W	≤300W	≤60W
适用摄影灯卡口	神牛保菜卡口	除M600D、M600Bi之外的神牛保菜卡口	神牛卡口
尺寸	295mm*295mm*135mm	246mm*246mm*121mm	147mm*147mm*61mm
净重≈	3kg	2kg	0.42kg

## Foreword





FLS10 and FLS8 are focusable optical accessories with Bowens mount. The inner diameters of FLS10 and FLS8 are 10 inches (254mm) and 8 inches (203mm), their adjustable light angles are 10°-35° and 10°-40° respectively. When collocating with video lights, the center illuminance of FLS10 and FLS8 increase 4 (flood) to 19 (spot) times and 3 (flood) to 19 (spot) times respectively. Spotting light effect and flooding light effect are switchable by rotating the focusing dial in the center of the lens. The Fresnel Attachment extends, the light spot becomes smaller and illuminance increases if you rotate clockwise, while the Fresnel Godox LED lights, retracts, the light spot becomes larger, and the irradiation range is wide, if you rotate counterclockwise. The separately sold Barn Door LB-01/LB-02 can help achieve better light effects. Fresnel Attachment FLS5 is a focusable optical accessory exclusively for the Godox-mount. Its adjustable light angle is 10° to 35°. With Barn Door LB-03, you can achieve better light effect.

FLS10 is compatible with Godox LED lights with Bowens mount.

FLS8 is compatible with Godox LED lights with Bowens mount except for M600D and M600Bi.

FLS5 is compatible with Godox LED lights with Godox-mount.

## Warning

-  When collocating with LED lights, do not use against the eyes. Otherwise visual impairment may occur.
-  Fresnel Attachment is fragile, please be careful and avoid crashes!
-  Be ware of high temperature when using collocating with LED lights!
-  Please focus after the Fresnel Attachment is securely fixed!

## Name of parts

### Fresnel Attachment for COB LED Lights

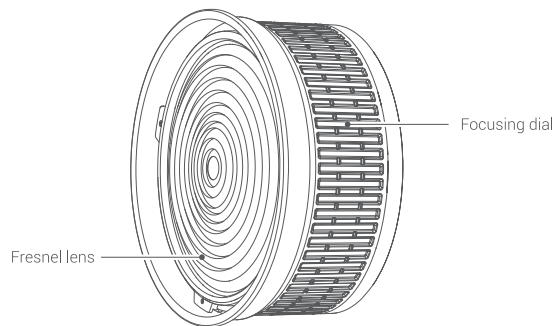

### Barn Door

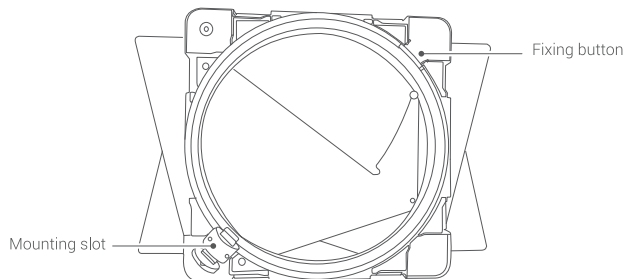

Note: FLS10, FLS8 standard items do not include barn door, FLS5 standard items include barn door.

## Included Items

### FLS10 Fresnel Attachment for COB LED Lights



FLS10  
x1



Portable Bag  
CB43  
x1



Instruction  
Manual  
x1

### FLS8 Fresnel Attachment for COB LED Lights



FLS8  
x1



Portable Bag  
CB44  
x1



Instruction  
Manual  
x1

### FLS5 Fresnel Attachment for COB LED Lights



FLS5  
x1



Barn Door  
LB-03  
x1



Portable Bag  
CB86  
x1



Instruction  
Manual  
x1

## Separately Sold Accessories

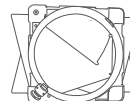

Barn Door LB-02  
Suitable for FLS10

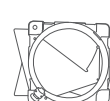

Barn Door LB-01  
Suitable for FLS8

## Installing Instruction (take Godox SL150II as an example)

Insert into the mount of SL150II and rotate clockwise to install the Fresnel Attachment.

Note: The above steps are applicable to all three models. Difference: FLS10 and FLS8 are suitable for Bowens-mount, while FLS5 is suitable for Godox-mount.

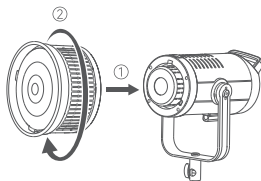

## Detaching Instruction (take Godox SL150II as an example)

Push the fixing button of SL150II, then rotate counterclockwise to detach the Fresnel Attachment.

Note: The above steps are applicable to all three models. Difference: FLS10 and FLS8 are suitable for Bowens-mount, while FLS5 is suitable for Godox-mount.

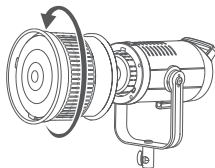

## Barn Door Installation Instruction

1. Install the Fresnel attachment to the LED light.

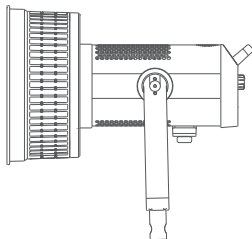

2. Align the mounting slot of barn door with the edge of Fresnel Attachment, pull the fixing button and release it to buckle up.

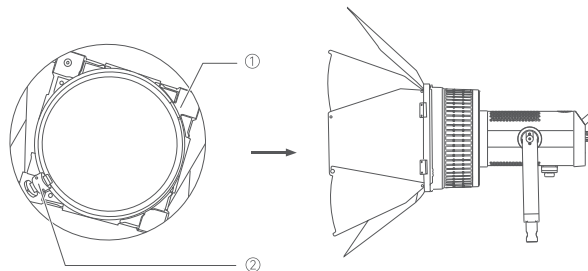

① Align the mounting slot of barn door with the edge of Fresnel Attachment

② Pull the fixing button

Note: The Barn Door should be installed with gloves to avoid scratches. It is suggested to secure the safety rope to avoid falling of the Barn Door.

## Center Illuminance Diagram of FLS10 (collocate with M600D)

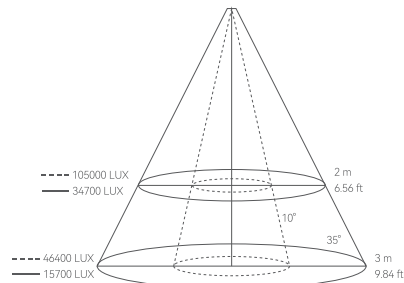

The above data is average illuminance instead of absolute illuminance when collocated with M600D, and there are differences between different lights.

---- spot

— flood

## Center Illuminance Diagram of FLS8 (collocate with VL300)

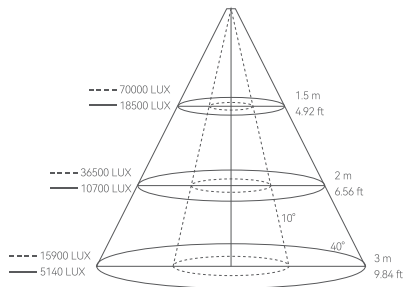

The above data is average illuminance instead of absolute illuminance when collocated with VL300, and there are differences between different lights.

----- spot  
 ——— flood

## Center Illuminance Diagram of FLS5 (collocate with ML60)

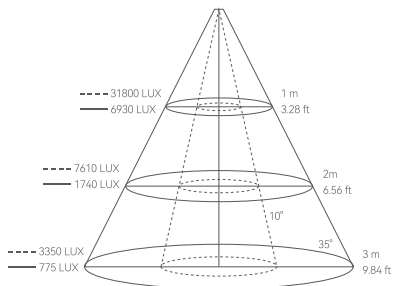

The above data is average illuminance instead of absolute illuminance when collocated with ML60. There are differences in illumination between different lights.

----- spot  
 ——— flood

## Technical Data

Product Name	Fresnel Attachment for COB LED Lights		
Model	FLS10	FLS8	FLS5
Adjustable Light Angle	10°-35°	10°-40°	10°-35°
Working Environment Temperature	-10°C~40°C	-10°C~40°C	-10°C~40°C
Suitable LED Light Power	≤600W	≤300W	≤60W
Suitable LED Light Mount	Godox Bowens mount	Godox Bowens mount except for M600D/M600Bi	Godox mount
Dimension	295mm*295mm*135mm	246mm*246mm*121mm	147mm*147mm*61mm
Net Weight≈	3kg	2kg	0,42kg



## 产品保修

尊敬的用户，本保修卡是申请保修服务的重要凭证，请您配合销售商填写并妥善保管，谢谢！

产品信息	型号	产品条码
用户信息	姓名	联系电话
	通信地址	
销售商信息	名称	
	联系电话	
	通信地址	
	销售日期	
备注		

注：此表应由销售商盖章确认。

### 适用产品

本文件适用于相关《产品保修信息》(见后面说明)所列产品，其他非属此范围的产品或部件(如促销品、赠品及其他出厂后附加的部件等)不在此保修承诺内。

### 保修期

产品及部件的相应保修期按相关的《产品保修信息》执行。保修期自产品首次购买日起算，购买日以购买产品时保修卡登记日期为准。

### 如何获得保修服务

要保修服务，您可直接与产品销售商或授权服务机构联系，也可拨打神牛产品售后服务电话，与我们联系，由我们的服务人员为您安排服务。申请保修时，您应提供有效的保修卡作为保修凭证，方可获得保修。如您不能提供有效的保修卡，则在我们可确认产品或部件属于保修范围的情况下，也可以为您提供保修，但这不作为我们的义务。

### 不适用保修的情况

如产品存在下列情况，本文件项下的保证和服务将不适用 ①产品或部件超过相应保修期；②错误或不当使用、维护或保管导致的故障或损坏，如：不当搬运；非按产品合理预期用途使用；不当插拔外接设备；跌落或外力挤压；接触或暴露于不当温度、溶剂、酸碱、水浸或潮湿环境；③由非神牛授权机构或人员安装、修理、更改、添加或拆卸造成的故障或损坏；④产品或部件原有识别信息被修改变更或删除；⑤无有效保修卡；⑥使用非合法授权、非标准或非公开发行的软件造成的故障或损坏；⑦因不可抗力或意外事件造成的故障或损坏；⑧其他非因产品本身质量问题导致的故障或损坏。遇上述情况，您应向相关责任方寻求解决，神牛对此不承担任何责任。因非在保修期或保修范围内的部件、附件或软件导致产品不能正常使用的，不是保修范围内的故障。产品使用过程中正常的脱色，磨损和消耗，不是保修范围内的故障。

## 产品保修和服务支持信息

产品的保修期和服务类型按以下《产品保修信息》执行：

产品类别	选件名称	保修期(月)	保修服务类型
部件	电路板	12	客户送修
	电池	3	客户送修
	充电器等带电性能的部件	12	客户送修
其他	如闪光灯、造型灯泡、外壳、保护罩、锁紧装置、包装等。	无	无保修

神牛产品售后服务电话：0755-29609320-8062

## Warranty

Dear customers, as this warranty card is an important certificate to apply for our maintenance service, please fill in the following form in coordination with the seller and safekeep it. Thank you!

Product Information	Model	Product Code Number
Customer Information	Name	Contact Number
	Address	
Seller Information	Name	
	Contact Number	
	Address	
	Date of Sale	
Note:		

Note: This form shall be sealed by the seller.

### Applicable Products

The document applies to the products listed on the Product Maintenance Information (see below for further information). Other products or accessories (e.g. promotional items, giveaways and additional accessories attached, etc.) are not included in this warranty scope.

### Warranty Period

The warranty period of products and accessories is implemented according to the relevant Product Maintenance Information. The warranty period is calculated from the day(purchase date) when the product is bought for the first time, And the purchase date is considered as the date registered on the warranty card when buying the product.

### How to Get the Maintenance Service

If maintenance service is needed, you can directly contact the product distributor or authorized service institutions. You can also contact the Godox after-sale service call and we will offer you service. When applying for maintenance service, you should provide valid warranty card. If you cannot provide valid warranty card, we may offer you maintenance service once confirmed that the product or accessory is involved in the maintenance scope, but that shall not be considered as our obligation.

### Inapplicable Cases

The guarantee and service offered by this document are not applicable in the following cases: (1). The product or accessory has expired its warranty period; (2). Breakage or damage caused by inappropriate usage, maintenance or preservation, such as improper packing, improper usage, improper plugging in/out external equipment, falling off or squeezing by external force, contacting or exposing to the improper temperature, solvent, acid, base, flooding and damp environments, etc; (3). Breakage or damage caused by non-authorized institution or staff in the process of installation, maintenance, alternation, addition and detachment; (4). The original identifying information of product or accessory is modified, alternated, or removed; (5). No valid warranty card; (6). Breakage or damage caused by using illegally authorized, nonstandard or non-public released software; (7). Breakage or damage caused by force majeure or accident; (8). Breakage or damage that could not be attributed to the product itself. Once met these situations above, you should seek solutions from the related responsible parties and Godox assumes no responsibility. The damage caused by parts, accessories and software that beyond the warranty period or scope is not included in our maintenance scope. The normal discoloration, abrasion and consumption are not the breakage within the maintenance scope.

## Maintenance and Service Support Information

The warranty period and service types of products are implemented according to the following Product Maintenance Information:

Product Type	Name	Maintenance Period(month)	Warranty Service Type
Parts	Circuit Board	12	Customer sends the product to designated site
	Battery	3	Customer sends the product to designated site
	Electrical parts e.g.battery charger, etc.	12	Customer sends the product to designated site
Other Items	Flash tube, modeling lamp, lamp body, lamp cover, lockingdevice, package, etc.	No	Without warranty

Godox After-sale Service Call 0755-29609320-8062