

合格证
QC PASS

Godox

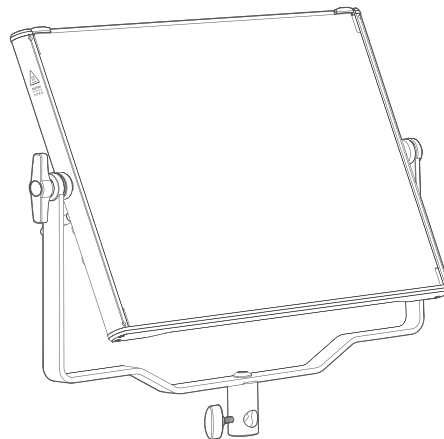

Wechat
Official Account
神牛微信公众号

深圳市神牛摄影器材有限公司

地址：深圳市宝安区福海街道塘尾社区耀川工业区厂房2栋

电话：0755-29609320(8062) 传真：0755-25723423 邮箱：godox@godox.com

GODOX Photo Equipment Co., Ltd.

Add.: Building 2, Yaochuan Industrial Zone, Tangwei Community, Fuhai Street, Bao'an District, Shenzhen

518103, China Tel: +86-755-29609320(8062) Fax: +86-755-25723423 E-mail: godox@godox.com

www.godox.com

Made in China | 705-P12000-00



P120D/P120Bi

神牛单色温 / 双色温 LED 影视平板灯
Godox Daylight / Bi-color LED Light panel

使用手册
Instruction Manual

重要的安全说明及注意事项

首先作为最基本原则：本产品为专业灯光布景设备，应由专业灯光师使用或在专业人士指导下使用。使用时必须始终遵循基本的安全预防措施，具体安全预防措施如下：

1. 使用前必须阅读并理解产品说明书。
2. 专业灯具，禁止儿童使用。当儿童靠近时，家长或监护人必须密切监督，以免儿童因碰撞灯具或私用灯具造成人身伤害。
3. 本灯具并非普通照明灯具，不可用于普通照明，任何有过眼部损伤或眼部敏感的人群均应避免使用本灯具。
4. 灯具点亮时，必须小心使用，禁止接触高温部件，如 LED 灯珠，以免造成灼伤。
5. 灯具点亮时，任何情况下均禁止直视灯珠。应该在专业灯光师指导下使用强光，任何情况下避免长时间处于强光环境，如引起眼睛不适，请及时关闭灯具，暂停使用，请及时就医。
6. 若灯珠损坏或因热变形，应停止使用，并及时联系制造商、服务代理商或合格的维修人员更换灯珠，以免发生意外。
7. 本产品仅适用于 -20°C ~ 45°C 工作环境温度及正常湿度环境下使用。
8. 请勿使用损坏的设备或设备配件，待专业维修人员检查维修，确认设备正常方可使用。
9. 在使用过程中，如果本产品由于跌落、受到挤压或遭受强烈冲击而造成外壳破裂的，请勿继续使用，以免因接触到内部电子元件而受到电击伤害。
10. 如需要延长线，请使用额定电流 \geq 该设备额定电流的延长线。如延长线额定电流小于该设备，可能导致过热。
11. 部分产品电源线较长，请合理放置电源线，使其处于安全位置。避免电源线接触过热物体表面。避免放置不当导致拉扯损坏或绊倒现场人员。请使用原厂电源线，如使用非原厂电源线导致产品损坏，一概不在本厂维修范围内。
12. 在清洁和维修之前，请务必从电源插座上拔下该设备插头。不使用时，禁止拉扯电源线以将设备插头从电源插座中拔出。正常断电，应是用手抓住该设备插头两端，将插头从电源插座中拔出。此设备需连接到接地插座中。
13. 本设备没有防水性能，请让设备保持干燥，请勿将本设备浸入水中或其他液体中。设备需安装在干燥且通风处，避免在雨天、潮湿、多尘或过热环境下使用。请勿将任何物体置于灯具上或使液体流入灯具内部，以免发生意外。
14. 请勿私自拆卸产品，如产品出现故障，须由本公司或授权的维修人员进行检查维修。
15. 存放本设备之前，请确保设备已完全冷却。存放时，将电源线从设备上拔出。设备应放置于设备便携包内或通风干燥处。
16. 请勿将设备放置在酒精、汽油等易燃挥发的溶剂附近。
17. 本厂不推荐的产品附件，请勿使用，以免导致火灾、触电或人身伤害。
18. 清洁本设备时，请勿用湿布擦拭，请用干布，软布擦拭设备污垢。
19. 设备使用前，请注意将保护罩取下。

20. 本产品已通过 ROHS, CE 和 FCC 认证，请参考相关国家标准使用和操作。

21. 安全说明依据本厂严格测试制定，设备设计和规格如有变更，恕不另行通知。客户可以上神牛官网查看最新的电子版说明，了解产品最新资讯。
22. 部分产品内置锂电池，此类产品请使用专用的充电器进行充电，并且按正确的操作说明，在规定的电压、温度范围内使用。
23. 部分产品使用电池供电，此类产品请勿使用说明书中未指定的任何电池、电源或附件。请将电池和其他附件置于儿童及婴幼儿无法触及之处。如果儿童或婴幼儿吞下电池或附件，请立即就医。如果电池漏液、变色、变形、冒烟或发出异味，请立即将其取出。在取出过程中请小心，以免烫伤。如果继续使用，可能会引起火灾、触电或皮肤烫伤。请勿使用任何变形或改造过的电池。请勿拆卸或改造本产品或电池，请勿加热电池或焊接电池。请勿让电池与火或水接触。请勿让电池受到强烈的外力撞击。请勿将电池的正负端错误插入，或将新旧电池或不同类型的电池混合使用。
24. 一年保修期，消耗品电池、适配器、电源线等配件不在此保修范围内。
25. 经发现，擅自检修设备，将取消一年保修期，维修需要收取相关费用。
26. 对于不规范操作引起的机器故障不在保修范围内。

保存这些说明

P120Bi 本设备包含型号核准代码为：CMIIT ID: 24J44811A006，为该产品的无线电发射模块。

P120D 本设备包含型号核准代码为：CMIIT ID: 24J44811A008，为该产品的无线电发射模块。

前言

感谢您购买神牛产品。神牛全新推出两款单 / 双色温 LED 影视平板灯，单色温与双色温版本可任意选择；两款 LED 影视平板灯均支持 AC 供电并带 V 口电池接口，支持蓝牙控制 / DMX512 控制；适用于新闻演播室、虚拟演播室、访谈演播室等场景。

主要特点

- 支持无极调节亮度，可调范围：0% -100%
- 支持蓝牙 /DMX512 控台控制 / 灯体控制
- 含可拆卸遮菲与柔光板，一体式发光面构造
- 两种供电方式：支持 AC 供电或 V 口电池供电
- P120D 固定色温 5600K 白光
- P120Bi 可调冷暖色温，范围：3200K-5600K



警告

- ⚠ 请勿私自拆卸产品，如产品出现故障须由本公司或授权的维修人员进行检查维修。
- ⚠ 本产品不能防水，在雨天及潮湿的环境下注意防水。
- ⚠ 在不使用时，请断开电源。
- ⚠ 使用 AC 电源线供电，串联的灯具请勿超过五台。

部件名称

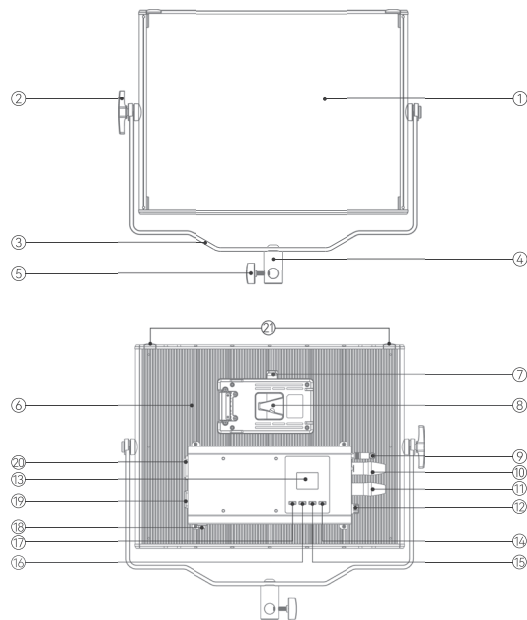

- | | | |
|-----------|----------------|------------------|
| 1. 发光面 | 8. V 口电池槽 | 15. MODE 按键 |
| 2. 支架调节旋钮 | 9. 天线接口 | 16. 蓝牙按键 |
| 3. U 型支架 | 10. DMX OUT 接口 | 17. INFO 按键 |
| 4. 套筒 | 11. DMX IN 接口 | 18. 开关按键 |
| 5. 套筒旋钮 | 12. SET 调节旋钮 | 19. AC INPUT 接口 |
| 6. 散热面 | 13. 显示屏 | 20. AC OUTPUT 接口 |
| 7. 电池拆卸按钮 | 14. DMX 按键 | 21. 拆装推钮 (左右各一) |

P120D/P120Bi 物料清单

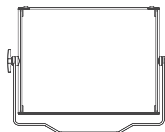

带 U 架灯体 x1



柔光板 x1

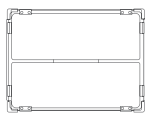

四叶遮菲 x1



AC 电源输入插头 x1



AC 电源输出插头 x1



DMX IN 五芯卡
侷头 x1



DMX OUT 五芯卡
侷头 x1



AC 电源线 x1



灯具吊柄 x1



安全绳 x1



说明书 x1

P120D K1/P120Bi K1 物料清单

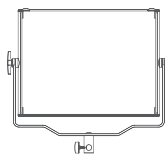

带 U 架灯体 x1



柔光板 x1

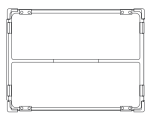

四叶遮菲 x1



AC 电源线 x1



箱包 x1



安全绳 x1



说明书 x1

P120D K2/P120Bi K2 物料清单

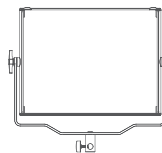

带 U 架灯体 x3



柔光板 x3

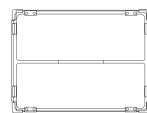

四叶遮菲 x3



AC 电源线 x3

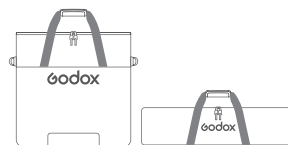

箱包 1+1



安全绳 x3



支架 304 x3



说明书 x1

另购附件

蜂巢 Gh50-P120

供电方式

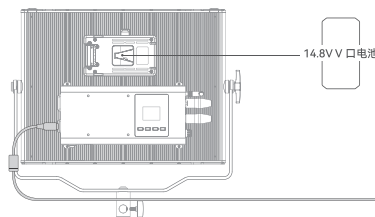

1. V 口电池供电

可插入一节 14.8V 的 V 口电池供电
注: V 口电池需另购

2. AC 供电

100V-240V ~ 50/60Hz

开机 / 关机

1. 插入一节 V 口 电池后，拨动开关按键至 <-> 即可实现开机。
2. 通过 AC 电源线接通电源，拨动开关按键至 <=> 即可实现开机。
3. 无论处于哪种供电方式，拨动开关按键至 <0> 即可实现关机。



操作说明

1. DMX 设置

短按 DMX 按键进入 DMX 设置界面，旋转 SET 调节旋钮选择 DMX 地址 (1-512)

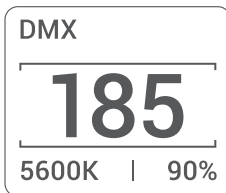

DMX 连接展示

注：仅展示 DMX 连接方式，DMX 转接线和 DMX512 控制台需另购。

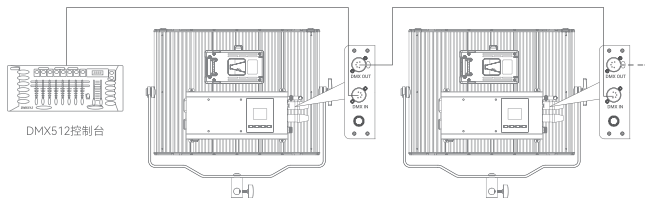

DMX 实用表

模式名称	通道	功能	DMX数值	参数
CCT 8bit	1	亮度	0 - 255	0% - 100%
	2	色温	0 - 255	3200K - 5600K

注：P120Bi 双色温版本才可调色温

2. 亮度 / 色温设置

P120D 单色温：短按 MODE 按键进入亮度设置界面，旋转 SET 调节旋钮调节亮度值，调节范围：0% -100% 或 0-255，通过短按 MODE 按键切换不同亮度值显示。
单色温版本固定色温为 5600K，不支持色温调节。

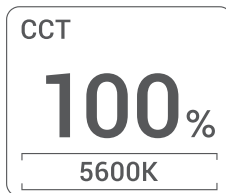

P120Bi 双色温：短按 MODE 按键进入亮度 / 色温设置界面，旋转 SET 调节旋钮调节亮度值，调节范围：0% -100% 或 0-255，通过短按 MODE 按键切换不同亮度值显示。
设置完毕短按 SET 调节旋钮跳入色温调节栏，旋转 SET 调节旋钮调节色温值，调节范围：3200K-5600K。

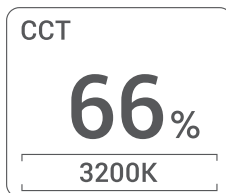

3. 蓝牙设置

短按蓝牙按键进入蓝牙设置界面，旋转 SET 调节旋钮选择蓝牙开启或关闭，设置完成短按 SET 调节旋钮可跳入下一栏的蓝牙重置或取消，MAC 码位于界面下方，便于快速找到灯具进行匹配。

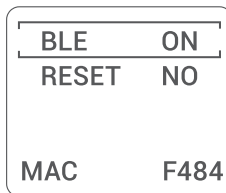

“Godox Light”App 下载
扫描下面二维码即可下载“Godox Light”手机 app（安卓和苹果系统都可使用）。

1. 首个移动设备（手机或平板电脑）可直接使用 app 操控灯体。更换其他移动设备时，灯体需进行蓝牙重置方可正常使用 app。
2. App 需升级至 V3.0 以上版本。



4. 灯具信息

短按 INFO 按键进入灯具信息界面，可查看当前灯具固件版本号。



安装 / 拆卸遮菲与柔光板

1. 安装：将遮菲与柔光板顺着安装凹槽处平行卡入，上推两侧拆装推钮，听到“咔”一声响起即安装完毕。

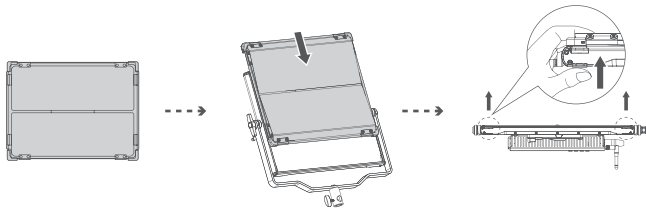

2. 拆卸：下推两侧拆装推钮，听到“咔”一声响起，即可将遮菲与柔光板顺着凹槽取出。

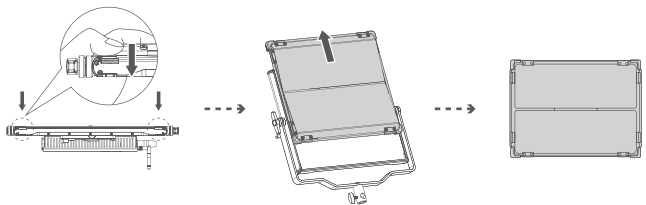

照度数据

P120Bi

色温	照度单位	1m	2m	3m	5m
3200K	lux	≈ 4260	≈ 1120	≈ 517	≈ 197
	fc	≈ 396	≈ 104	≈ 48	≈ 18
4300K	lux	≈ 4410	≈ 1170	≈ 535	≈ 205
	fc	≈ 410	≈ 108	≈ 50	≈ 19
5600K	lux	≈ 4610	≈ 1210	≈ 557	≈ 213
	fc	≈ 428	≈ 113	≈ 52	≈ 20

P120D

色温	照度单位	1m	2m	3m	5m
5600K	lux	≈ 4720	≈ 1220	≈ 559	≈ 214
	fc	≈ 438	≈ 114	≈ 52	≈ 20

维护保养

一年保修期，消耗品电池，适配器，电源线等配件不在此保修范围内。

经发现，擅自检修此 LED 板灯，将取消 LED 板灯一年保修期，维修需要收取相关费用。

对于不规范操作引起的机器故障不在保修范围内。

所有维修一概由本厂指定的可供原配件的维修部负责。

如本品出现故障或者被水淋湿，在专业人员维修后方可继续使用。该产品在工作时，如发现异常，应立即关掉电源，查明原因。

规格参数

型号	P120D	P120Bi
色温	固定 5600K	可调 3200-5600K
输入功率	120W	
CRI	平均 ≥ 97	
TLCI	平均 ≥ 98	
控制方式	DMX512 控制 / 灯体控制 / 蓝牙控制	
工作温度	-20°C ~ 45°C	
尺寸 (含 U 架)	≈459mm*417mm*70mm	
净重 (含 U 架)	≈4.5kg	

设计和规格如有变更，恕不另行通知。

Safety Instructions and Attentions

First of all, as the most basic principle: This product is a professional lighting set equipment and should be used by professional lighting engineers or under the guidance of professionals. Basic safety attentions must always be followed during use, as follows:

1. Before use, please read and understand these instructions and attentions.
2. Professional lighting is prohibited for children. When children are near, parents or accompanying persons must supervise closely to prevent children from personal injury due to collision with lamps or private use of lamps.
3. This lighting product is not ordinary lighting product and cannot be used for general lighting. Anyone who has suffered eye damage or has sensitive eyes should avoid using this product.
4. When the lamp is on, it must be used with care. Do not touch high-temperature parts, such as LED lamp beads, to avoid burns.
5. When the lamp is on, it is forbidden to look directly at the lamp beads under any circumstances. Strong light should be used under the guidance of professional lighting engineers. Avoid prolonged exposure to strong light under any circumstances. If eye discomfort, please turn off the lamp in time, suspend use, and see a doctor immediately.
6. If the lamp bead is damaged or deformed by heat, stop using this equipment, and contact the manufacturer, service agent or qualified maintenance personnel to replace the lamp bead in time to avoid accidents.
7. This product is only suitable for use in -20°C to +45°C operating environment and normal humidity environment.
8. Do not use damaged equipment or accessories, and wait for professional maintenance personnel to check and repair to confirm being normal before use.
9. During using, if the casing of this product is broken due to being dropped, squeezed or subjected to strong impact, please do not use it, so as to avoid electric shock injury due to contact with internal electronic components.
10. If an extension cord is required, please use an extension cord with a current rating greater than or equal to that of the equipment. If an extension cord is rated less than the equipment, overheating may result.
11. Some products have long power cords, please place the power cords properly and keep them in a safe place. Avoid contacting the power cord with overheating surfaces, avoid improper placement that could cause pulling damage, or trip on-site personnel. Please use the certified power cord from the original manufacturer. If the product is damaged by using a non-certified power cord, it will not be repaired by our factory.
12. Be sure to unplug equipment from the power outlet before cleaning and repairing. When

- not in use, do not pull the power cord to unplug the equipment. For normal power-off, please hold both ends of the plug of the equipment with your hands and pull the plug out of power outlet. This equipment needs to be connected to a grounded outlet.
13. This equipment is not waterproof, please keep it dry and do not immerse it in water or other liquids. The equipment should be installed in a dry and ventilated place, and avoid using it in rainy, humid, dusty or overheated environments. Do not place any objects on the lamp or let liquid flow into the lamp to avoid accidents.
 14. Do not disassemble the product without permission. If the product fails, it must be checked and repaired by authorized maintenance personnel.
 15. Before storing, make sure that the equipment has cooled down completely. For storage, unplug the power cord from the equipment. The equipment should be placed in the carrying case or in a ventilated dry place.
 16. Do not place equipment near flammable and volatile solvents such as alcohol and gasoline.
 17. Do not use accessories that are not recommended by our factory to avoid fire, electric shock or personal injury.
 18. When cleaning, do not wipe it with a damp cloth, please use a dry cloth or a soft cloth to wipe the dirt of the equipment.
 19. Please take off the protective cover before using.
 20. This product complies with ROHS, CE, and FCC certification, please refer to the relevant national standards for use and operation.
 21. The safety instructions are formulated according to the strict testing of the factory, and the design and specifications of the equipment are subject to change without prior notice. For latest product information, please check the GODOX website and view latest electronic instruction.
 22. Some products have built-in lithium batteries. Please use specified chargers, and use them within a proper range of the specified voltage and temperature according to the correct operating instructions.
 23. Some products are battery powered. Do not use any batteries, power sources or accessories not specified in the instructions for such products. Keep batteries and other accessories out of the reach of children and infants. In the instance that a child or infant swallows a battery or accessory, immediate emergency medical attention is required. If the battery leaks, becomes discolored, deformed, emits smoke, or emits an abnormal odor, remove it immediately. Be careful during removal to avoid burns. Continued use could result in fire, electric shock, or burns. Do not use any deformed or modified batteries. Do not disassemble or modify this product or battery. Do not heat or solder the battery. Keep the battery away from fire or water. Do not incorrectly insert the positive and negative ends of batteries, or mix old and new batteries or batteries of

different types together.

24. One-year warranty period, accessories such as consumable batteries, adapters, power cords, etc. are not covered by this warranty.
25. If it is found that the equipment is repaired without authorization, the one-year warranty period will be cancelled and relevant fees will be charged for maintenance.
26. Machine failures caused by non-standard operation are not covered by the warranty.

keep these instructions!

Foreword

Thank you for purchasing Godox products.

Godox is excited to introduce two new models of LED light panel, available in daylight and bi-color versions. Both versions of the LED light panel support AC power and feature a V-mount battery port. They also support Bluetooth control and DMX512 control. These lights are suitable for various applications, including news studios, virtual studios, and interview studios.

Main Features

- Stepless dimming adjustable from 0% to 100%.
- Various controlling methods: support Bluetooth control/DMX512/light body control.
- Integrated design with removable barndoor and diffuser,
- Two power supply options: supports AC power or V-mount battery power.
- P120D: Constant CCT of 5600K for crisp daylight.
- P120Bi: Adjustable CCT ranging from 3200K to 5600K for customizable warm and cool lighting.



Warning

- ⚠ Do not disassemble. Should repairs become necessary, this product must be sent to an authorized maintenance center.
- ⚠ As this product is not waterproof, do not use in rain or in damp conditions.
- ⚠ Please disconnect the power when not in use.
- ⚠ Power the lights using the AC power cord. Do not connect more than five fixtures in series.

Name of Parts

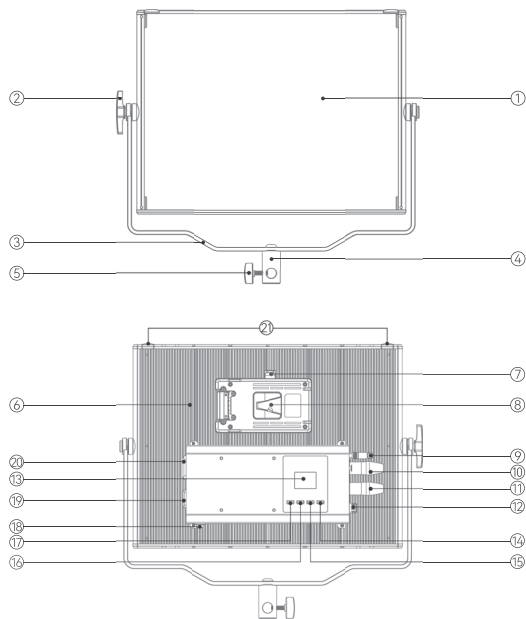

- | | | |
|-----------------------------|-------------------------|---|
| 1. Light-emitting Face | 8. V-mount Battery Slot | 15. MODE Button |
| 2. Yoke Adjust Knob | 9. Antenna Port | 16. Bluetooth Button |
| 3. Yoke | 10. DMX OUT Port | 17. INFO Button |
| 4. Sleeve | 11. DMX IN Port | 18. Power Switch |
| 5. Sleeve Knob | 12. SET Button | 19. AC INPUT Port |
| 6. Heat Dissipation Surface | 13. Display | 20. AC OUTPUT Port |
| 7. Battery Removal Button | 14. DMX Button | 21. Lock/Release Pusher
(one on the left and one on the right) |

What's Inside P120D/P120Bi

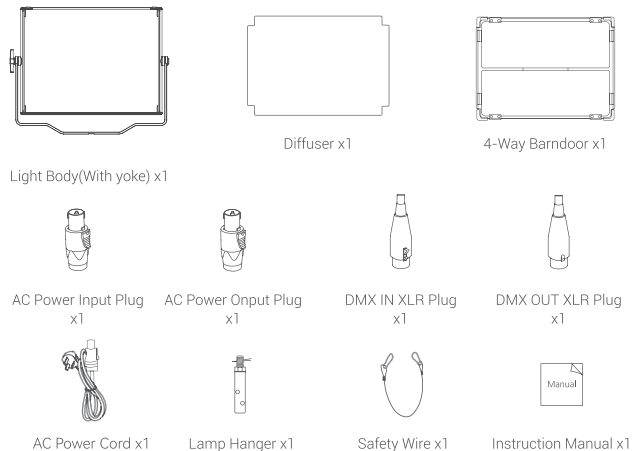

What's Inside P120D K1/P120Bi K1



What's Inside P120D K2/P120Bi K2

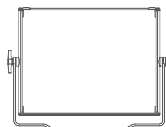

Light Body (With yoke) x3



Diffuser x3



4-Way Barndoor x3



AC Power Cord
x3

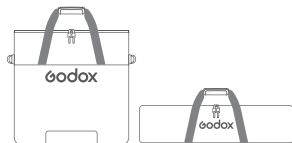

Carry Bag 1+1



Safety Wire x3



Bracket 304 x3



Instruction
Manual x1

Optional Accessories

Honeycomb Gh50-P120

Power Supply

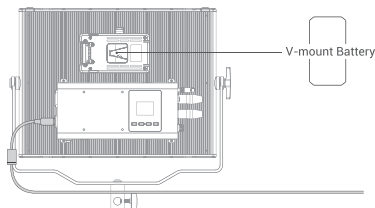

1. V-mount Battery Power Supply

The light can be powered by inserting a 14.8V V-mount battery.

Note: V-mount battery needs to be purchased separately.

2. AC Power Supply

100V-240V ~ 50/60Hz

Power Switch

1. After inserting a V-mount battery, toggle the power switch to the <-> icon to turn on the device.
2. When connected to the power source using the AC power cord, toggle the power switch to the < o > icon to turn on the device.
3. Regardless of the power supply mode, toggle the power switch to the < = > icon to turn off the device.



Operating instructions

1. DMX Setup

Press the DMX button briefly to enter the DMX setup interface. Rotate the SET Knob to select the DMX address (1-512).

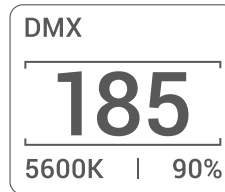

DMX Connection

Note: Only DMX connection method is shown, DMX converter cable and DMX512 controller need to be purchased separately.

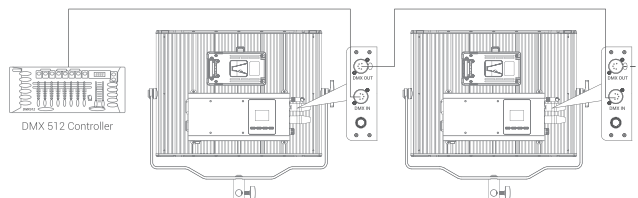

DMX Practical Table

Mode	Channel	Function	DMX Value	Parameter
CCT 8bit	1	Brightness	0 – 255	0% – 100%
	2	CCT	0 – 255	3200K – 5600K

Note:Color temperature adjustment is only available on P120Bi Bi-color version.

2. Brightness/Color Temperature Settings

For the P120D single-color temperature version:

Press the MODE button briefly to enter the brightness setting interface. Rotate the SET knob to adjust the brightness level within the range of 0% to 100% or 0-255, switch between different brightness values by briefly pressing the MODE button. The single-color temperature version has a fixed color temperature of 5600K and does not support color temperature adjustment.

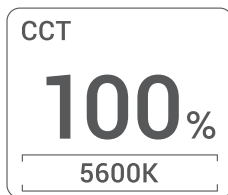

For the P120Bi dual-color temperature version:
Press the MODE button briefly to enter the brightness/color temperature setting interface. Rotate the SET knob to adjust the brightness level within the range of 0% to 100% or 0-255, switch between different brightness values by briefly pressing the MODE button. After completing the brightness adjustment, press the SET button briefly to enter the color temperature adjustment menu. Rotate the SET knob to adjust the color temperature within the range of 3200K to 5600K.

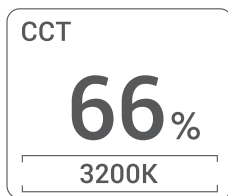

3. Bluetooth Setup

Press the Bluetooth button briefly to enter the Bluetooth setup interface. Rotate the SET knob to select Bluetooth on or off. After completing the setting, press the SET button briefly to move to the next option, which includes Bluetooth reset or cancel. The MAC code is located at the bottom of the interface for easy identification and pairing of the device.

Downloading "Godox Light"App

Scan the QR code below to download the "Godox Light" app (compatible with both Android and iOS systems).

Note: 1.The first mobile device (phone or tablet) can directly control the light body using the app. When switching to another mobile device, the light body needs to be Bluetooth reset before the app can be used.
2.The app needs to be upgraded to version 3.0 or above.

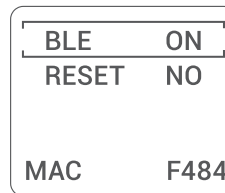

4. Fixture Info

Press the INFO button briefly to enter fixture info setting interface to check firmware version number.



Installation/Removal of Barndoor and Diffuser

Installation: Slide the Barndoor and Diffuser parallel into the installation groove, push up the lock/release pusher, once you hear a "click" sound, it is installed successfully.

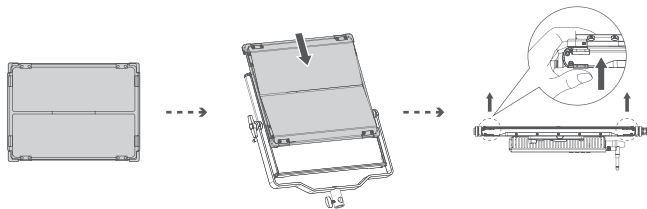

Removal: Push down the lock/release pusher, once you hear a "click" sound, you can then remove the Barndoor and Diffuser by sliding it out along the groove.

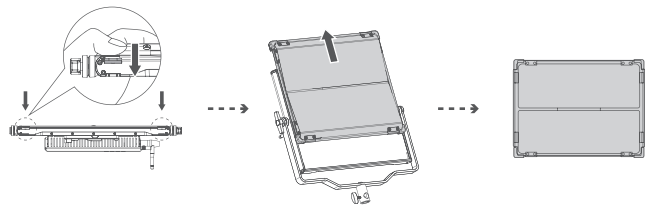

Photometric Data

P120Bi

CCT	Unit	1m	2m	3m	5m
3200K	lux	≈4260	≈1120	≈517	≈197
	fc	≈396	≈104	≈48	≈18
4300K	lux	≈4410	≈1170	≈535	≈205
	fc	≈410	≈108	≈50	≈19
5600K	lux	≈4610	≈1210	≈557	≈213
	fc	≈428	≈113	≈52	≈20

P120D

CCT	Unit	1m	2m	3m	5m
5600K	lux	≈4720	≈1220	≈559	≈214
	fc	≈438	≈114	≈52	≈20

Maintenance

This product, except consumables, is supported with a one-year warranty.

Unauthorized service will void the warranty.

Maintenance of the light must be performed by our authorized maintenance department which can provide original accessories.

If the product had failures or got wet, do not use it until it is repaired by professionals.

Shut down the device immediately should abnormal operation be detected.

Technical Data

Model	P120D	P120Bi
CCT	Constant 5600K	Adjustable 3200-5600K
Max. Power	120W	
CRI	Average:97	
TLCI	Average:98	
Controlling Methods	DMX512 Control/Light Body Control/Bluetooth Control	
Working Environment Temperature	-20°C 45°C	
Dimension (yoke included)	≈18.07"x16.42"x2.76"	
Net Weight (yoke included)	≈4.5kg	

Specifications and data may subject to changes without notice.

FCC Statement

This device complies with part 15 of the FCC Rules. Operation is subject to the following two conditions:

- (1) This device may not cause harmful interference, and
- (2) this device must accept any interference received, including interference that may cause undesired operation.

Any Changes or modifications not expressly approved by the party responsible for compliance could void the user's authority to operate the equipment.

Note: This equipment has been tested and found to comply with the limits for a Class B digital device, pursuant to part 15 of the FCC Rules. These limits are designed to provide reasonable protection against harmful interference in a residential installation. This equipment generates uses and can radiate radio frequency energy and, if not installed and used in accordance with the instructions, may cause harmful interference to radio communications. However, there is no guarantee that interference will not occur in a particular installation. If this equipment does cause harmful interference to radio or television reception, which can be determined by turning the equipment off and on, the user is encouraged to try to correct the interference by one or more of the following measures:

- Reorient or relocate the receiving antenna.
- Increase the separation between the equipment and receiver.
- Connect the equipment into an outlet on a circuit different from that to which the receiver is connected.
- Consult the dealer or an experienced radio/TV technician for help.

The device has been evaluated to meet general RF exposure requirement.

The device can be used in portable exposure condition without restriction.

Warning

Operating frequency: 2402MHz – 2480MHz (BT)

Maximum EIRP Power : 9.09dBm

Declaration of Conformity

GODOX Photo Equipment Co.,Ltd. hereby declares that this equipment are in compliance with the essential requirements and other relevant provisions of Directive 2014/53/EU. In accordance with Article 10(2) and Article 10(10), this product is allowed to be used in all EU member states.

For more information of DoC, Please click this web link:

<https://www.godox.com/eu-declaration-of-conformity/>

The device complies with RF specifications when the device used at 0mm from your body.

产品保修

尊敬的用户, 本保修卡是申请保修服务的重要凭证, 请您配合销售商填写并妥善保管, 谢谢!

产品信息	型号	产品条码
用户信息	姓名	联系电话
	通信地址	
销售商信息	名称	
	联系电话	
	通信地址	
	销售日期	
备注		

注: 此表应由销售商盖章确认。

适用产品

本文件适用于相关《产品保修资讯》(见后面说明)所列产品。其他非属此范围的产品或部件(如促销品、赠品及其他出厂后附加的部件等)不在此保修承诺内。

保修期

产品及部件的相应保修期按相关的产品保修信息执行。保修期自产品首次购买日起算, 购买日以购买产品时保修卡登记日期为准。

如何获得保修服务

您可直接与产品销售商或授权服务机构联系, 也可拨打神牛产品售后服务电话, 与我们联系, 由我们的服务人员为您安排服务。申请保修时, 您应提供有效的保修卡作为保修凭证, 方可获得保修。如您不能提供有效的保修卡, 则在我们确认产品或部件属于保修范围的情况下, 也可以为您提供保修, 但这不作为我们的义务。

不适用保修情况

如产品存在下列情况, 本文件项下的保证和服务将不适用: ①产品或部件超过相应保修期; ②错误或不当使用、维护或保管导致的故障或损坏, 如: 不当搬运; 非按产品合理预期用途使用; 不当插拔外接设备; 跌落或外力挤压; 接触或暴露于不当温度、溶剂、酸碱、水浸或潮湿环境; ③由非神牛授权机构或人员安装、修理、更改、添加或拆卸造成的故障或损坏; ④产品或部件原有识别信息被修改变更或删除; ⑤无有效保修卡; ⑥使用非合法授权、非标准或非公开发行的软件造成的故障或损坏; ⑦因不可抗力或意外事件造成的故障或损坏; ⑧其他非因产品本身质量问题导致的故障或损坏。遇上述情况, 您应向相关责任方寻求解决, 神牛对此不承担任何责任。因非在保修期或保修范围内的部件、附件或软件导致产品不能正常使用的, 不是保修范围内的故障。产品使用过程中正常的脱色, 磨损和消耗, 不是保修范围内的故障。

产品保修和服务支持信息

产品的保修期和服务类型按以下《产品保修信息》执行:

产品类别	选件名称	保修期(月)	保修服务类型
部件	主机	12	客户送修
	电池	3	客户送修
	充电器等带电性能的部件。	12	客户送修
其他	如电源线、同步线、外壳、保护罩、锁紧装置、包装等。	无	无保修

神牛产品售后服务电话: 0755-29609320-8062

Warranty

Dear customers, as this warranty card is an important certificate to apply for our maintenance service, please fill in the following form in coordination with the seller and safe-keep it. Thank you!

Product Information	Model	Product Code Number
Customer Information	Name	Contact Number
	Address	
Seller Information	Name	
	Contact Number	
	Address	
	Date of Sale	
Note:		

Note: This form shall be sealed by the seller.

Applicable Products

The document applies to the products listed on the Product Maintenance Information (see below for further information). Other products or accessories (e.g. promotional items, giveaways and additional accessories attached, etc.) are not included in this warranty scope.

Warranty Period

The warranty period of products and accessories is implemented according to the relevant Product Maintenance Information. The warranty period is calculated from the day(purchase date) when the product is bought for the first time, And the purchase date is considered as the date registered on the warranty card when buying the product.

How to Get the Maintenance Service

If maintenance service is needed, you can directly contact the product distributor or authorized service institutions. You can also contact the Godox after-sale service call and we will offer you service. When applying for maintenance service, you should provide valid warranty card. If you cannot provide valid warranty card, we may offer you maintenance service once confirmed that the product or accessory is involved in the maintenance scope, but that shall not be considered as our obligation.

Inapplicable Cases

The guarantee and service offered by this document are not applicable in the following cases: ① . The product or accessory has expired its warranty period; ② . Breakage or damage caused by inappropriate usage, maintenance or preservation, such as improper packing, improper usage, improper plugging in/out external equipment, falling off or squeezing by external force, contacting or exposing to the improper temperature, solvent, acid, base, flooding and damp environments, etc; ③ . Breakage or damage caused by non-authorized institution or staff in the process of installation, maintenance, alternation, addition and detachment; ④ . The original identifying information of product or accessory is modified, alternated, or removed; ⑤ . No valid warranty card; ⑥ . Breakage or damage caused by using illegally authorized, nonstandard or non-public released software; ⑦ . Breakage or damage caused by force majeure or accident; ⑧ . Breakage or damage that could not be attributed to the product itself. Once met these situations above, you should seek solutions from the related responsible parties and Godox assumes no responsibility. The damage caused by parts, accessories and software that beyond the warranty period or scope is not included in our maintenance scope. The normal discoloration, abrasion and consumption are not the breakage within the maintenance scope.

Maintenance and Service Support Information

The warranty period and service types of products are implemented according to the following Product Maintenance Information:

Product Type	Name	Maintenance Period(month)	Warranty Service Type
Parts	Circuit board	12	Customer sends the product to designated site
	Battery	3	Customer sends the product to designated site
	Electrical parts e.g.battery charger, etc.	12	Customer sends the product to designated site
Other Items	Lamp body, lamp cover, locking device, package, etc.	NO	Without warranty

Godox After-sale Service Call 0755-29609320-8062