

Ver:EN2ND20241204601 601-415

Godox

KNOWLED CINEMATIC LIGHTING ECOSYSTEM

Godox

GODOX Photo Equipment Co.,Ltd.

Factory Add: 4th Floor of Building 1, 1st to 4th Floor of Building 2, 4th Floor of Building 3, 1st to 4th Floor of Building 4, Yaochuan Industrial Zone, Tangwei Community, Fuhai Street, Bao'an District, Shenzhen 518103, China

TEL: +86-(0)755-25701197,25726373

FAX: +86-(0)755-25723423

Email: godox@godox.com

www.godox.com



Knowled Global



Knowled Global



knowled_global



Knowled Global

2024 | 2nd EDITION



Knowledge Take You Further

At Godox, we have always been dedicated to providing a comprehensive range of lighting solutions for filmmakers and content creators. KNOWLED series, in particular, stands as a testament to our commitment to elevating the standards of professional production.

In the dynamic world of film and television production, lighting plays a pivotal role in shaping narratives, evoking emotions, and capturing moments in their full splendor. With KNOWLED cinematic lighting ecosystem, we empower filmmakers with the tools they need to bring their creative visions to life.



CONTENTS

05 • COB Light

MG2400Bi
MG1200R
MG1200Bi
M600R
M600Bi Pro/M600Bi
M200D/M200Bi/M300D/M300Bi

35 • Focusing Light

S60/S60Bi

41 • Panel Light

P600Bi Hard
P600R Hard/P1200R Hard
P300R/P600R

55 • Flexible LED Mat

F100R/F200R/F200SR/F400R/F800R
F200Bi/F400Bi/F600Bi

67 • Tube Light

TP2R/TP4R/TP8R

73 • Air Tube Light

AT200Bi

77 • Ambient Light

C5R/C7R/C10R

83 • Cine Lighting Reflector

LiteFlow 7/15/25/50/100

91 • Control System

KNOWLED APP

93 • Accessory

BeamLight Max90
BeamLight B60/Max60
Projection Attachment GP19K/26K/36K
Projection Attachment VSA-19K/26K/36K
DL5 Parallel Booster
Fresnel Lens GF14/FLS8/FLS10
Scrim Flag SF6090/SF4560 Kit
Parabolic Softbox QR-P70/P90/P120
Softbox Series SB Series
Lighting Stands



KNOWLED COB LIGHTS



SPECS

Model	MG2400Bi	MG1200R	MG1200Bi
Luminance(with reflector)	4,650lux with GR45 @10m(5600K)	118000Lux with GR15 @3m(5600K)	149,000Lux with GR15 @3m(5600K)
Color Version	Bi-color	Full-color	Bi-color
CCT	2800K-6500K	1800-10000K	2800K-6500K
Max. Power	2600W	1600W	1400W
Color Rendering	CQS≥95/CRI≥96/TLCl≥96	CRI≥96/TLCl≥95	CQS≥94/CRI≥96/TLCl≥96/ R15≥92/TM-30 RF≥92
Controls	CRMX/Ethernet/DMX/ Removable panel/App/ On-board	CRMX/Ethernet/DMX/ Removable panel/APP/On-board	CRMX/Ethernet/DMX/ Removable panel/App/ On-board/Remoter
Power Supply	AC	AC	AC
Dimension			
Light Body	409*385*356mm	400*589*339mm	378*579*354mm
Controller	280*420*210mm	189*174*404mm	162*190*372mm
Weight			
Light Body	22kg	9.8kg	16kg
Controller	13kg	6.7kg	6.68kg



SPECS

Model	M600R	M600Bi Pro	M600Bi	M200D/Bi/M300D/Bi
Luminance(with reflector)	136,000Lux with BR45 @1m(5600K)	18800Lux with BR60 @3m(5600K)	17,500Lux @3m(5600K)	M200D: 8,850Lux/M200Bi: 9,440Lux M300D: 8,980Lux/M300Bi: 12,900Lux @3m(5600K)
Color Version	Full-color	Bi-color	Daylight/Bi-color	Daylight/Bi-color
CCT	1800K-10000K	2800K-6500K	2800K-6500K	D: 5600K/Bi: 2800K-6500K
Max. Power	720W	650W	730W	230W/230W/330W/360W
Color Rendering	CQS≥95/CRI≥96/TLCl≥96	CRI≥97/TLCl≥98	CRI≥96/TLCl≥97	CRI≥96/TLCl≥97
Controls	CRMX/Ethernet/DMX/ App/On-board	DMX/LumenRadio CRMX/Etherne/Art-Net&sACN protocol/ Bluetooth app/remove controller control (controller is sold separately)	DMX/On-board/App/Remoter	DMX/On-board/App/Remoter
Power Supply	AC	AC	AC/DC 48V/V-mount battery	AC/DC 48V/V-mount battery
Dimension				
Light Body	317*501*347mm	174*298*177mm	481.3*242.8*152.9mm	425.3*232.3*141.7mm
Controller	189*166*334mm	189*166*334mm	332.4*121.6*179.2mm	270.4*123.6*132mm
Weight				
Light Body	10kg	4.6kg	4.96kg	3.03kg/3.2kg/3.3kg/3.5kg
Controller	6kg	5.5kg	3.74kg	2.74kg/2.7kg/2.74kg/2.7kg

Bi-color LED Light | MG2400Bi

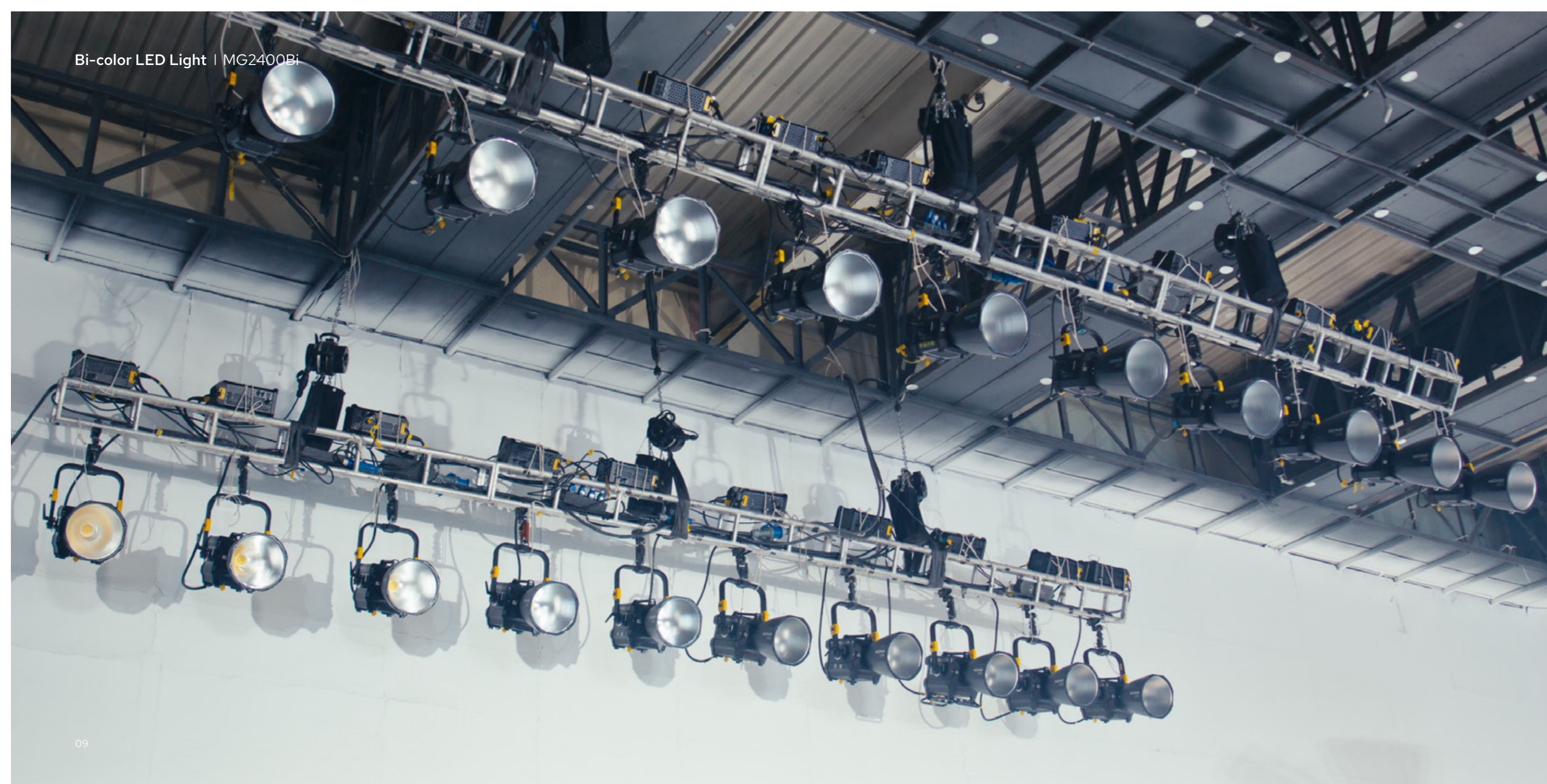

Bi-color LED Light | MG2400Bi



POWER
2600w

Power 2600W

IP54

Weather Resistance



2800K-6500K



G-Mount



4,410lux@10m
with 45° Reflector

MG2400Bi

- CCT: 2800-6500K
- 2600W power across all color temperatures
- CQS≥95, CRI≥96, TLCI≥96
- Controls: DMX & RDM, LumenRadio CRMX, Ethernet (sACN and ArtNet protocol), App control, on-board and removable panel
- Compatible with Godox G-Mount with a complete light shaping system
- IP54 weather resistance
- 0.1% stepless adjustment
- High efficient heat dissipation system
- 4 dimming curves
- 11 built-in FX effects
- 360° rotatable U-Type yoke
- 8-meters power cord and connecting cord

Bi-color LED Light | MG2400Bi



MG2400Bi

Light Body	×1	Protection Cover	×1
Yoke	×1	Safety Wire	×1
Controller	×1	Main Cable	×1
Antenna	×1	DC Cable	×1
Reflector	×1	Tying Rope	×1
Clamp	×1		



MG2400Bi K1 Kit

Light Body	×1	Safety Wire	×1
Yoke	×1	Main Cable	×1
Controller	×1	DC Cable	×1
Antenna	×1	Tying Rope	×1
Reflector	×1	Soft Case for Light Body SC18	×1
Clamp	×1	Soft Case for Accessory SC19	×1
Protection Cover	×1		



MG2400Bi K2 Kit

Light Body	×1	Protection Cover	×1
Yoke	×1	Safety Wire	×1
Controller	×1	Main Cable	×1
Antenna	×1	DC Cable	×1
Reflector	×1	Tying Rope	×1
Clamp	×1	Flight Case FC05	×1

Bi-color LED Light | MG2400Bi





POWER
1500w
High Output

Full Color



Lightweight Design

G-Mount Accessories

MG1200R

- Full-Color Lighting 1800K-10000K range for versatile effects.
- 1500W power with vivid color saturation.
- HSI, RGBW, GEL, X-Y, CCT, FX for creative use.
- Seamless Integration with Entire Setup.
- Only 9.8kg for easy handling.
- 0.1% precision for low-light adjustments.
- Flicker-Free at High Speeds.
- DMX, CRMX, Ethernet, Bluetooth with app integration.
- Leading Accessory Ecosystem.

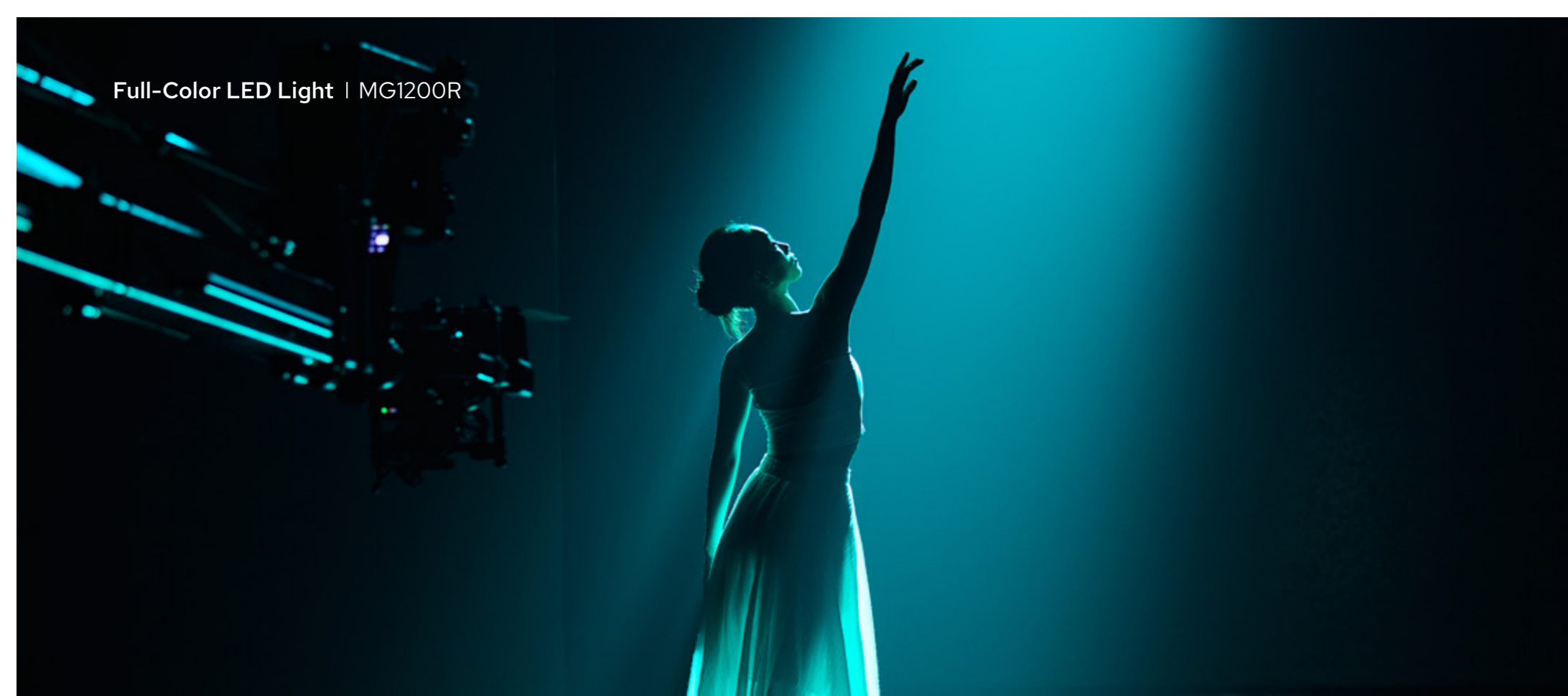
Full-Color LED Light | MG1200R



Exceptional Lighting Performance



Full-color Stage shooting



Built for Easy Handling

Full-Color LED Light | MG1200R



MG1200R

Light Head	x1	Super Clamp	x1
Controller	x1	Tying Rope	x1
Protective Cover	x1	Safety Rope	x1
U-Bracket	x1	DC PowerCord	x1
GR45 Reflector	x1	AC Power Cord	x1



MG1200R K1

Light Head	x1	Tying Rope	x1
Controller	x1	Safety Rope	x1
Protective Cover	x1	DC Power Cord	x1
U-Bracket	x1	AC Power Cord	x1
GR45 Reflector	x1	Carrying Case	x1
Super Clamp	x1		



MG1200R K2

Light Head	x1	Tying Rope	x1
Controller	x1	Safety Rope	x1
Protective Cover	x1	DC Power Cord	x1
U-Bracket	x1	AC PowerCord	x1
GR45 Reflector	x1	Protective Wheeled Case	x1
Super Clamp	x1		



MG1200R K3

Light Head	x1	Tying Rope	x1
Controller	x1	Safety Rope	x1
Protective Cover	x1	DC Power Cord	x1
U-Bracket	x1	AC Power Cord	x1
GR45 Reflector	x1	Flight Case	x1
Super Clamp	x1		

Bi-color LED Light | MG1200Bi



Bi-color LED Light | MG1200Bi



POWER
1200w
Power 1200W

IP54
Weather Resistance

2800K-6500K

G-Mount

86,100lux@3m
with Fresnel

MG1200Bi

- CCT: 2800-6500K
- 1200W power across all color temperatures
- CQS≥94, CRI≥96, TLCI≥96, R15≥92, TM-30 Rf≥92
- Controls: DMX & RDM, LumenRadio CRMX, Ethernet (sACN and ArtNet protocol), App control, 2.4GHz remote, on-board and removable panel
- Compatible with Godox G-Mount with a complete light shaping system
- IP54 weather resistance
- 0.1% stepless adjustment
- High efficient heat dissipation system
- 4 dimming curves
- 11 built-in FX effects
- 360° rotatable U-Type yoke
- 8-meters power cord and connecting cord

Bi-color LED Light | MG1200Bi



Bi-color LED Light | MG1200Bi



MG1200Bi

Light Body	×1	Power Cable	×1
U-type Bracket	×1	Carry Bag	×1
Controller	×1	Controller Mounting Device PC01	×1
Antenna	×1	Light Protection Cover	×1
Steel Rope	×1	DC Connect Cable	×1
Reflector GR45	×1		



MG1200Bi K1 (3 reflectors included)

U-type Bracket	×1	DC Connect Cable	×1
Controller	×1	30° Reflector GR30	×1
Antenna	×1	45° Reflector GR45	×1
Steel Rope	×1	60° Reflector GR60	×1
Power Cable	×1	Soft Case SC01	×1
Controller Mounting Device PC01	×1	Reflector Case 1	×1
Light Protection Cover	×1		



MG1200Bi K2 (4 reflectors included)

Light Body	×1	DC Connect Cable	×1
U-type Bracket	×1	15° Reflector GR15	×1
Controller	×1	30° Reflector GR30	×1
Antenna	×1	45° Reflector GR45	×1
Steel Rope	×1	60° Reflector GR60	×1
Power Cable	×1	Soft Case SC01	×1
Controller Mounting Device PC01	×1	Reflector Case 2	×1
Light Protection Cover	×1		



MG1200Bi K3 (4 reflectors & hard case included)

Light Body	×1	DC Connect Cable	×1
U-type Bracket	×1	15° Reflector GR15	×1
Controller	×1	30° Reflector GR30	×1
Antenna	×1	45° Reflector GR45	×1
Steel Rope	×1	60° Reflector GR60	×1
Power Cable	×1	Hard Case HC01	×1
Controller Mounting Device PC01	×1	Reflector Case 2	×1
Light Protection Cover	×1		



Night-for-day lighting



Studio set lighting



Sunlight-through-windows simulation

Optional Purchase (for MG1200Bi & MG2400Bi)



Max90
BeamLight Max90



GP26K
Projection Attachment
With 26° Lens



GP-Lens 19° (optional)



GP-Lens 36° (optional)



GF14
Fresnel Lens



GF14B
Barndoor for Fresnel Lens



SC06
Soft Case for Fresnel



GR15
15° Reflector



GR30
30° Reflector



GR45
45° Reflector



GR60
60° Reflector



RC-A6II
2.4GHz Remoter
(for MG1200Bi)



RC-R9II
2.4GHz Remoter
(for MG1200Bi)



RC11
Removable
Controller



GL3/GL4
Lantern Softboxes



GP3/GP4/GP5
Parabolic Softboxes



GS33/GS34/GS44
Rectangular Softboxes



GO4
Octa Softboxes



SC01
Soft Case (for MG1200Bi)



HC01
Hard Case (for MG1200Bi)



Yoke G2400BY01
(for MG2400Bi)

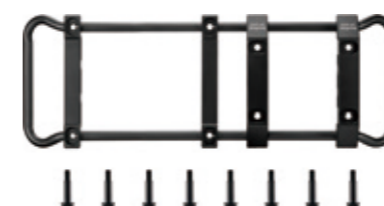

GP-SKID
Skid for GP (for MG2400Bi)



SC18
Soft Case for Light Body
(for MG2400Bi)



SC19
Soft Case for Accessory
(for MG2400Bi)



FC05
Flight Case
(for MG2400Bi)



GP-QB
Quick-Lock Bracket (for MG2400Bi)

Comprehensive Light-Shaping System

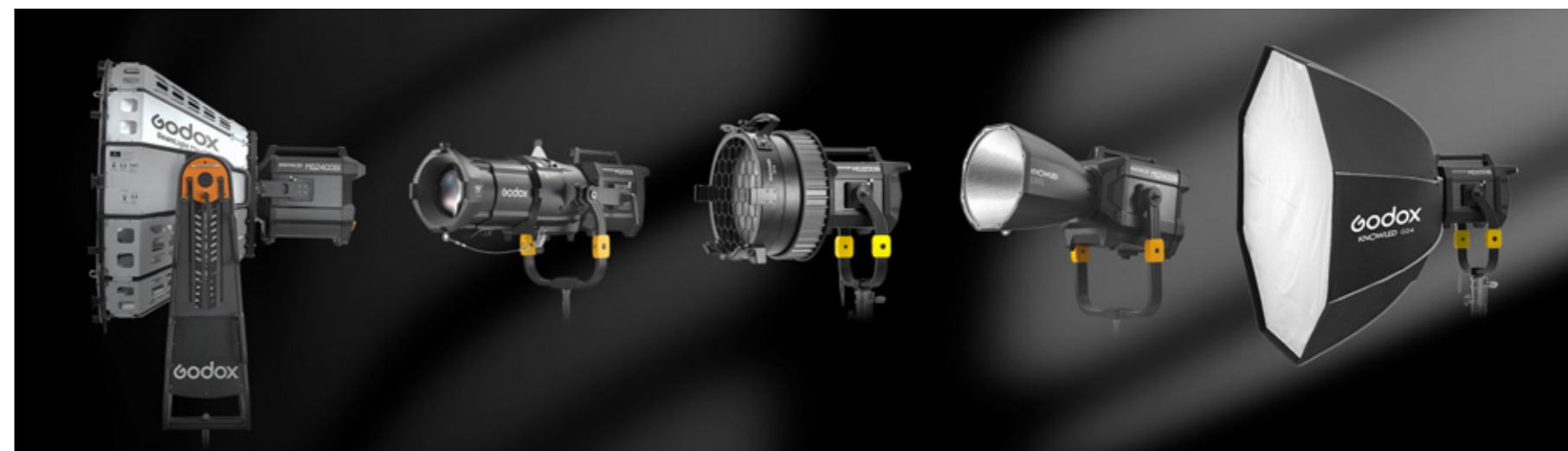

Full-color LED Light



Full-color LED Light | M600R



Ultra-BrightColors

IP54

Weather-Resistance



DMX/CRMX



Godox KNOWLED App

M600R

- Full-color capability
- CCT: 1800K-10000K
- Color light brightness greatly surpassing similar lights at equal power
- 136,000 lux with Reflector BR45 at 1 meter
- Innovative optical design for high-quality output, reduced heat, and longer lifespan
- IP54 weather-resistance
- CQS≥95, CRI≥96, TLCI≥96
- Flicker-free performance
- Extreme temperature performance even under -20°C
- Controls: DMX, CRMX, Ethernet (sACN and ArtNet protocol), Bluetooth app control, on-board
- Bowens Mount

Full-color LED Light



5600K: 136000Lux
R: 25100Lux G: 33700Lux B: 10600Lux
@1m(with Reflector BR45)

Full-color LED Light | M600R



What's in the Box



- Light Body x1
- Reflector Br45 x1
- AC Power Cord x1
- Safety Wire x1
- Controller x1
- Tying Rope x1

Optional Purchase

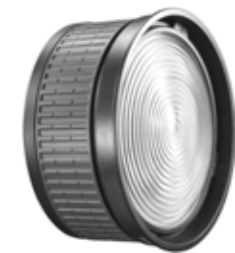

Fresnel BF10

- Yoke x1
- Light Protection Cover x1
- DC Cable x1
- Pipe Clamp x1
- Soft Case SC20 x1



POWER
600w
600W output

IP54
Full Protection

2800K-6500K

CRMX/DMX/
Ethernet/Bluetooth

M600Bi Pro

- CCT: 2800K - 6500K
- IP54 weather resistance
- Smoother, more linear dimming
- Pairs seamlessly with the B60 for parallel beams
- Controls: DMX, CRMX, Ethernet, Bluetooth, and on-board control
- exceptional durability and reliability
- Precise 0.1% dimming control
- 11 Build-in FX effects
- CRI of 97 and TLCI of 98
- Bowens mount for wide compatibility



POWER
730w
Power 730W

Supporting V-mount
Battery



15,700Lux@3m
with Reflector

Bowens Mount

M600Bi

- CCT: 2800K-6500K
- 17,500 lux (with reflector)/40,100lux (with Fresnel) at 9.8'
- Well-engineered to evenly blend the colors
- Top-notch control box
- CRI≥96, TLCI≥97
- Adjustable finely in 0.1% or quickly in 10% increments
- 4 dimming curves
- Supporting V-mount battery power supply
- Powerful cooling system
- Controls: DMX, App control, 2.4GHz remote, on-board
- 7 built-in FX effects
- Bowens mount for wide compatibility

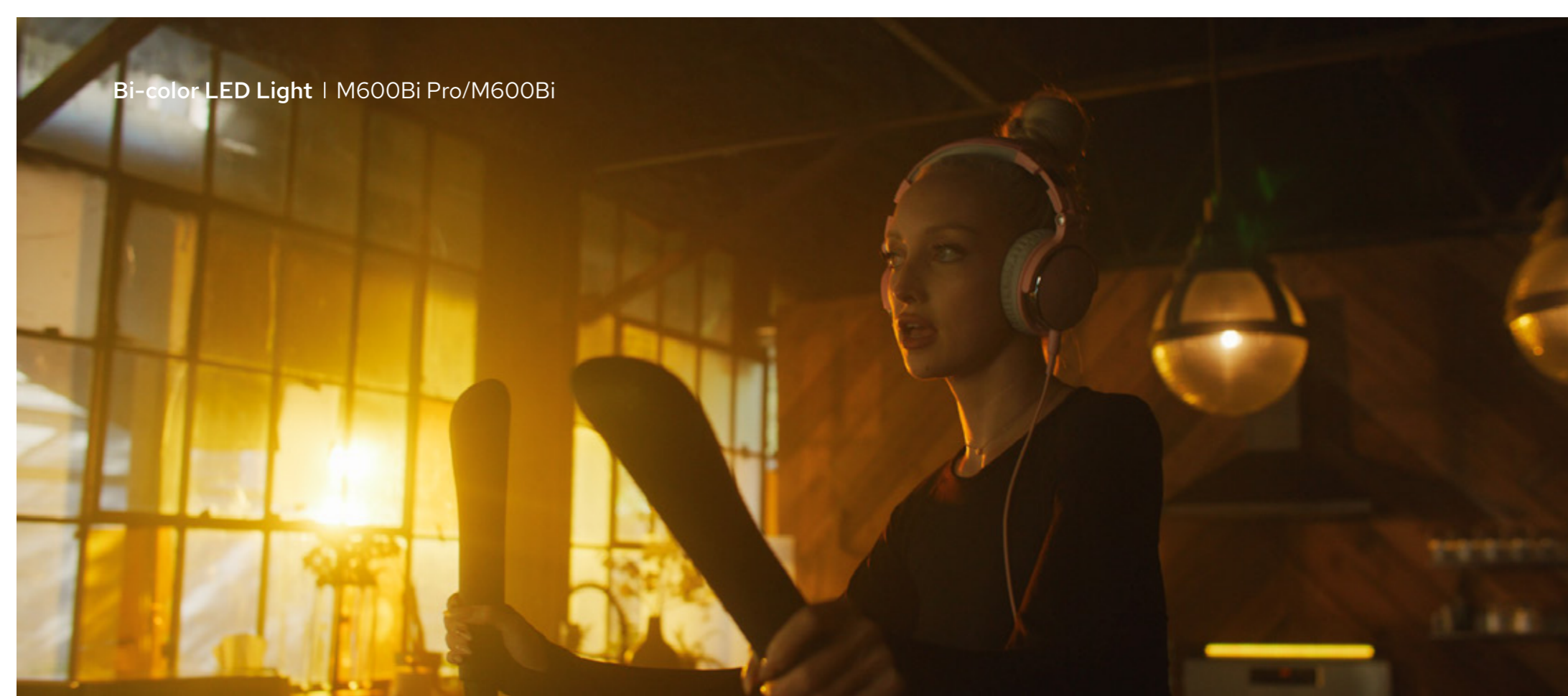
Bi-color LED Light | M600Bi Pro/M600Bi



Bi-color LED Light | M600Bi Pro/M600Bi



M600Bi Pro

Light Body	x1	Tying Rope	x1
Controller	x1	Safety Rope	x1
Protection Cover	x1	DC Power Cord	x1
U-type Bracket	x1	AC PowerCord	x1
Reflector BR30	x1	Controller Mounting Device	x1

M600Bi Pro K1

Light Body	x1	Storage Bag	x1
Controller	x1	Safety Rope	x1
Protection Cover	x1	DC Power Cord	x1
U-type Bracket	x1	AC PowerCord	x1
Reflector Br30	x1	Controller Mounting Device	x1
Tying Rope	x1		

M600Bi

Light Body	x1	Connecting Cord	x1
Controller	x1	5m Power Cord	x1
Portable Case	x1	Connecting Cord Fixed Rope	x1
Lamp Cover	x1	Standard Reflector RFT-19	x1
Controller Clamp (LSA-19&LSA-03)	x1		



Sunset simulation



On-location night scene



Commercial lighting



CRI
96+
CRI≥96

TLCI
97+
TLCI≥97

CCT(M200Bi & M300Bi)
2800K-6500K

Supporting V-mount
Battery

Bowens Mount

M200D/M200Bi/M300D/M300Bi

- Providing the highest value of a 200W or 300W LED light
- CCT (M200Bi & M300Bi): 2800K-6500K
- All-in-one control box
- CRI≥96, TLCI≥97
- 4 dimming curves
- Supporting V-mount battery power supply
- Powerful cooling system
- Controls: DMX, App control, 2.4GHz remote, on-board
- Built-in FX effects
- Bowens mount for wide compatibility

Daylight/Bi-color LED Light | M200D/200Bi/300D/300Bi



Daylight/Bi-color LED Light | M200D/200Bi/300D/300Bi



M200D

Light Body	×1	Carry Bag CB49	×1
Connecting Cable	×1	Controller Clamp(LSA-19&LSA-03)	×1
5m Power Cable	×1	Bowens Mount Pro Reflector RFT-19	×1
Fixed Rope	×1	Controller	×1
Lamp Cover	×1		



M300D

Light Body	×1	Carry Bag CB49	×1
Connecting Cable	×1	Controller Clamp(LSA-19&LSA-03)	×1
5m Power Cable	×1	Bowens Mount Pro Reflector RFT-19	×1
Fixed Rope	×1	Controller	×1
Lamp Cover	×1		



M200Bi

Light Body	×1	Carry Bag CB49	×1
Connecting Cable	×1	Controller Clamp(LSA-19&LSA-03)	×1
5m Power Cable	×1	Bowens Mount Pro Reflector RFT-19	×1
Fixed Rope	×1	Controller	×1
Lamp Cover	×1		



M300Bi

Light Body	×1	Carry Bag CB49	×1
Connecting Cable	×1	Controller Clamp(LSA-19&LSA-03)	×1
5m Power Cable	×1	Bowens Mount Pro Reflector RFT-19	×1
Fixed Rope	×1	Controller	×1
Lamp Cover	×1		



Outdoor lighting

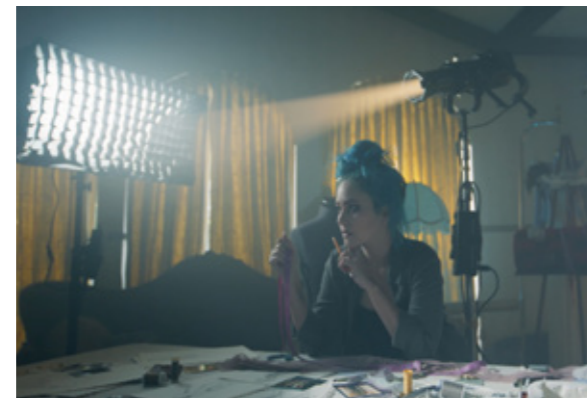

Interior lighting



Daylight simulation



FOCUSING LIGHTS



SPECS

Model	S60	S60Bi
Power Supply	AC Power Supply: 100~240V 50/60HZ 0.9A MAX V-port battery: Standard voltage: 14.8V (optional)	AC Power Supply: 100~240V 50/60HZ 0.9A MAX V-port battery: Standard voltage: 14.8V (optional)
Output Power	60W	77W
CCT	5600K±300K	2800K±6500K
100% Illuminance(LUX)(1m,darkroom)(≈)	Spot (Central Area): 3200 Flood (Central Area): 40000	Spot (Central Area): 3200 Flood (Central Area): 40000
CRI/TLCI	≥96/≥97	≥96/≥97
Brightness Range	0~100%	0~100%
Channel(CH)	32 (1 to 32)	32 (1 to 32)
Group (GR)	16 (A to F/O to 9)	16 (A to F/O to 9)
Beam Angle	6°-55°	6°-55°
Working Environment Temperature	-10~40°C	-10~40°C
Control Method	Smartphone APP/2.4G wireless remote control/DMX control	Smartphone APP/2.4G wireless remote control/DMX control
2.4G Wireless Transmission Distance(≈)	50m	50m
Dimension	Light Body: 264*107*100mm/Controller: 268*113*64mm	Light Body: 264*107*100mm/Controller: 233*112*61mm
Weight	Light Body: 1.36kg/Controller: 0.94kg	Light Body: 1.36kg/Controller: 1kg



Beam Angle 6°-55°



2800-6500K(Bi)

CRI 96+

CRI≥96

TLCI 97+

TLCI≥97



Silent mode

S60/S60Bi

- Beam angle from 6 to 55 degrees, light where you want
- Variable Color Temperature
- CRI≥96, TLCI≥97
- Lighting FX
- Silent mode
- Controls: Godox Light app, remoter, and DMX

Focusing Lights | S60/S60Bi



S60/S60Bi

Light Head	x1	Wrench	x1
Controller Box	x1	Connect Cable	x1
SA-08 Barndoor Set	x1	Power Cable	x1

Focusing Lights | S60/S60Bi

Projection attachment: project a highly focused and controlled beam of light. This attachment is what enables you to get the utmost out of creativity of Focusing light series for it is specially designed for fitting a vast range of light shaping accessories.



Abundant Accessories

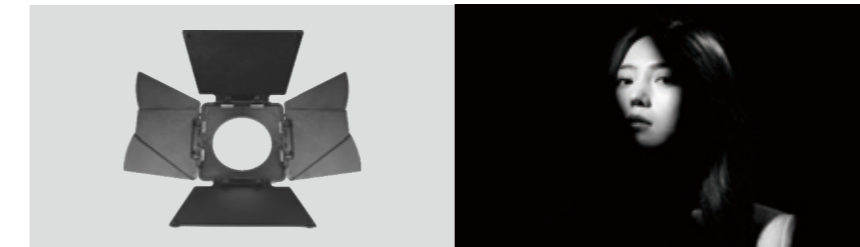

SA-08 Barndoor Set

Barndoor set: to precisely control the light beam as required. There are small clips on the plate for clipping diffusion fabric or gels on.

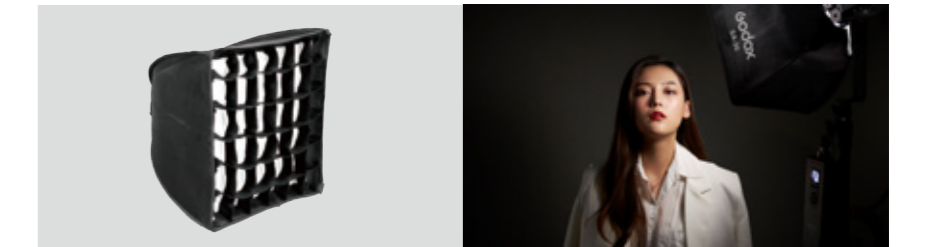

SA-30/SA-20 Softbox

Offers soft and even light effects.



Simulating natural backgrounds



Adding atmosphere for scene



Product shooting

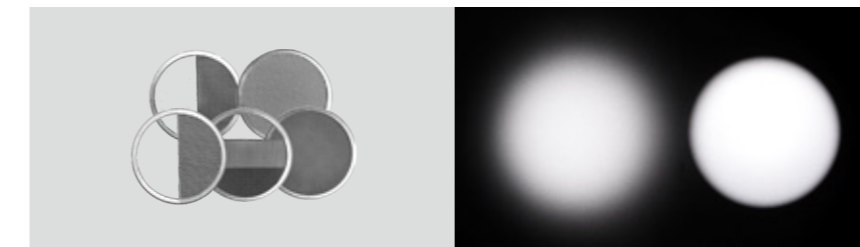

SA-05 Scrim set

To reduce the light intensity and control the light graduation.



SA-07 Scrim set

To reduce the light intensity and control the light graduation.



PANEL LIGHTS



SPECS

Model	P600Bi Hard	P600R Hard/P1200R Hard	P300R/P600R
Luminance	11,400Lux @3m (5600K)	8,980Lux /17,100Lux @3m (5600K)	1,620Lux/3,230Lux @3m (5600K)
Color Version	Bi-color	Full-color	Full-color
CCT	2800K-6500K	1800K-10000K	1800K-10000K
Max. Power	650W	700W/1500W	350W/700W
Color Rendering	CQS≥93/CRI≥96/TLCI≥96	CQS=95/CRI≥96/TLCI≥96	CQS≥95/CRI≥96/TLCI≥96
Controls	CRM/DMX/App/On-board/Remoter	CRM/DMX/App/On-board	CRM/DMX/Ethernet/App/On-board
Power Supply	AC	AC	AC/DC 48V
Dimension(Yoke included)	571*499*121mm	496*570*119mm/834*606*170mm	563*498*155mm/776*567*153mm
Weight	10kg	11.22kg/18.5kg	11.6kg/17.8kg

LED Light Panel | P600Bi Hard



LED Light Panel | P600Bi Hard



POWER
650_w
Power 650W

2800K-6500K

93,800Lux at 1 meter

LumenRadio CRMX

10_{KG}
Lightweight 10KG

P600Bi Hard

- CCT: 2800K-6500K
- 650W full output across all color temperatures
- A 10kg 1x1 panel
- 93,800Lux at 1 meter
- Precisely designed optical lens
- CRI≥96, TLCI≥96
- 0.1% stepless adjustment from 0.1% to full power
- Controls: DMX & CRMX, App control, 2.4GHz remote, on-board
- Aerospace-grade heat dissipation



Combined use as key light



Interior lighting



Green screen lighting solution



P600Bi Hard

- Light Body ×1
- Tying Rope ×1
- Safety Rope ×1
- Hex Wrench ×1
- U-type Bracket ×1
- Antenna ×1
- AC Power Cable ×1

Optional Purchase

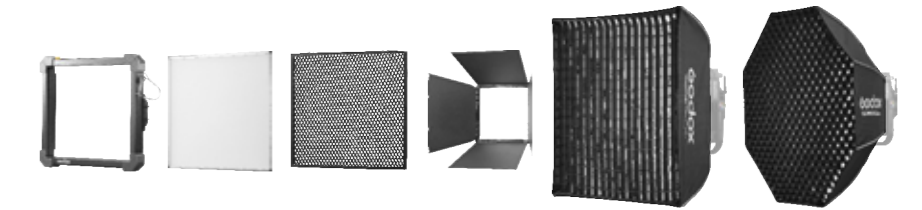

- P600RH AD Adapter
- P300RD Diffusion
- P300RH30 Honeycomb
- P300RB4 Barn door
- P300RS33 Rectangular Softbox
- P300R04 Octa Softbox

Compatible with certain accessories of P300R when using Adapter P600RH AD

Optional Purchase



Space Light Softbox P600BHSS



Rectangular Softbox (24"x24") P600BHS22



2-light Bracket AB02



4-light Bracket AB04



Junior Offset Arm HJ02



Junior Multi-header HJ04



Softbox (2'x3') for AB02 AB02S23



Softbox (3'x3') for AB02 AB04S33



Full-Color
Capability



Super Brightness



High Color
Consistency



Compact and
Lightweight



Hard/Soft
Switching



Stable CRMX
Control

P600R Hard/P1200R Hard

- CCT: 1800K-10000K
- Full-color capability
- Super power in compact size:
 - P600R Hard: 650W 1x1 panel
 - P1200R Hard: 1200W 2x1 panel
- CQS≥95, CRI≥96, TLCI≥96
- Controls: DMX, CRMX, App, and on-board control
- Hard/soft switching with diffusion panels
- Precisely designed optical lens
- High efficient heat dissipation

LED Light Panel | P600R Hard/P1200R Hard

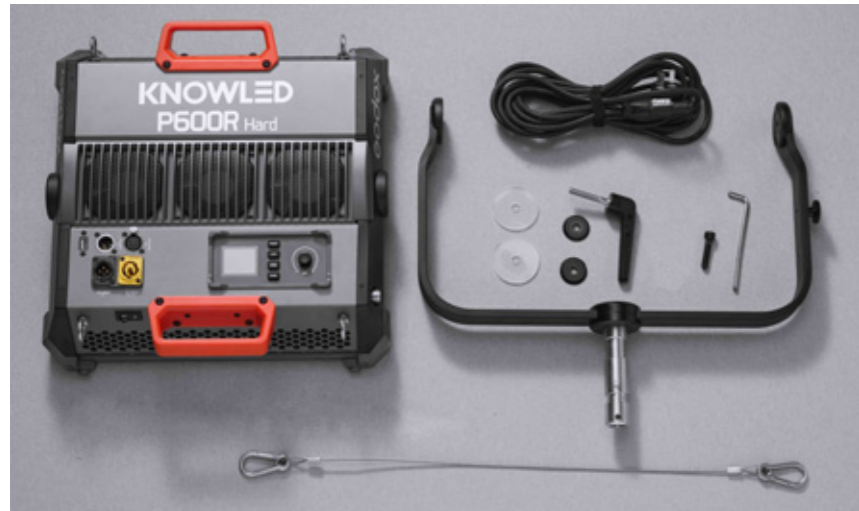

P600R Hard

- | | | | |
|----------------------------|----|-------------|----|
| Light Body | x1 | Main Cable | x1 |
| Metal Spacer | x2 | Safety Wire | x1 |
| Direction Adjusting Handle | x1 | Screw | x1 |
| Yoke | x1 | HexWrench | x1 |
| Plastic Spacer | x2 | | |

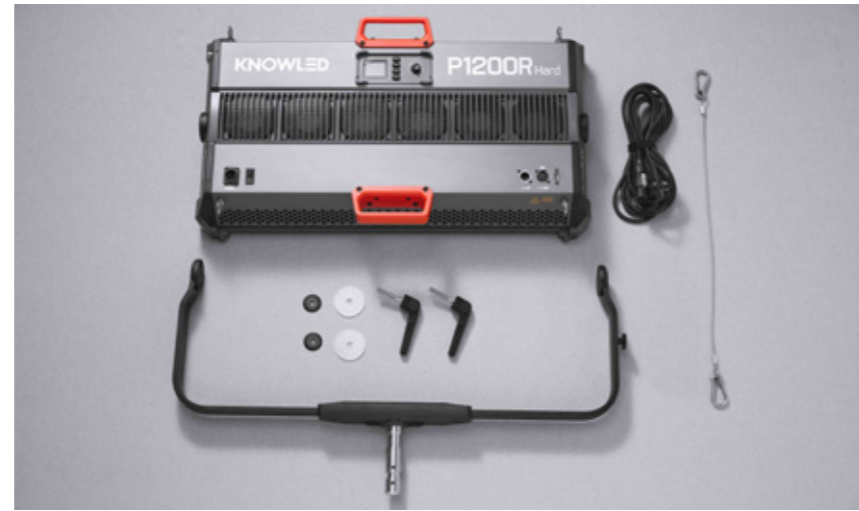

P1200R Hard

- | | | | |
|----------------------------|----|-------------|----|
| Light Body | x1 | Main Cable | x1 |
| Metal Spacer | x2 | Safety Wire | x1 |
| Direction Adjusting Handle | x1 | | |
| Yoke | x1 | | |
| Plastic Spacer | x2 | | |

Optional Purchase for P600R Hard



P600BHSS
Space Light Softbox



P600BHS22
Rectangular Softbox
(24"x24")



SCH01
Sling Chain



AB02
2-Light Bracket



AB04
4-Light Bracket



HJ02
Junior Offset Arm



HJ04
Junior Multi-Header

LED Light Panel | P600R Hard/P1200R Hard



AB02S23
Softbox (2'x3') for AB02

AB04S33
Softbox (3'x3') for AB04

Optional Purchase for P1200R



P1200RHSS
Space Light Softbox



SCH02
Sling Chain

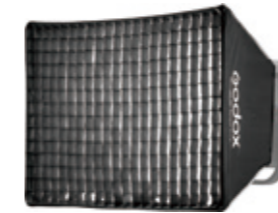

P1200RHS23
Rectangular Softbox



P600RH AD Adapter P600RHDo Domed Diffuser P300RD Diffusion P300RH30 Honeycomb P300RB4 Barndoor P300RS33 Rectangular Softbox P300R04 Octa Softbox

Compatible with certain accessories of P300R when using Adapter P600RH AD

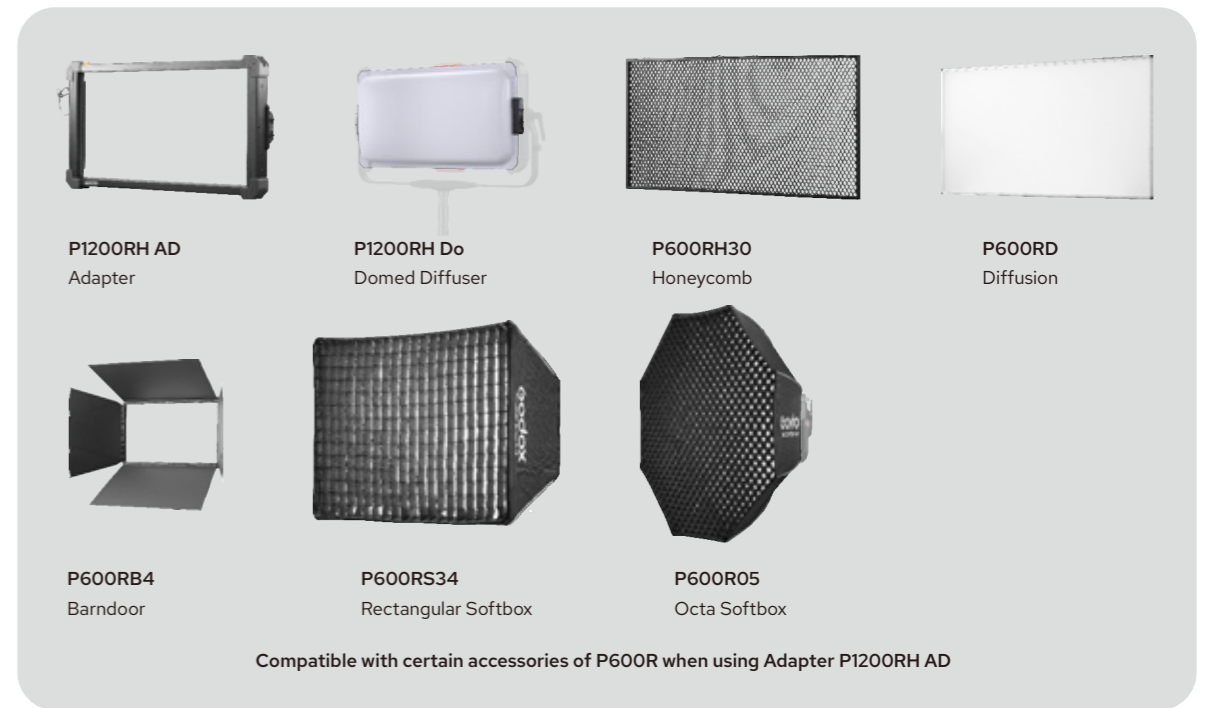

P1200RH AD Adapter P1200RH Do Domed Diffuser P600RH30 Honeycomb P600RD Diffusion

P600RB4 Barndoor P600RS34 Rectangular Softbox P600R05 Octa Softbox

Compatible with certain accessories of P600R when using Adapter P1200RH AD

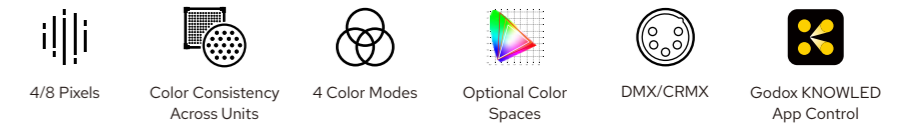

P300R/P600R

- Full-color capability
- CCT: 1800K-10000K
- Ideal for virtual production applications
- Compact size with higher pixel density in 1x1 ft (4 pixels) and 1x2 ft (8 pixels) options
- Godox's color calibration ensures consistent hues across all units from KNOWLED series
- Color spaces including Rec.2020, DCI-P3, and Rec.709
- High brightness with soft light quality
- Flicker-free performance
- CQS≥95, CRI≥96, TLCI≥96
- High-efficiency cooling fan for sustained performance
- Controls: DMX, CRMX, Ethernet, Bluetooth app control, on-board control
- Diverse accessory options available

LED Light Panel | P300R/P600R



P300R

Light Body	x1	Safety Wire	x1
Typing Rope	x1	Main Cable	



P600R

Light Body	x1	Safety Wire	x1
Typing Rope	x1	Main Cable	



P300R K1 Kit

Light Body	x1	Main Cable	x1
Typing Rope	x1	Quick Setup Softbox	x1
Safety Wire	x1	Soft Case SC02	x1



P600R K1 Kit

Light Body	x1	Main Cable	x1
Typing Rope	x1	Quick Setup Softbox	x1
Safety Wire	x1	Soft Case SC04	x1

Optional Purchase for P300R



P300RH30 Honeycomb 30°	Safety Wire SWO1	P300RB4 Barndoor	P300R1IG Grid(for Bare Light)	P300RS33+P300RS33G Softbox 3'x3'+Grid	P300R04+P300R04G Softbox Octa 4'+Grid	AB02 2-Light Bracket	AB04 4-Light Bracket
---------------------------	---------------------	---------------------	----------------------------------	--	--	-------------------------	-------------------------

LED Light Panel | P300R/P600R



AB02S23 Softbox (2'x3') for AB02	AB04S33 Softbox (3'x3') for AB04	MC8B Main Cable	P300RY02 P.O.Yoke	P300RY03 Double Vertical Yoke	P600BHSS Space Light Softbox	P600BHS22 Rectangular Softbox (24"×24")	SC02 Soft Case
-------------------------------------	-------------------------------------	--------------------	----------------------	----------------------------------	---------------------------------	---	-------------------

Optional Purchase for P600R



P600RH30 Honeycomb 30°	P600RB4 Barndoor	P600RS23+P600RS23G Softbox 2'x3'+Grid	P600RS34+P600RS34G Softbox 3'x4'+Grid	P600R05+P600R05G Softbox Octa 5'+Grid
---------------------------	---------------------	--	--	--



P600RY02 P.O.Yoke	P600RY03 Double Vertical Yoke	SC04 Soft Case	Safety Wire SWO1	MC8B Main Cable	Grid(for Bare Light) P600R12G
----------------------	----------------------------------	-------------------	---------------------	--------------------	----------------------------------



FLEXIBLE LED MAT

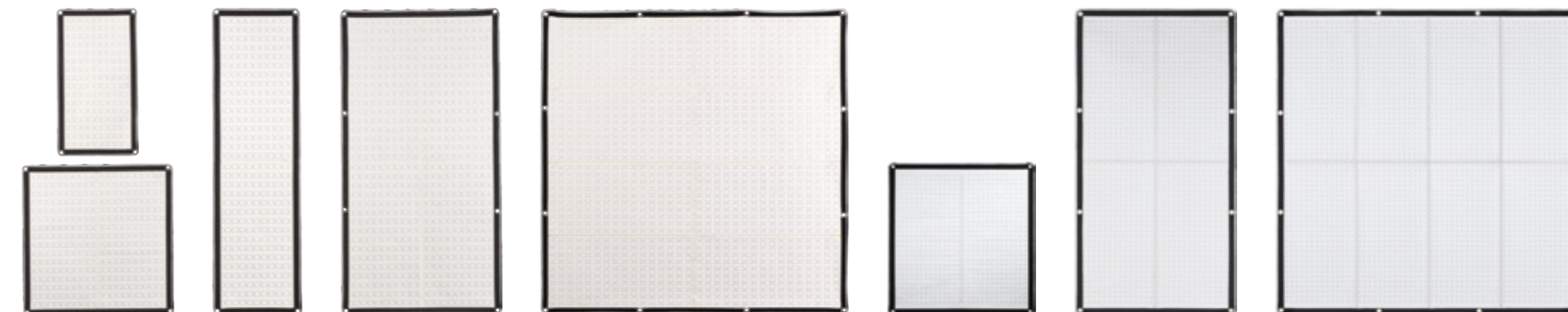

SPECS

Model	F100R	F200R	F200SR	F400R	F800R	F200Bi	F400Bi	F600Bi
Luminance	4740Lux @1m(5600K)	8900Lux @1m(5600K)	7900Lux @1m(5600K)	14400Lux @1m(5600K)	24200Lux @1m(5600K)	1,130Lux @3m (5600K)	2,280Lux @3m (5600K)	3,240Lux @3m (5600K)
Color Version	Full-color	Full-color	Full-color	Full-color	Full-color	Bi-color	Bi-color	Bi-color
CCT	1800K-10000K	1800K-10000K	1800K-10000K	1800K-10000K	1800K-10000K	2700K-8500K	2700K-8500K	2700K-8500K
Max. Power	130W	250W	250W	460W	900W(Max.)	210W	410W	670W
Color Rendering	CRI≥96/TLCI≥98	CRI≥96/TLCI≥98	CRI≥96/TLCI≥98	CRI≥96/TLCI≥97	CRI≥96/TLCI≥97	CRI≥96/TLCI≥96	CRI≥96/TLCI≥96	CRI≥96/TLCI≥96
Controlling Methods	DMX/LumenRadio CRMX/ Bluetooth app Control	DMX/LumenRadio CRMX/ Bluetooth app Control	DMX/LumenRadio CRMX/ Bluetooth app Control	DMX/LumenRadio CRMX/ Bluetooth app Control	DMX/LumenRadio CRMX/ Bluetooth app Control	DMX/App/On-board/Remoter/ Bluetooth app Control	DMX/App/On-board/Remoter/ Bluetooth app Control	DMX/App/On-board/Remoter/ Bluetooth app Control
Power Supply	100V-240V~50/60Hz	100V-240V~50/60Hz	100V-240V~50/60Hz	100V-240V~50/60Hz	100V-240V~50/60Hz	AC/DC 48V/V-mount battery	AC/DC 48V/V-mount battery	AC/DC 48V/V-mount battery
G/M Adjust	-100%~100%	-100%~100%	-100%~100%	-100%~100%	-100%~100%			
Protection Grade of	IP54	IP54	IP54	IP54	IP54	IP65	IP65	IP65
Light Body/Controller								
Dimension [±]	Bare Light Body: 344*636mm Controller: 154*128*232mm	Bare Light Body: 637*637mm Controller: 154*128*232mm	Bare Light Body: 344*1220mm Controller: 154*128*232mm	Bare Light Body: 637*1221mm Controller: 208*161*322mm	Bare Light Body: 1221*1221mm Controller: 190*166*366mm	650*631*29mm 124*132*270mm	1209*627*23mm 124*132*270mm	1210*1210*24mm 179*123*332mm
Netweight [±]	Bare Light Body: 0.6kg Controller: 2.8kg	Bare Light Body: 1kg Controller: 2.8kg	Bare Light Body: 1.05kg Controller: 2.8kg	Bare Light Body: 1.8kg Controller: 5.8kg	Bare Light Body: 3kg Controller: 6.5kg	1.83kg 2.77kg	3.1kg 3.07kg	3.8kg 3.9kg

F100R



F200R



F200SR

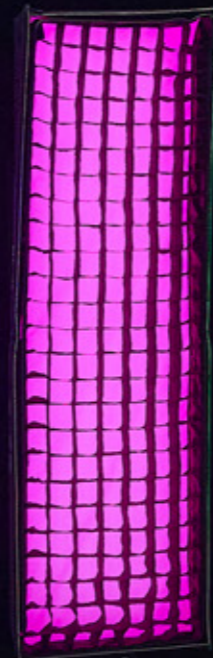

F400R

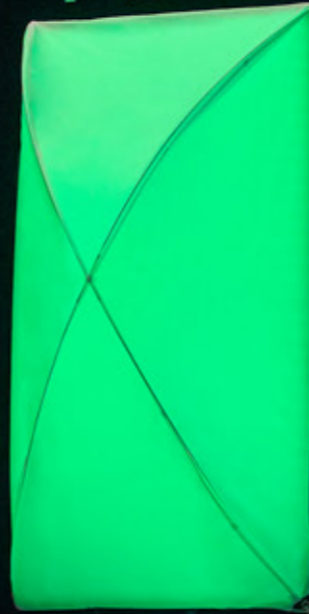

F800R

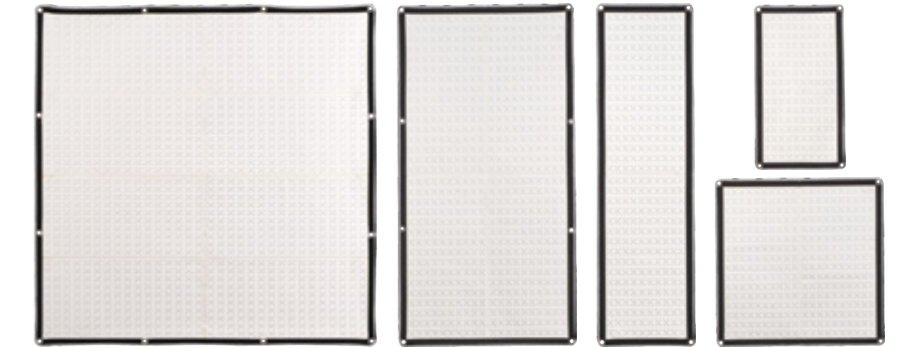
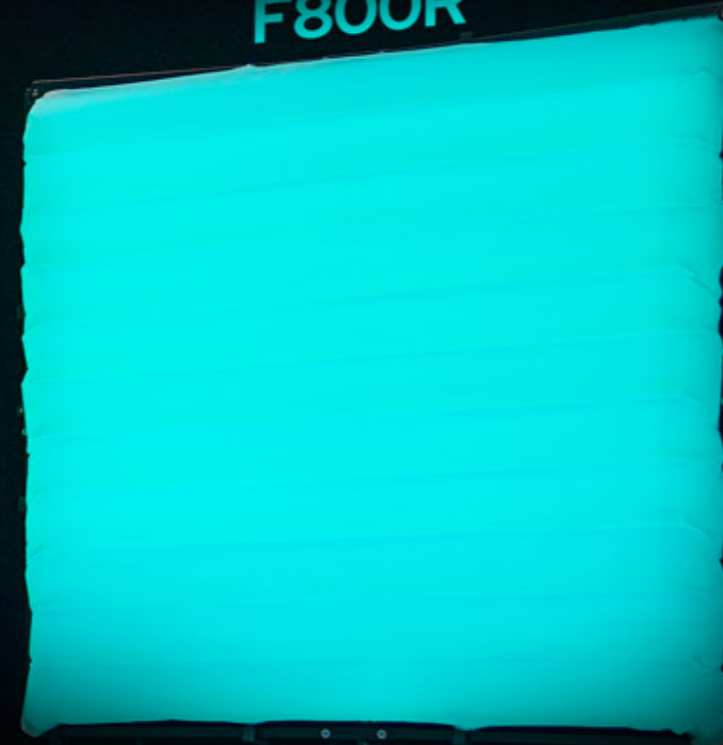

Bright full color



Lightweight & foldable



Five sizes



Detachable air softbox



CRMX control

F100R/200R/200SR/400R/800R

- Full-Color Brightness for Every Scene
- Five Sizes: 1'2/2'*2/1'4/2'*4/4'*4'
- Light mats in 100W, 200W, 400W, 800W Options
- Compact and flexible for tight spaces
- High power in a slim design
- Light head IP54, control box IP54
- CCT range from 1800K to 10000K, adjustable G/M
- New air softbox available for each size
- Enhanced frame stability, high-quality softbox, QUICK installation
- CRI96+, TLCI 97+
- DMX512 Control/LumenRadio CRMX/Ethernet/Bluetooth app Control
- Power Options: AC,DC 48V, V-mount batteries

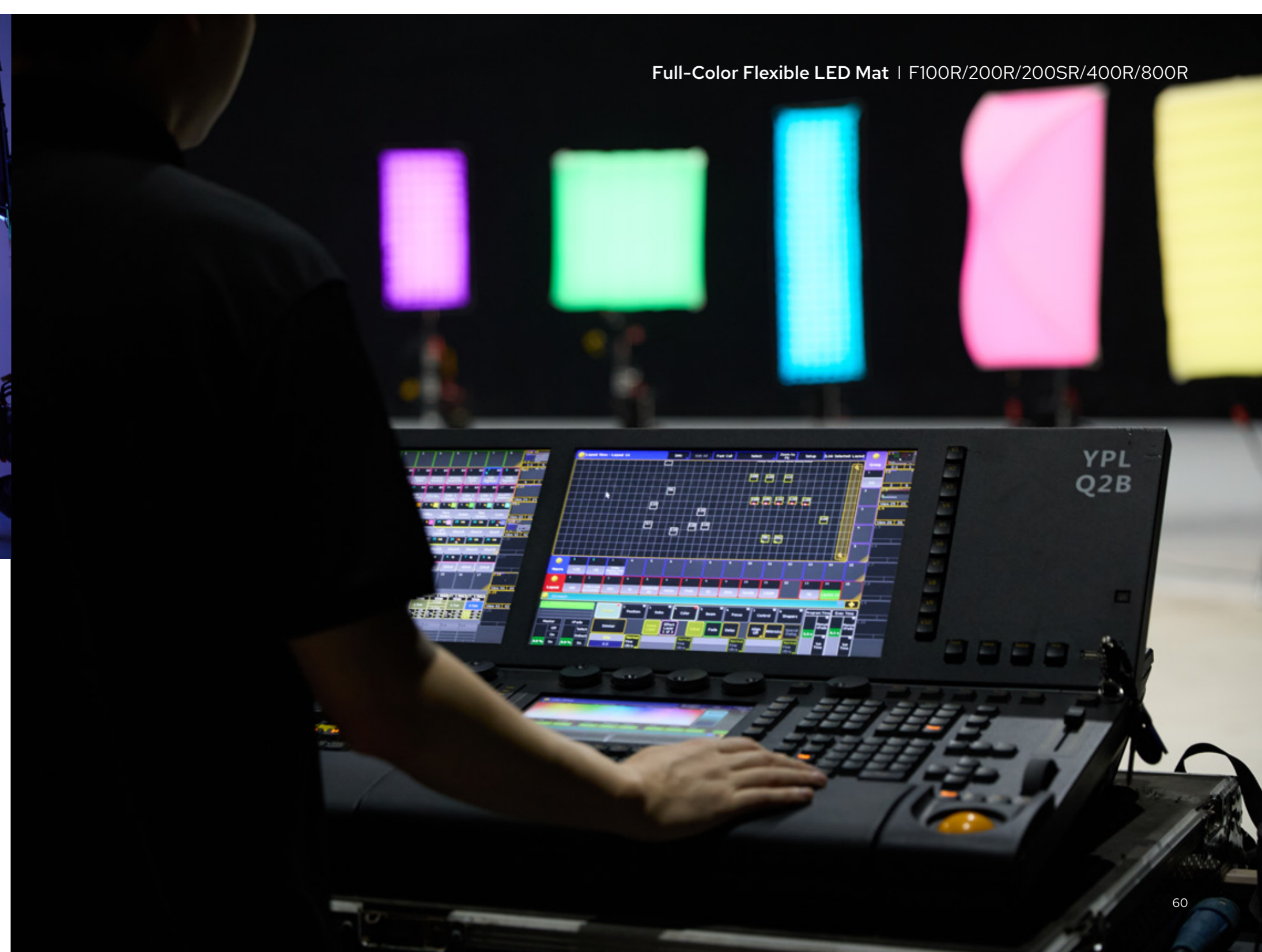

Space-Constrained Solution



Soft Light Film Set

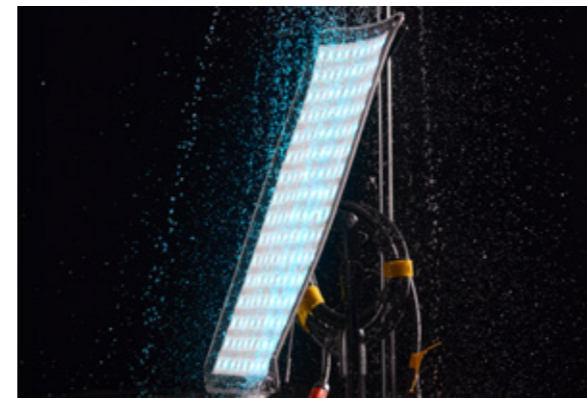

Rainy Day Shooting

Full-Color Flexible LED Mat | F100R/200R/200SR/400R/800R



F100R K1

Light Body	x1	X Bracket	x1
DC Connection Cable	x1	Light Stand Mounting Adapter	x1
Softbox FS100	x1	Controller	x1
AC Power Cable	x1	Carrying Bag	x1

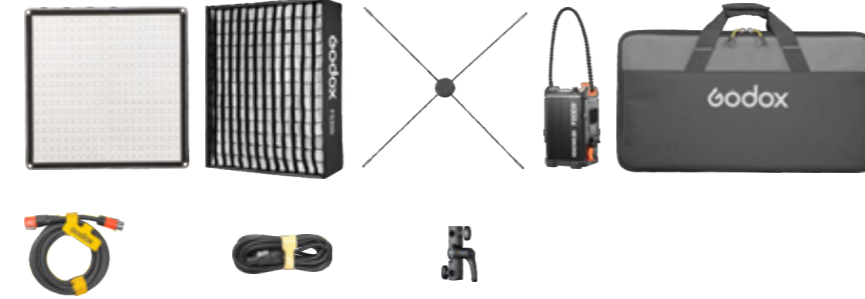

F200R K1

Light Body	x1	X Bracket	x1
DC Connection Cable	x1	Light Stand Mounting Adapter	x1
Softbox FS200	x1	Controller	x1
AC Power Cable	x1	Carrying Bag	x1

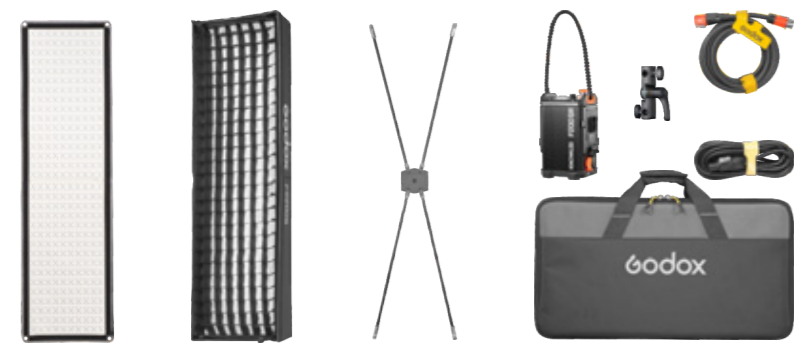

F200SR K1

Light Body	x1	X Bracket	x1
DC Connection Cable	x1	Light Stand Mounting Adapter	x1
Softbox FS200S	x1	Controller	x1
AC Power Cable	x1	Carrying Bag	x1



F400R K1

Light Body	x1	Light Stand Mounting Adapter	x1
DC Connection Cable	x1	Controller	x1
Softbox FS400	x1	Carrying Bag	x1
AC Power Cable	x1	Protective Cloth	x1
X Bracket	x1		

Full-Color Flexible LED Mat | F100R/200R/200SR/400R/800R



F800R K1

Light Body	x1	Metal Frame	x1
DC Connection Cable	x1	Protective Cloth	x1
Softbox FS800	x1	Controller	x1
AC Power Cable	x1	Carrying Case	x1

Optional Purchase

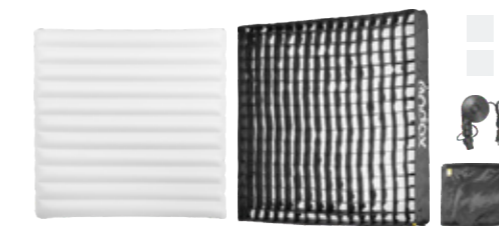

Air Softbox Kit

Air Softbox body×1 Grid×1 Skirt×1 Air Pump×1 Repair Patch×2
 FA800 for F800R/FA400 for F400R
 FA200S for F200SR/FA200 for F200R
 FA100 for F100R



AT200

Air Tube×1 Skirt×1 Grid×1 Air Pump×1
 Repair Patch×2 Fabric Handle×2
 Connecting Holder×1 Velcro Hook Fastener×1



Pancake Lantern

FP600 for F800R
 FP400 for F400R
 FP200 for F200R



Skirt for K1 Softbox Kit

SS-FS800 for FS800/SS-FS400 for FS400
 SS-FS200S for FS200S/SS-FS200 for FS200
 SS-FS100 for Fs100



5m DC Cable

F-DC5D for F200R/F200SR/F100R
 F-DC5E for F400R/F800R



10m DC Cable

F-DC10E for F400R/F800R



Controller Clamp PC01



Adjustable Support Bracket BP01
 For F800R

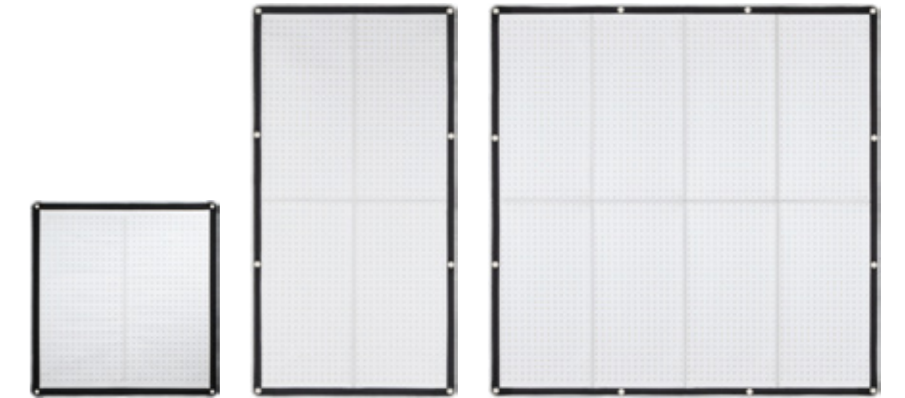

Foldable



Lightweight

IP65

Water-resistance



2700K-8500K

F200Bi/F400Bi/F600Bi

- CCT: 2700K-8500K
- Slim and flexible design suitable for use in narrow or curved spaces
- LED mats in 200W, 400W, 600W options
- Consistent full power output across all color temperatures
- CRI 96+, TLCI 96+
- Linear/S-Curve/Logarithmic/Exponential dimming curve
- Light body with a foldable design and IP65 water resistance
- High-quality aluminum alloy frame construction
- Easy to fold and transport
- Controls: DMX, App control, 2.4GHz remote, on-board
- CRMX support with optional TimoLink receiver (Sold Separately)
- Power options: AC, DC 48V, and V-mount batteries

Flexible LED Mat | F200Bi/F400Bi/F600Bi



Flexible LED Mat | F200Bi/F400Bi/F600Bi



F200Bi

Light Body	×1	5m Power Cable	×1
Control Box	×1	Adapter Holder	×1
X Bracket	×1	Softbox with Grid FS200	×1
3m Connect Cable	×1	Carry Bag CB87	×1



F400Bi

Light Body	×1	5m Power Cable	×1
Control Box	×1	Adapter Holder	×1
X Bracket	×1	Softbox with Grid FS400	×1
3m Connect Cable	×1	Carry Bag CB87	×1



F600Bi

Light Body	×1	Softbox with Grid FS600	×1
Control Box	×1	Carry Bag CB88	×1
3m Connect Cable	×1	Detachable metal frame MB-F600	×1
5m Power Cable	×1		

Optional Purchase



Pancake Lantern
FP200 for F200Bi
FP400 for F400Bi
FP600 for F600Bi

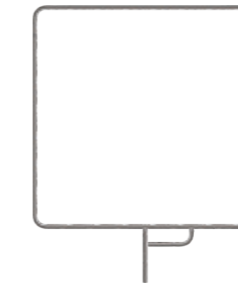

Flag Frame
FF200 for F200Bi



Remote Control
RC-R9II or RC-A6II



5m DC Cable
F-DC5A for F200Bi
F-DC5B for F400Bi
F-DC5C for F600Bi



Nano Clamp
L SA-03&LSA-19



Wireless DMX Transmitters
and Receivers
TimoL ink TX/TimoL ink RX



Hanging use for close-up shot



Indoor on-location lighting



Narrow-space lighting



TUBE LIGHTS

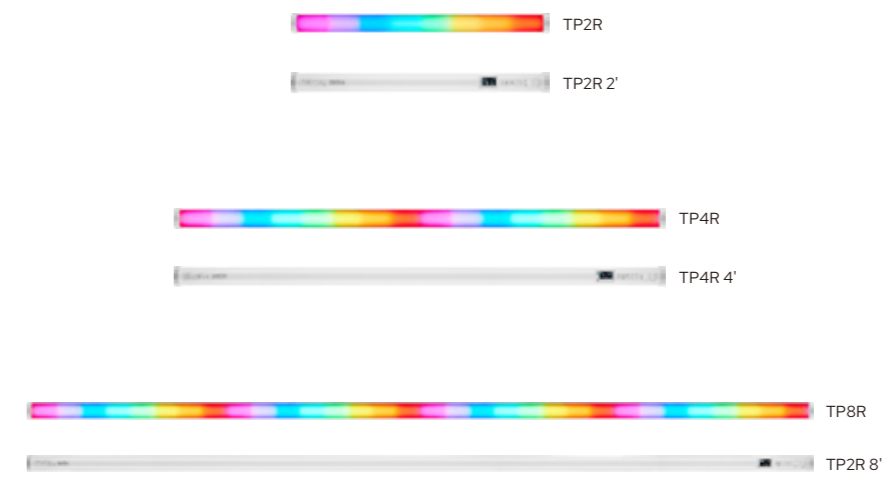

SPECS

Model	TP2R	TP4R	TP8R
Luminance	565Lux @1m (5600K)	765Lux @1m (5600K)	994Lux @1m (5600K)
Color Version	RGBWW	RGBWW	RGBWW
CCT	2000K-10000K	2000K-10000K	2000K-10000K
Pixels	16	32	64
Max. Power	26W	47W	83W
Color Rendering	CRI≥96/TLCI≥97	CRI≥96/TLCI≥97	CRI≥96/TLCI≥97
Controls	CRMX/DMX/App/On-board/Remoter	CRMX/DMX/App/On-board/Remoter	CRMX/DMX/App/On-board/Remoter
Built-in Battery	Included	Included	Included
Power Supply	AC/built-in battery	AC/built-in battery	AC/built-in battery
Dimension	47*47*600mm	47*47*1200mm	47*47*2400mm
Weight	0.84kg	1.5kg	2.94kg



TP2R

TP2R 2'

TP4R

TP4R 4'

TP8R

TP2R 8'

High pixel density

For Mapping Use

Lumen Radio CRMX

180° Rotatable Screen

2000K-10000K

TP2R/TP4R/TP8R

- High pixel density: 16(TP2R)/32(TP4R)/64(TP8R)
- Sizes: 2'(TP2R)/4'(TP4R)/8'(TP8R)
- CCT: 2000-10000K
- RGBWW capable
- CRI≥96, TLCI≥96
- Controls: DMX & CRMX, App control, 2.4GHz remote, on-board
- Selectable 8-bit & 16-bit modes
- 14 built-in FX effects
- 180° rotatable on-board screen for easy reading
- Excellent diffusion panel

RGBWW Pixel Tube Light | TP2R/TP4R/TP8R



Car scene lighting



Music video lighting



Pixel mapping

RGBWW Pixel Tube Light | TP2R/TP4R/TP8R



TP2R

Four-light Kit for TP2R

- 2' Pixel Tube light ×1
- One for Two Adapter ×1
- Power Cord ×1
- Clip ×1
- Bolt ×1
- Steel Rope ×1
- Carry Case CB76 ×1



TP2R-K4

Four-light Kit for TP2R

- 2' Pixel Tube light ×4
- One for Two Adapter ×2
- Power Cord ×2
- Clip ×4
- Bolt ×8
- Steel Rope ×8
- Carry Case CB76 ×1



TP4R-K4

Four-Light Kit for TP4R

- 4' Pixel Tube light ×4
- One for Two Adapter ×2
- Power Cord ×2
- Clip ×8
- Bolt ×8
- Steel Rope ×8
- Carry Case CB77 ×1



TP8R-K8

Eight-light Kit for TP4R

- 4' Pixel Tube Light ×8
- Power Box ×1
- Power Cord ×1
- Clip ×16
- Double Male Straight DC Cord ×8
- Bolt ×16
- Steel Rope ×16
- Carry Case CB79 ×1

Optional Purchase



Two-light Bracket Kit
TP-B2 (for TP2R/TP4R)



Four-light Bracket Kit
TP-B4 (for TP2R/TP4R)



Eight-light Bracket Kit
TP-B8 (for TP2R/TP4R)



Softbox TP-S2/TP-S4



Air Soft Tube
TP-S2A/TP-S4A



Power Box
TP-P600



Grid
TP-G2



Grid
TP-G4



Grid
TP-G8



Floor Stand
TP-FS60



Multi-tube Light
Connector TP-M2



DMX Adapter
Cable DMX-C1



TimoLink TX
Wireless DMX Transmitter



One for Two Adapter
TP-A2R/TP-A4R/TP-A8R



10m Power Cable
AC10A



5m DC Cable
TP-DC5



D-TAP to DC Male
Connector Cable DT-C1



AIR TUBE LIGHT



SPECS

Model	AT200Bi
Power Supply	100V-240V~50/60Hz 2.1A
Max. Power	≈210W
CCT	2700-8500K
Brightness Range	0%-100%
Dimming Curves	linear, s-curve, exponential, logarithmic
FX Modes	11
CRI	Average≥96
TLCI	Average≥96
Waterproof Grade of Light Body	IP65
Controlling Methods	DMX 512 Control (support RDM protocol), 2.4GHz Wireless Control, Bluetooth APP Control
Bluetooth Controlling Distance	Max. 30m
2.4G Remote Control Distance	Max. 60m
Type-A USB Port	Firmware Upgrade/5V=1A Power Supply
Dimension	Light Body: 280mm*267mm*1226mm/11*11*48" (With air bag and in the inflated state, does not include the connection cable.) Controller: 124mm*132mm*270mm
Netweight≈	Light Body: 2.15kg (Including airbag)/Controller: 2.8kg



180° Light Emission



200W Output



Multiple Controls



2700K-8500K



Detachable Design

AT200Bi

- CCT: 2700K-8500K
- LED mat with an inflatable softbox for soft, even lighting
- Handheld, suspended, or stand-mounted options
- Modular design for easy maintenance
- Multiple control options including DMX512, app control, and wireless remote
- Controls: DMX, App control, and wireless remote
- Maximum power of 210W
- High CRI and TLCI ratings above 96
- IP65 weather-resistant light body
- Sweeping 180° generous beam spread
- AC power and V-mount battery support
- Foldable, lightweight design
- 11 built-in FX lighting effects

AMBIENT LIGHTS



SPECS

Model	C5R	C7R	C10R
Luminance	200Lux @1m (6500K)	101Lux @1m (5500K)	130Lux @1m (5500K)
Color Version	RGBWW	RGBWW	RGBWW
CCT	2500K-8500K	2000K-10000K	2000K-10000K
Max. Power	5W	7W	10W
Color Rendering	CRI=96/TLCI=96	CRI=96/TLCI=97	CRI=96/TLCI=97
Controls	On-board/App	On-board/App	On-board/App
Built-in Battery	Included	Included	Not included
Power Supply	5V/2A Type-C DC charging/ wireless charging/built-in battery	AC (lamp socket)/5V/ 2.5A Type-C DC charging/built-in battery	AC (lamp socket)/5V/ 3A Type-C DC charging
Dimension	106*68*18mm	73*73*136mm	73*73*136mm
Weight	169g	256g	236g

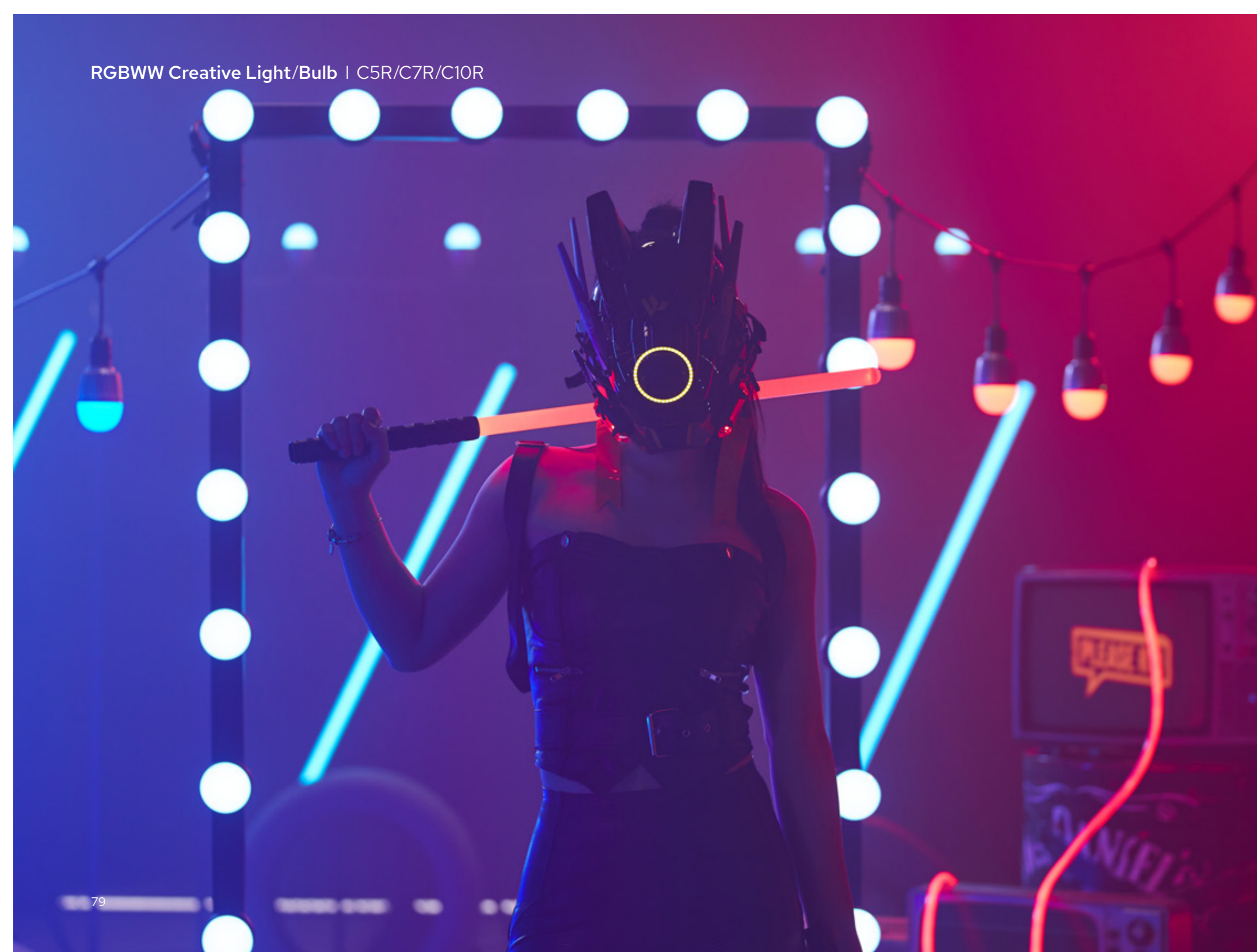

C5R

- Lightweight and portable
- CCT: 2500-8500K
- RGBWW capable
- CRI≥96, TLCI≥97
- Two independent dials for easy adjustment
- Magnetic back for easy attachment
- 39 FX effects for creative lighting
- Built-in 3000mAh lithium battery for 2-hours runtime at full output
- Wireless/Type-C charging
- Controls: Godox Light App, on-board
- Includes a collapsible diffuser
- Available in an 8-light charging kit

C7R/C10R

- Constant power design ensures stable lighting
- CCT: 2000-10000K
- Magenta-green adjustment.
- RGBWW capable
- Built-in battery for C7R
- CRI≥96, TLCI≥97
- Quick reset of bluetooth connection via on-board buttons
- Precise control via Godox Light App
- Power supply: AC/DC
- Available in E26 and E27 base options for versatile compatibility
- C7R available in an 8-light charging kit



Practical lighting



Ambient lighting



Colorful atmosphere

C5R



Light Body x1 Collapsible Diffuser x1 Carry Bag CB50 x1 Coldshoe Base x1 USB Type-c Cable x1

C5R-C8 Eight-light Charging Case for C5R



Charging Case x1
Charging Case Power Cord x1
USB-C Cable x2
D-TAP to DC Adapter Cable x1

C5R-K8 Eight-light Charging Case Kit for C5R



C5R x8
Collapsible Diffuser x8
Charging Case Power Cord x1
Charging Case x1
USB-C Cable x2
D-TAP to DC Adapter Cable x1
Cold Shoe Mount x2

C7R/C10R



Light Body x1 Storage Bag x1 Type-C Cable x1

Optional Purchase (for C7R/C10R)

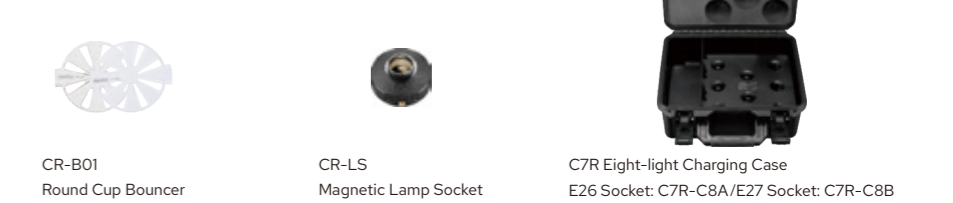

CR-B01 Round Cup Bouncer CR-LS Magnetic Lamp Socket C7R Eight-light Charging Case x1 E26 Socket: C7R-C8A/E27 Socket: C7R-C8B

Eight-light Charging Case Kit for C7R

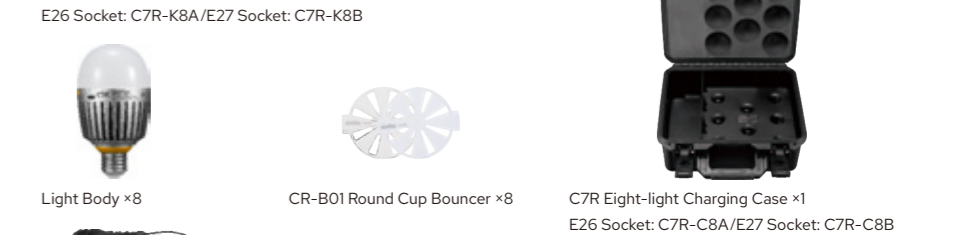

E26 Socket: C7R-K8A/E27 Socket: C7R-K8B Light Body x8 CR-B01 Round Cup Bouncer x8 C7R Eight-light Charging Case x1 E26 Socket: C7R-C8A/E27 Socket: C7R-C8B



Storage Bag for Round Cup Bouncer x2 1.5m Charging Case Power Cord x1 Type-C Cable x2

Eight-light Kit for C10R



E26 Socket: C10R-K8A/E27 Socket: C10R-K8B Light Body x8 CR-B01 Round Cup Bouncer x8 CB97 Carry Bag x1

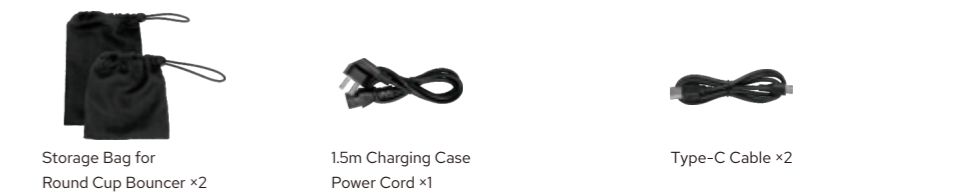

Storage Bag for Round Cup Bouncer x2 1.5m Charging Case Power Cord x1 Type-C Cable x2



CINE LIGHTING REFLECTOR



High Reflectance



Four Diffusion Types



Varied Sizes



Versatile Applications



Comprehensive Accessories

LiteFlow 7/15/25/50/100

- Exceptional reflectance with a mere 3% power loss
- A variety of diffused lighting effects: D1/D2/D3/D4
- Five size options: 7×7/15×15/25×25/50×50/100×100 cm
- Sleek rail structure with a guide slot design, ensuring seamless installation
- Leveraging the square inverse law to extend the light path
- Effortless adjustments for convenient control
- Directly utilizing natural sunlight to balance lighting contrast, even without artificial sources
- Redirecting a single light source multiple times, reducing the need for additional fixtures and light-shaping tools
- Mimicking natural light decay, guaranteeing even lighting across the illuminated area
- Varying sizes grant you precise control over the illuminated area
- Coming with a comprehensive range of accessories

LiteFlow 7



LiteFlow 7D1×1



LiteFlow 7D2×1



LiteFlow 7D3×1



LiteFlow 7D4×1



Soft Case SC13×1

LiteFlow 15



LiteFlow 15D1×1



LiteFlow 15D2×1



LiteFlow 15D3×1



LiteFlow 15D4×1



Soft Case SC14×1

LiteFlow 25



LiteFlow 25D1×1



LiteFlow 25D2×1



LiteFlow 25D3×1



LiteFlow 25D4×1



Soft Case SC15×1

LiteFlow 50



LiteFlow 50D1×1



LiteFlow 50D2×1



LiteFlow 50D3×1



LiteFlow 50D4×1



Soft Case SC16×1

LiteFlow 100



LiteFlow 100D1&D3×1 Yoke×1



LiteFlow 100D2&D4×1 Yoke×1

LiteFlow 100 K1



LiteFlow 100D1&D3×1 Yoke×1



LiteFlow 100D2&D4×1 Yoke×1



Flight Case FC04×1



Narrow space lighting



Utilizing sunlight outdoors



With high-output fixtures in low positions

LiteFlow K1/K2

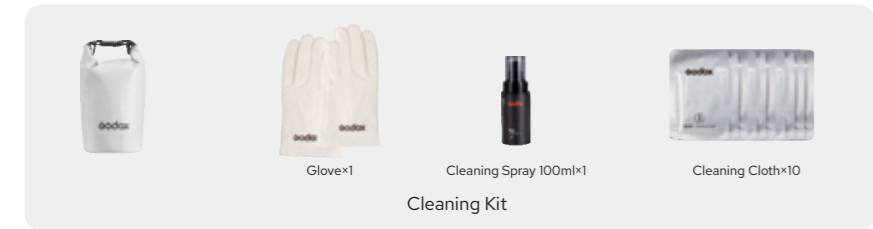

Optional Purchase



Rail Mount

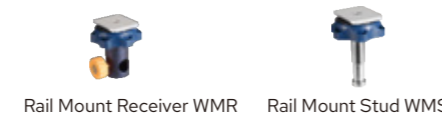

Gag

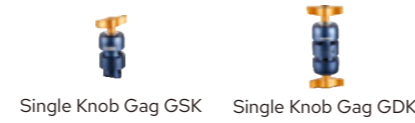

Rod Set

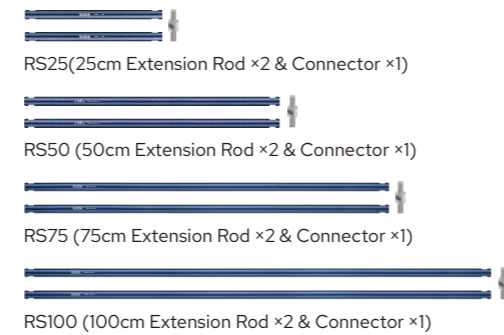

Multi-Adapter



Ball-Joint Arm



Flexible Arm (Important Note: Maximum load 1kg, restricted to use with LiteFlow 7/15/25.)



Multi-Reflector Array Grip Kit GK7

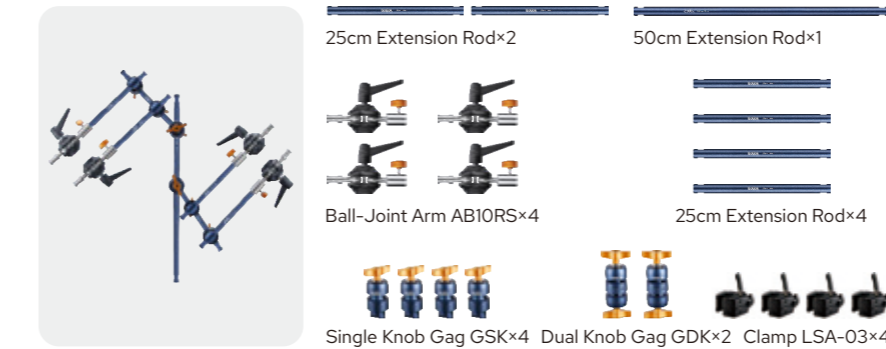

Multi-Reflector Array Grip Kit GK25

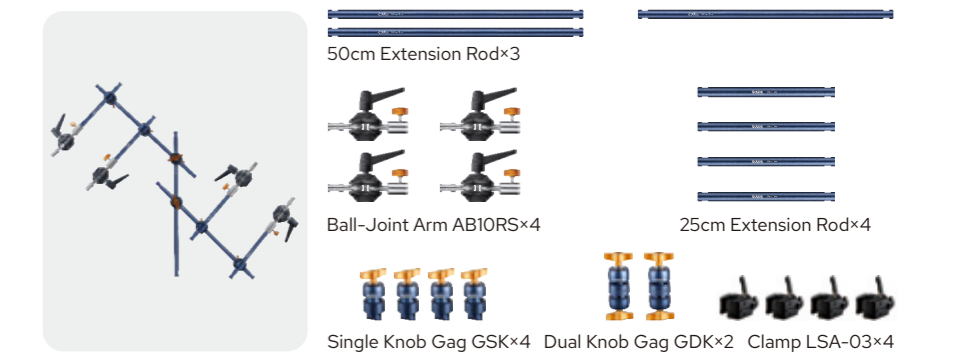

Multi-Reflector Array Grip Kit GK50

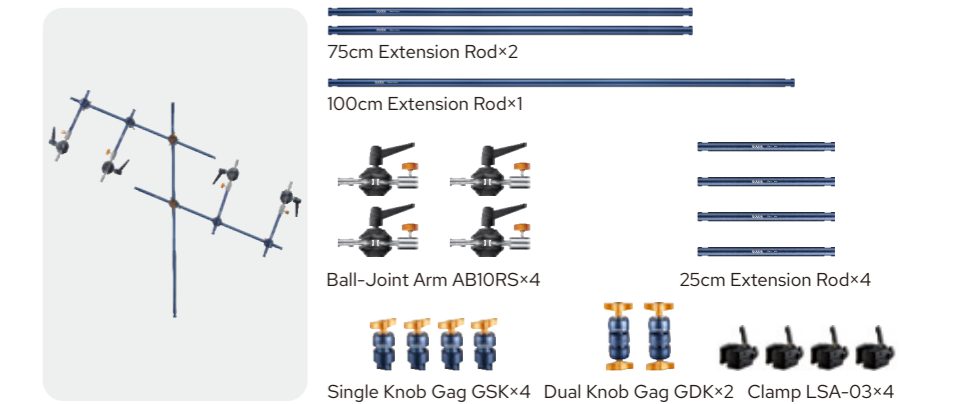

Cleaning Kit CK01



Safety Wire

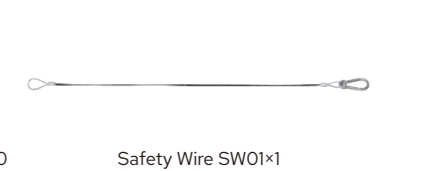

KNOWLED APP

- **Professional Lighting Control App:** Transform your tablet into a powerful DMX lighting console.
- **Universal Compatibility:** Manage lights of any brand with a universal DMX protocol.
- **Practical Lighting Layout Interface:** Seamlessly sync your on-set lights with a virtual grid for exact control.
- **Stability Across Connections:** Reliable wireless and wired connection options for uninterrupted control.
- **Customize Your Library:** Create a local DMX light fixture library tailored to your needs.
- **Intuitive and Clean Interface:** Navigate and control with ease, streamlining your lighting setup process.
- **Fader Mode:** Simulate a physical console's familiar experience with virtual sliders.
- **Control at Your Fingertips:** Make changes to lighting parameters through a graphic interface.
- **Lightweight Mobility:** Control all your lighting from your Android tablet or iPad – no heavy hardware needed.
- **Connectivity Your Way:** Choose between Bluetooth-CRMX and Ethernet Art-Net for versatile setup options.



Godox KNOWLED APP



CONTROL SYSTEM

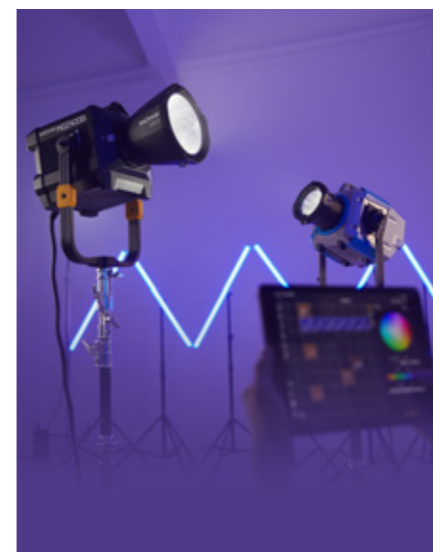

Stable connection with lights of any brand

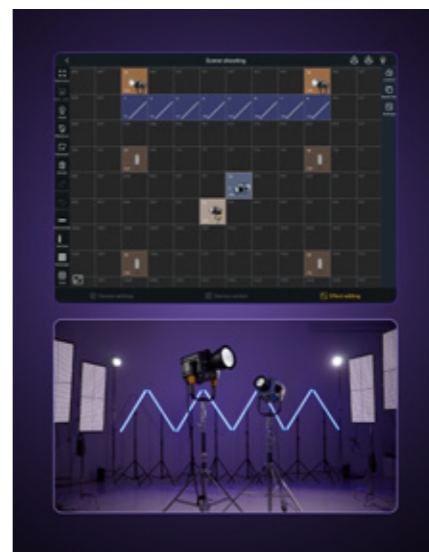

Position fixtures on the grid to match the setup

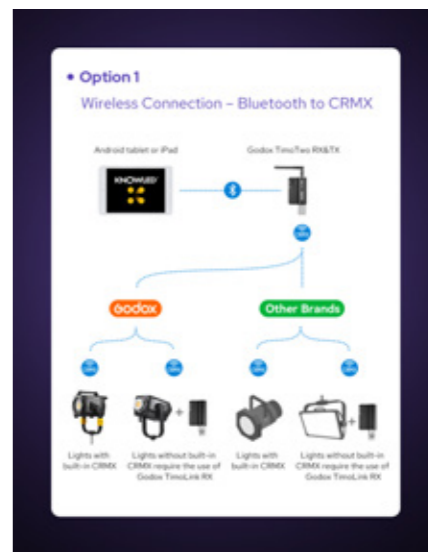

Wireless Connection - Bluetooth to CRMX

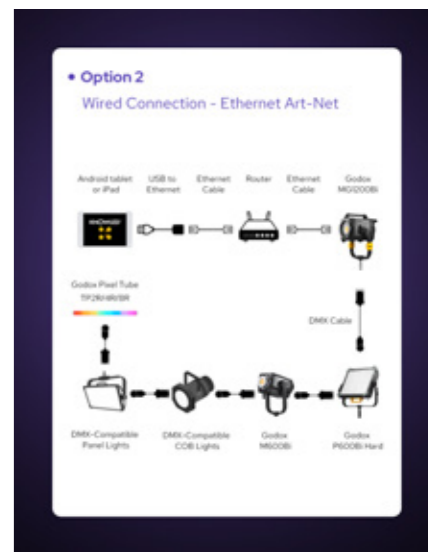

Wired Connection - Ethernet Art-Net



ACCESSORY



5° Beam Angle



Parallel Beam with Slow Decay



Punchy Lighting



G-Mount Compatibility



Incredible Throw and Illuminance

BeamLight Max90

- 5° Beam Angle
- Cinematic-grade parallel beam lighting with slow decay
- Incredible throw and illuminance comparable to 12K HMIs
- Punchy lighting
- An innovation parallel lighting solution with LiteFlow
- G-Mount Compatibility

BeamLight Max90

LiteFlow D1100

BeamLight Max90
MG2400Bi

LiteFlow D1 50

LiteFlow D1 25

LiteFlow D1 15

LiteFlow D2 25

Parallel lighting system with LiteFlow

280m+

BeamLight Max90

MG2400Bi

BeamLight Max90

Dimension

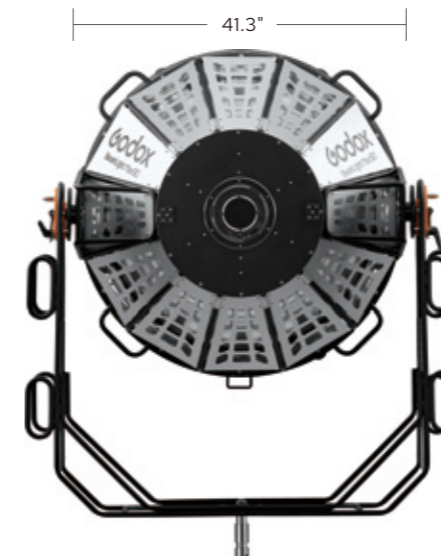



5° Beam

9.8 kg

Light Build



Protective Housing



Godox Bowers Mount/G-mount

BeamLight B60/Max60

- 5° Narrow Beam
- Parallel Beam System
- Compatible with KNOWLED and G-mount lights
- Easy setup, only 10kg
- Protective housing for long-term use

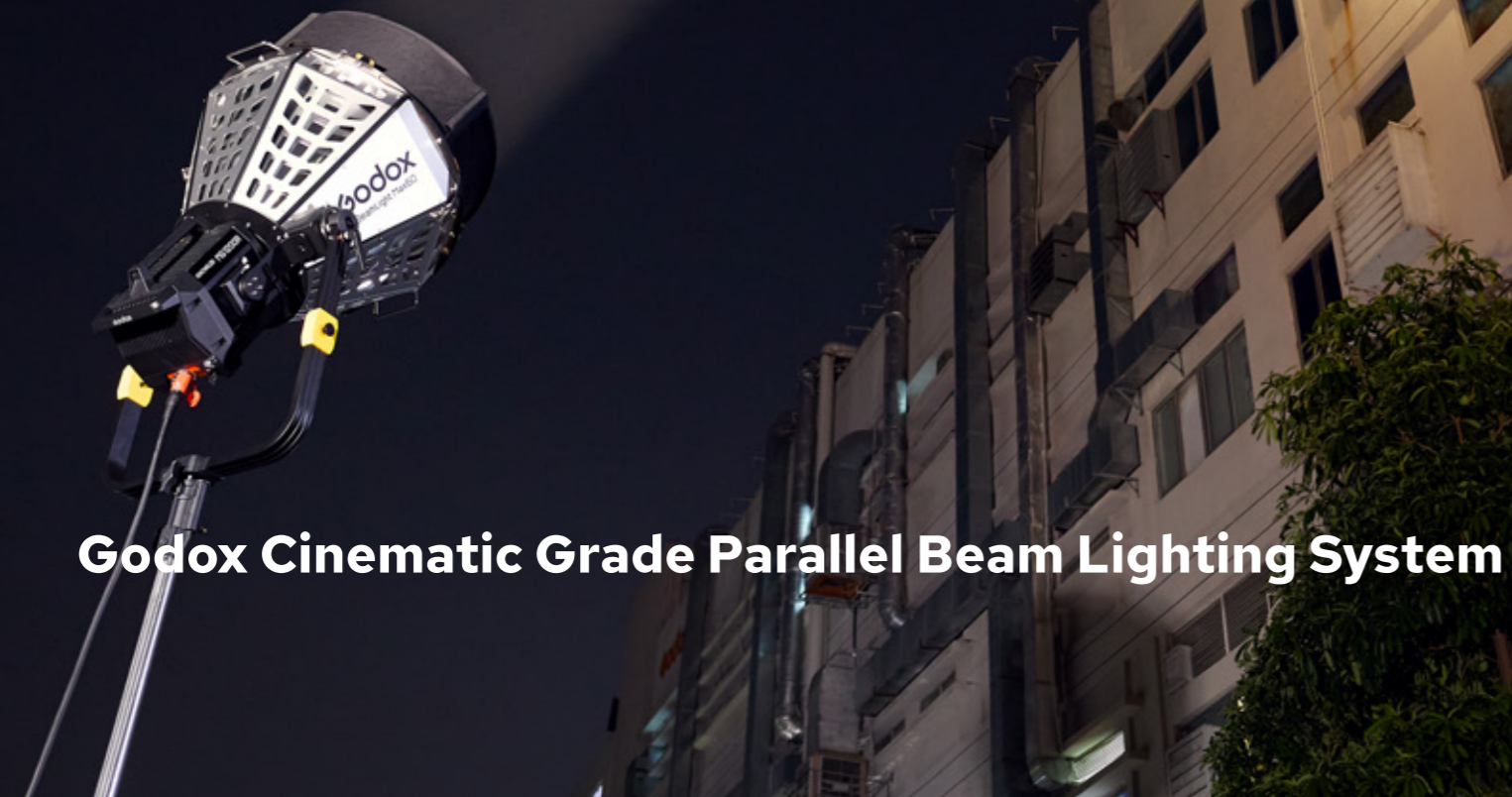

Godox Cinematic Grade Parallel Beam Lighting System



B60

B60	x1	Support rods	x1
Spill Control Fabric	x1	Flight case	x4



Max60

Max60	x1	Flight case	x1
Spill Control Fabric	x1	Reinforced Brackets	x2
Supportrods	x4	(for MG1200Bi, MG1200R)	

Dimension

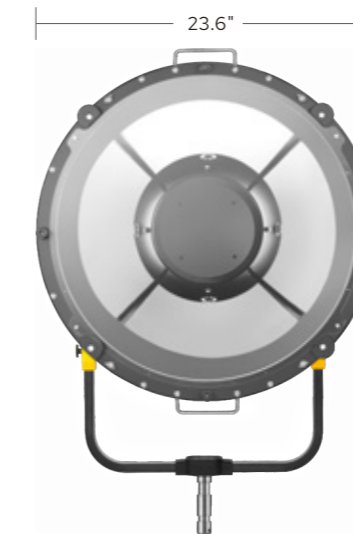

G-Mount Projection Attachment | GP19K/26K/36K



GP19K/26K/36K

- Evenly intensifying the illumination by times
- Project a crisp and clear beam without aberration
- Easily realizing versatile lighting effects with various accessories
- The rotatable handle allows more smooth and precise control
- Interchangeable lenses in 19°, 26°, 36°
- Efficient cooling system powered through G-Mount

Tech Specs

Mode	Dimension	Dimension
Projection attachment	418*647*727mm/16.5*25.5*28.6" (including lens)	≈11.6kg(excluding lens)
Lens 19°	281*235*289mm/11.1*9.3*11.4"	≈9.94kg
Lens 26°	281*235*289mm/11.1*9.3*11.4"	≈8.41kg
Lens 36°	281*234*287mm/11.1*9.2*11.3"	≈8.23kg



- GP19K/26K/36K Projector ×1
- Gobo Holder ×1
- Gobo Set ×1
- Portable Case ×1
- Lens ×1



Bowens Mount Projection Attachment | VSA-19K/26K/36K



VSA-19K/26K/36K

- Evenly intensify the illumination
- Project a crisp and clear beam without aberration
- Internal shutter blades for precise beam cutting
- With Gobos to create various backgrounds
- Three interchangeable lenses 19°, 26°, and 36°

Tech Specs

Mode	Dimension	Dimension
Projection attachment(excluding lens)	516*241*196mm/20.3*9.5*7.7"	3.42kg
Lens 19°	135*219*137mm/5.3*8.6*5.4"	1.94kg
Lens 26°	135*219*137mm/5.3*8.6*5.4"	1.94kg
Lens 36°	135*219*137mm/5.3*8.6*5.4"	1.94kg



- Spot Light Mount ×1
- 19°Lens/26°Lens/36°Lens ×1
- Gobo Holder ×1
- Gobo ×1
- Gel Frame ×1
- Portable Bag ×1



DL5 Parallel Booster



DL5 Parallel Booster



DL5 Parallel Booster

- Specifically Designed to Enhance the Performance of the S60Bi/D
- 5° narrow beam
- Seamless compatibility with daylight, bi-color, and full-color lights
- Premium Glass Lens Design
- Minimized Stray Light
- Ideal for Precise Light Shaping
- Enhanced Efficiency with LiteFlow System

DL5 Parallel Booster



DL5 Parallel Booster



Honeycomb and Light Shield Ring for Precision Lighting



Enhanced Efficiency with LiteFlow System



GF14/FLS8/FLS10

FLS8+LB-01

FLS8 is compatible with the majority of Godox Bowens Mount LED lights.

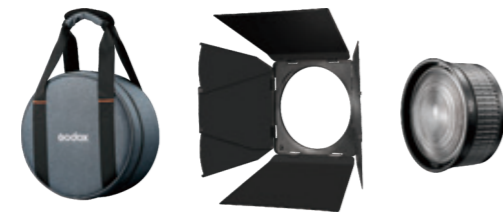

FLS10+LB-02

FLS10 is compatible with all Godox Bowens Mount LED lights.

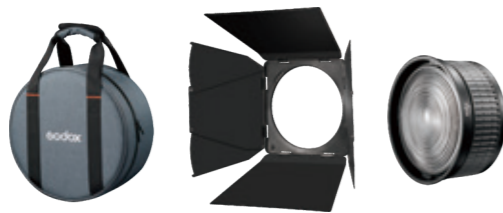

GF14+GF14B

GF14 is compatible with Godox G-Mount LED lights, such as MG1200Bi.

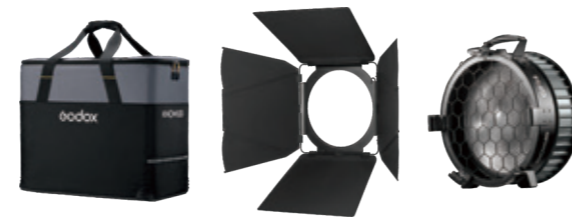

Tech Specs

Mode	FLS8	FLS10	GF14
Adjustable Beam Angle	10°-40°	10°-35°	15°-45°
Working Temperature	-10°C~40°C	-10°C~40°C	-10°C~40°C
Dimension	246*246*121mm	295*295*135mm	471*426*235mm
Weight	2kg	3kg	9.68kg

CS-50D/65D/85D

- Extremely fast setup
- Stunning, soft, omni-directional light
- Bowens Mount for compatibility
- Optional skirts for beam spread control





SF6090/SF4560 Kit

- Two versions to meet various size needs.
- Easy to store and transport with the carry case.
- Compact and foldable, making setup and usage easy.
- The black nets and one-stop silk can be used to adjust the contrast.
- The black solid fabric can be used to block unwanted illumination or create shadows.
- The two-stop silk can be used to diffuse and soften the light.
- The dots and fingers in black net and solid fabrics allow for shaping light on smaller objects or areas. Ideal for tabletop shooting or situations where larger fabrics are inconvenient.
- The open-edge design provides a softer cut of light and prevents hard transitions due to the edge.
- By finely adjusting the angle of the screen in front of the light, it allows for very changeable light and dark contrast, creating the desired transition.

Bowens Mount Quick Release Parabolic Softbox | QR-P70/P90/P120



QR-P70/P90/P120

- Reflective silver interior to render a punchy high contrast
- Removable inner and front fabric diffusers
- Impressive quick release system for rapid setup and breakdown
- Reliable light quality and various creative expressions
- Bowens mount strobes and continuous light compatible



Effortless Setup



Quick Breakdown

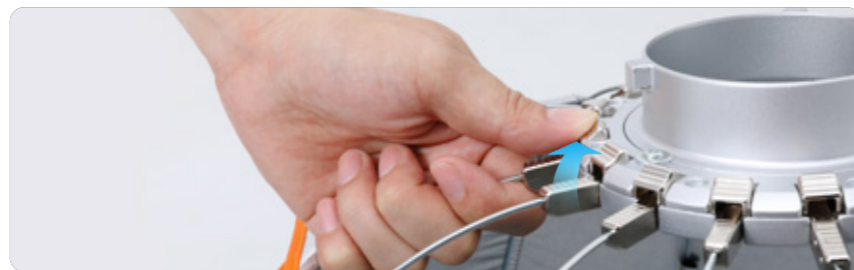

Bowens Mount | Softbox



Square Softbox



Rectangular Softbox



Strip Softbox



Octagon Softbox



Square Softbox with Grid



Rectangular Softbox with Grid



Strip Softbox with Grid



Octagon Softbox with Grid

SPECS

	Square Softbox	Rectangular Softbox	Strip Softbox	Octagon Softbox
Model	SB-BW-6060/9090	SB-BW-6090/70100/80120	SB-FW-50130/35160	SB-FW-95/120/140
Size	60x60cm(23.6"x23.6") 90x90cm(35.4"x35.4")	60x90cm(23.6"x35.4")/70x100cm(27.6"x39.4") 80x120cm(31.5"x47.2")	50x130cm(23.6"x51.2") 35x160cm(13.8"x 63.0")	φ95cm(37.4")/φ120cm(47.2") φ140cm(55.1")

Lighting Stands & Mountings

SA5015

Heavy Duty Steel Roller Stand

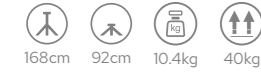

SA5045

Heavy Duty Steel Roller Stand

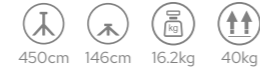

240CS

C-Stand with Arm (Silver)



270CS

C-Stand with Arm (Silver)

