

合格证  
QC PASS



Godox Audio Wechat  
Official Account  
神牛影音微信公众号



Overseas Official  
Accounts & Updates  
海外社媒平台及资讯

#### 深圳市神牛摄影器材有限公司

地址: 深圳市宝安区福海街道塘尾社区福川工业区厂房2栋 电话: 0755-29609320  
(8062) 传真: 0755-25723423 邮箱: godox@godox.com

#### GODOX Photo Equipment Co., Ltd.

Add.: Building 2, Yaochuan Industrial Zone, Tangwei Community, Fuhai Street, Bao'an  
District, Shenzhen 518103, China Tel: +86-755-29609320(8062)  
Fax: +86-755-25723423 E-mail: godox@godox.com

[www.godox.com](http://www.godox.com)

Made in China | 705-WECSK2-00



# Godox

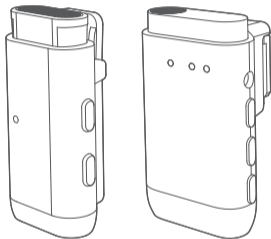

## WEC-S Kit1/WEC-S Kit2

无线领夹麦克风系统

Wireless Lavalier Microphone System

使用手册

Instruction Manual

## 前言

感谢购买神牛产品！

欢迎使用神牛相机版无线领夹麦克风系统WEC-S Kit1和WEC-S Kit2套装。本产品体积小、续航长，利用2.4GHz波段传输音频信号，适用于利用索尼相机的直播、采访、亲子教学、短视频、户外拍摄等多种场景。

使用本产品之前，请仔细阅读说明书，以便正确操作及使用。

## 主要特点：

- 全球通用频段2.4GHz无线技术；
- 无线距离最远可达200米（视距）；
- 无损音质，一键降噪；
- 输出音量调节，单声道/立体声自由切换；
- 支持数字/模拟两种音频模式；
- 接收器可做麦克风单独收音；
- 内置锂电池支持USB-C/充电盒充电；

## 警告

- △ 麦克风是精密设备。请勿使其掉落或受到撞击，以避免发生故障。
- △ 请勿私自拆卸、改装或尝试维修本产品。产品如出现故障须由本公司或授权的维修人员进行检查维修。
- △ 请保持干燥，请勿用湿手握持本产品，亦不可将产品浸入水中或暴露于雨中。
- △ 请勿将本产品存放在阳光直射的地方、加热装置附近或者炎热、潮湿或多尘的地方。
- △ 请勿让儿童接触本产品，以避免发生意外。
- △ 请勿在易燃易爆环境中使用。在这些场合下，请注意相关警告标识。
- △ 请勿放置在超过50度的高温环境中。
- △ 请仔细阅读并遵守由厂商提供的警告或指示。

## 产品结构

### 发射器

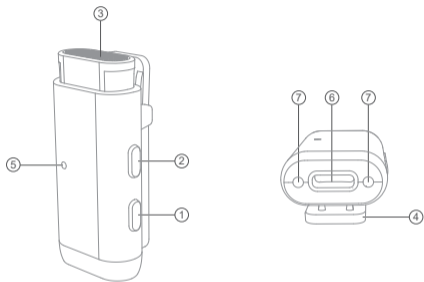

1. 电源键
2. 配对/降噪键
3. 内置麦克风
4. 背夹
5. 指示灯
6. USB-C充电口
7. 充电触点

03

### 接收器

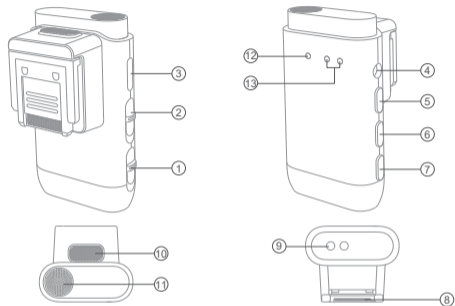

1. 数字/模拟音频切换键
2. 接收器麦克风开关键
3. USB-C接口
4. 3.5mm音频输出接口
5. 电源键
6. 配对/音量+键
7. 模式/音量-键
8. 热靴
9. 充电触点
10. 热靴拆卸键
11. 内置麦克风
12. 热靴连接指示灯
13. 配对指示灯

04

## 充电盒

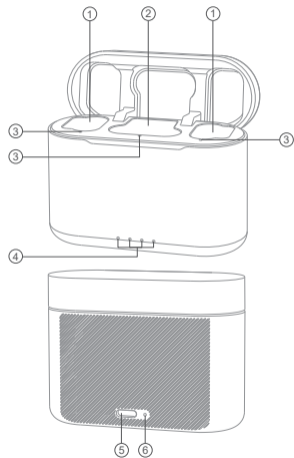

1. 发射器凹槽
2. 接收器凹槽
3. 盒内状态指示灯
4. 充电盒电量指示灯
5. USB-C 充电口
6. 复位孔

05

## 包装清单

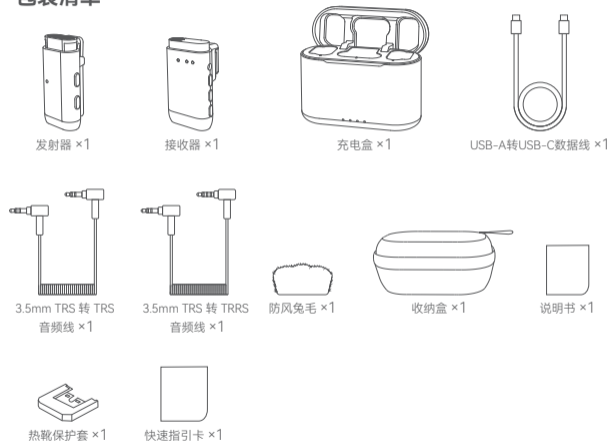

06

名称	型号	标配物品
无线领夹麦克风系统	WEC-S Kit1	发射器×1、接收器×1、USB-A转USB-C数据线×1、防风兔毛×2、3.5mm TRS转TRS音频线×1、3.5mm TRS转TRRS音频线×1、收纳盒×1、热靴保护套×1、说明书×1、快速指引卡×1
无线领夹麦克风系统	WEC-S Kit2	发射器×2、接收器×1、充电盒×1、USB-A转USB-C数据线×1、防风兔毛×3、3.5mm TRS转TRS音频线×1、3.5mm TRS转TRRS音频线×1、收纳盒×1、说明书×1、快速指引卡×1

温馨提示：说明书中的图片均为示意图，仅供参考。由于产品不断更新与升级，产品实物与图片可能存在差异，请以实物为准。

## 使用说明

### 1. 开关机

#### 1.1 操作说明

长按发射器和接收器的电源键<  >3s可实现开/关机。将机器从充电盒取出，自动开机；放入充电盒，则会自动关机。



注：若发射器和接收器开机后超过5分钟未配对成功，会自动关机。

#### 1.2 指示灯说明

指示灯状态	意义
发射器绿色闪烁（亮0.5s/灭0.5s）	开机未配对
接收器两个指示灯绿色闪烁（亮0.5s/灭0.5s）	开机未配对

### 2. 配对

#### 2.1 操作说明

长按发射器的配对/降噪键<  / DNR >以及接收器的配对/音量+键<  / + >2s进入配对状态，连接成功退出配对状态，未连接成功10s后退出配对状态。

#### 2.2 指示灯说明

指示灯状态	意义
发射器绿色快闪（亮0.25s/灭0.25s）	正在配对
发射器绿色长亮	配对成功

接收器两个指示灯绿色快闪（亮0.25s/灭0.25s）	正在配对
接收器TX1绿色长亮；TX2熄灭	一个发射器与接收器配对成功
接收器两个指示灯绿色长亮	两个发射器与接收器配对成功

注：两个发射器与接收器配对成功后，如果其中一个发射机关机，对应的TX1/TX2指示灯会在30秒后熄灭。

### 3. 降噪

#### 3.1 操作说明

短按发射器的配对/降噪键<  / DNR >可开启或关闭降噪功能。一拖二状态下一个发射器打开降噪功能，另外一个发射器也会同步打开，关闭亦同理。

#### 3.2 指示灯说明

指示灯状态	意义
发射器橙色长亮	开启降噪

### 4. 单声道/立体声模式切换

#### 4.1 操作说明

默认为单声道模式，长按接收器的模式/音量-键< M/- >5s可切换为立体声模式。

#### 4.2 指示灯说明

指示灯状态	意义
接收器绿色长亮	单声道模式
接收器蓝色长亮	立体声模式

### 5. 输出音量调节

短按接收器的配对/音量+键<  /+ >或模式/音量-键< M/- >可按高中低三个档位调节输出音量，首次开机默认音量中间档位。

## 6. 数字/模拟音频切换

滑动数字/模拟音频切换键< **DIGITAL ANALOG** >，可切换至数字音频或模拟音频模式。

“DIGITAL”表示数字音频，“ANALOG”表示模拟音频。

注：请勿在录制过程中切换，以免录音音频出现问题。

## 7. 接收器单独收音

滑动接收器麦克风开关键< **RX MIC** >，开启或关闭接收器麦克风，开启后接收器可单独收音。

## 8. 充电

### 8.1 USB-C充电

将发射器和接收器通过USB-A转USB-C数据线连接电源即可为产品充电。

指示灯状态	意义
发射器和接收器白色闪烁	充电中
发射器和接收器白色长亮	充满电
发射器红色闪烁（亮0.5s/灭0.5s）	发射器电量低于10%
接收器TX1红色长亮；TX2显示正常	接收器未低电量，TX1低电量，TX2未低电量
接收器TX1显示正常；TX2红色长亮	接收器未低电量，TX1未低电量，TX2低电量
接收器TX1/TX2红色长亮	接收器未低电量，TX1低电量，TX2低电量
接收器TX1/TX2红色闪烁（亮0.5s/灭0.5s）	接收器低电量

## 8.2 充电盒充电

将发射器/接收器放入充电盒内充电时，首先会检测发射器/接收器是否插入对应凹槽内，顶针接触到充电触点后，盒内对应的状态指示灯会亮起，然后检测发射器/接收器是否为满电状态，如果不满电则开始充电直至充满。开盖后，盒内状态指示灯与充电盒电量指示灯会同时亮起，分别显示盒内发射器/接收器与充电盒自身的电量状态。

充电盒自身充电时四个充电盒电量指示灯递增式白色闪烁，充满后保持长亮。

指示灯状态	意义
盒内状态指示灯白色闪烁	发射器/接收器充电中
盒内状态指示灯白色长亮	发射器/接收器充满电
四个充电盒电量指示灯白色长亮	充电盒电量100%
开盖后从左往右前三个充电盒电量指示灯白色长亮，最后一个熄灭	充电盒电量75%
开盖后从左往右前两个充电盒电量指示灯白色长亮，后两个熄灭	充电盒电量50%
开盖后从左往右第一个充电盒电量指示灯白色长亮，后三个熄灭	充电盒电量25%
开盖后从左往右第一个充电盒电量指示灯白色闪烁，后三个熄灭	充电盒电量低，请及时充电
开盖后四个充电盒电量指示灯全部熄灭	充电盒电量0%，自动关机

## 安装说明

将发射器利用背夹佩戴在衣领处。

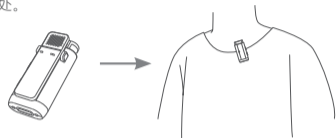

接收器可通过热靴直接连接索尼相机，连接成功后热靴连接指示灯会亮起。拆卸时只需按下热靴拆卸键，然后拔出接收器即可。

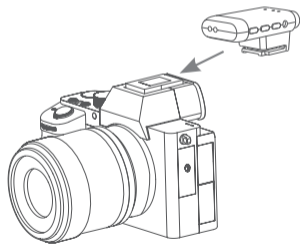



或通过3.5mm TRS转TRRS音频线连接接收器的3.5mm音频输出接口与手机的3.5mm耳机孔，亦可搭配手机使用。

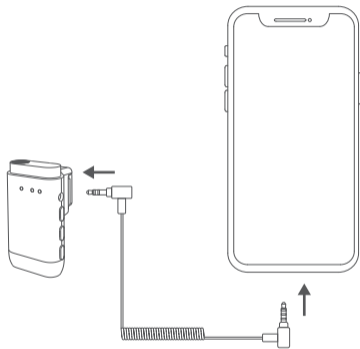

## 规格参数

名称	发射器	接收器	充电盒
型号	WEC TX	WEC SRX	WEC-CS
传输类型	2.4GHz数字跳频系统	2.4GHz数字跳频系统	/
拾音模式	全向型	/	/
频率范围	20Hz-20KHz	/	/
最大SPL	110dB	/	/
动态范围	86dB	/	/
最大无线距离	200米（视距）		/
锂电池参数	3.7V = 140mAh, 0.518Wh	3.8V = 200mAh, 0.76Wh	3.7V = 1400mAh, 5.18Wh
USB-C输入	5V = 160mA	5V = 200mA	5V = 1.3A
续航时间	约8小时	约8小时	大约可为三台机器充电两次
充电时间	约2小时	约2小时	约2小时

工作环境温度	-10~50°C	-10~50°C	-10~50°C
尺寸	48mm×22mm×16mm	52mm x 24mm x 30mm	63mm×85mm×36mm
净重≈	12g	19g	87g

规格参数如有变更，恕不另行通知。

## 维护保养

**避免跌落：**如果受到强烈碰撞或振动，设备可能会发生故障。

**保持干燥：**本产品是非防水产品，如果将其浸入水中或放置于高湿度的环境中将可能发生故障。内部构造生锈可能会导致无法修理的损害。

**避免温度骤变：**温度的突变，诸如在寒冷天进出温暖的大楼将可能会使产品内部结露。为避免结露，请将本产品事先装入手提袋或塑料包内，以防温度突变。

**远离强磁场：**无线电广播发射机等设备产生的强静电或强磁场可能会干扰本产品正常工作。

如有技术更改，恕不另行通知。

## Foreword

Thank you for purchasing!

WEC-S Kit1 and WEC-S Kit2 are the latest wireless lavalier microphone systems designed for Sony cameras. With the characteristics of compact and portable, long duration of use, as well as 2.4GHz wireless transmission, it's quite suitable for live streaming, interview, family lecturing, short video recording, outdoor shooting, etc.

Please read this manual carefully before using to make sure the correct operation and exert the optimum function.

## Main Feature

- Globally universal 2.4GHz wireless transmission technology.
- The maximum wireless transmission distance up to 200m (sight distance).
- Clear and stable sound quality with denoise function.
- Output volume adjustment and switchable mono/stereo mode.
- Support digital and analog audio mode.
- Receiver is workable as an individual microphone.
- Built-in lithium battery support charging through USB-C cable or charging case.

## Warning

- ⚠ This product is high-precision instrument, please avoid falling, collision or pounding.
- ⚠ Do not disassemble. Should repairs become necessary, this product must be sent to our Company or an authorized maintenance center.
- ⚠ Always keep this product dry. Do not use in rain or damp conditions.
- ⚠ Do not leave or store this product in the environment of direct sunlight, near heating devices, or in hot, humid or dusty.
- ⚠ Keep out of reach of children.
- ⚠ Do not use in flammable and explosive environments. Pay attention to the relevant warning signs.
- ⚠ Do not leave or store the product if the ambient temperature reads over 50°C.
- ⚠ Please read carefully and follow the warnings or instructions provided by the manufacturer.

## Structure of Product

### Transmitter

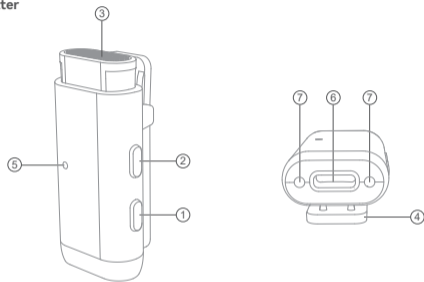

1. Power Switch Button
2. Pairing/Denoise Button
3. Built-in Microphone
4. Back Clip

5. Indicator
6. USB-C Charging Port
7. Charging Points

## Receiver

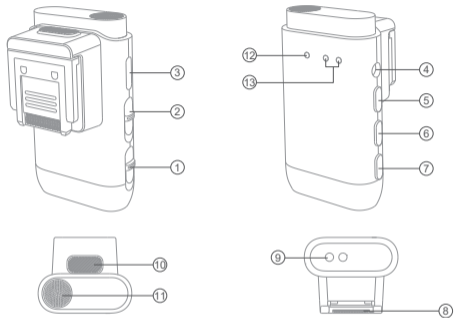

- |  |                            |                                   |
|--|----------------------------|-----------------------------------|
| 1. Digital/Analog Audio Mode Switch Button | 6. Pairing/Volume + Button | 10. Hot Shoe Detaching Button     |
| 2. Receiver's Mic Switch Button            | 7. Mode/ Volume - Button   | 11. Built-in Microphone           |
| 3. USB-C Port                              | 8. Hot Shoe                | 12. Hot Shoe Connecting Indicator |
| 4. 3.5mm Audio Output Port                 | 9. Charging Points         | 13. Pairing Indicator             |

21

## Charging Case

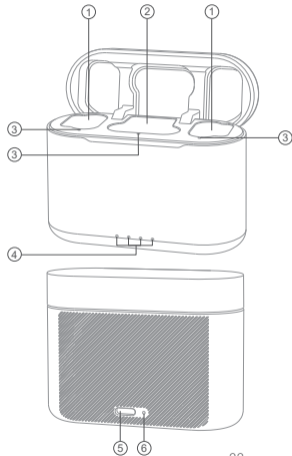

1. Transmitter's Slot
2. Receiver's Slot
3. Internal Status Indicator
4. External Charging Indicator
5. USB-C Charging Port
6. Reset Hole

22

## What's Inside



Transmitter ×1



Receiver ×1



Charging Case ×1



USB-A to USB-C Data Cable ×1

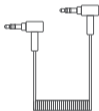

3.5mm TRS-TRS Audio Cable ×1

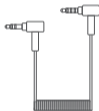

3.5mm TRS-TRRS Audio Cable ×1



Furry Windscreen ×1



Storage Box ×1



Instruction Manual ×1



Hot Shoe Cover ×1



Quick Start Guide ×1

Product Name	Model	Package List
Wireless Lavalier Microphone System	WEC-S Kit1	Transmitter ×1, Receiver ×1, USB-A to USB-C Data Cable ×1, Furry Windscreen ×2, 3.5mm TRS-TRS Audio Cable ×1, 3.5mm TRS-TRRS Audio Cable ×1, Storage Box ×1, Hot Shoe Cover ×1, Instruction Manual ×1, Quick Start Guide ×1
Wireless Lavalier Microphone System	WEC-S Kit2	Transmitter ×2, Receiver ×1, Charging Case ×1, USB-A to USB-C Data Cable ×1, Furry Windscreen ×3, 3.5mm TRS-TRS Audio Cable ×1, 3.5mm TRS-TRRS Audio Cable ×1, Storage Box ×1, Instruction Manual ×1, Quick Start Guide ×1

Note: Due to continuous updates and upgrades of the products, there may be differences between the actual products and the pictures. Therefore, the pictures are for reference only, products to prevail in kind.

## Instructions for Use

### 1. Power Switch

#### 1.1 Operating Instructions

Press and hold the power switch button <  > for 3s to turn on or off the transmitter and receiver. Take out the devices from the charging case, they will boot up automatically, while put them into the charging case, they will be turned off.



Note: The transmitter and receiver will be turned off if they stay unpaired in 5min after powered on.

#### 1.2 Indicator Instructions

Indicator Status	Meaning
Indicator of transmitter flashes green every 0.5s	Unpaired after powered on
Both indicators of receiver flash green every 0.5s	Unpaired after powered on

### 2. Pairing

#### 2.1 Operating Instructions

Press and hold the pairing/denoise button <  / DNR > of transmitter and pairing/volume + button <  / + > of receiver for 2s to pairing them. They will exit pairing status once paired, while exit after 10s if unpaired.

#### 2.2 Indicator Instructions

Indicator Status	Meaning
Indicator of transmitter flashes green rapidly every 0.25s	Pairing status
Indicator of transmitter is constant on green	Paired
Both indicators of receiver flash green rapidly every 0.25s	Pairing status
TX1 indicator of receiver is constant on green, TX2 indicator of receiver is off	One transmitter and one receiver are paired
Both indicators of receiver are constant on green	Two transmitters and one receiver are paired

Note: If two transmitters are paired with the receiver but one of which is turned off later, then its corresponding TX1/TX2 indicator will be off in 30s.

### 3. Denoise

#### 3.1 Operating Instructions

Press the pairing/denoise button <  / DNR > of transmitter to turn on or off the denoise function. When the denoise function of one transmitter in WEC-S Kit2 is turned on, the other transmitter will be turned on simultaneously, and the same applies when the denoise function is turned off.

#### 3.2 Indicator Instructions

Indicator Status	Meaning
Indicator of transmitter is constant on orange	Denoise function is on

### 4. Mono/Stereo Mode Switch

#### 4.1 Operating Instructions

The sound track mode is mono by default, press and hold the mode/volume – button < **M / –** > of receiver for 5s can switch to stereo mode.

#### 4.2 Indicator Instructions

Indicator Status	Meaning
Both indicators of receiver are constant on green	Mono mode
Both indicators of receiver are constant on blue	Stereo mode

### 5. Output Volume Adjustment

Press and hold the pairing/volume + button <  / + > or mode/volume – button < **M / –** > of receiver can adjust the output volume in 3 levels (high, medium and low). The volume is the medium level by default after first boot.

### 6. Digital/Analog Audio Mode Switch

Slide the digital/analog audio mode switch button < **DIGITAL ANALOG** > can switch to digital audio mode or analog audio mode.

Note: Please do not switch during recording to avoid problems with the recorded audio.

### 7. Receiver's Mic

Slide the receiver's mic switch button < **RX MIC** > to turn on or turn off the receiver's mic, the receiver is workable as a microphone to record individually when it's turned on.

## 8. Charging

### 8.1 Charging through USB-A to USB-C Cable

The transmitter and receiver can be charged after connecting to power source through USB-A to USB-C cable.

Indicator Status	Meaning
Indicators of transmitter and receiver flash white	Charging
Indicators of transmitter and receiver are constant on white	Fully charged
Indicator of transmitter flashes red every 0.5s	Battery level of transmitter is below 10%
TX1 indicator of receiver is constant on red, TX2 indicator of receiver displays normally	Battery levels of receiver and transmitter TX2 are normal, while battery level of transmitter TX1 is below 10%

TX1 indicator of receiver displays normally, TX2 indicator of receiver is constant on red	Battery levels of receiver and transmitter TX1 are normal, while battery level of transmitter TX2 is below 10%
TX1 and TX2 indicators of receiver are constant on red	Battery level of receiver is normal, while battery levels of transmitter TX1 and TX2 are below 10%
TX1 and TX2 indicators of receiver flash red every 0.5s	Battery level of receiver is below 10%

### 8.2 Charging Through Charging Case

Put the transmitter/receiver into the charging case, the case will first detect whether the transmitter/receiver is correctly inserted into the corresponding slot, the corresponding internal status indicator will light up if the pins inside touched the charging points of the transmitter/receiver. Then it will detect whether the transmitter/receiver is fully charged, if not, it will start charging until it's fully charged. The internal status indicators and external charging indicators will light up at the same time to show the battery level of the transmitter/receiver and the charging case itself if the charging case lid is open.

When charging the case itself, the four external charging indicators will flash white incrementally, and be constant on white after the charging case is fully charged.



Indicator Status	Meaning
Internal status indicator flashes white	The transmitter/receiver being charged
Internal status indicator is constant on white	The transmitter/receiver is fully charged
Four external charging indicators are constant on white	Charging case battery level is 100%
The first three external charging indicators from left to right are constant on white after the lid is open, while the last one is off	Charging case battery level is 75%
The first two external charging indicators from left to right are constant on white after the lid is open, while the other two are off	Charging case battery level is 50%
The first external charging indicator from left to right is constant on white after the lid is open, while the last three are off	Charging case battery level is 25%
The first external charging indicator from left to right flashes white after the lid is open, while the last three are off	Charging case battery level is low, please charge in time
Four charging indicators are all off after the lid is open	Charging case battery level is 0%, it will automatically turn off

## Instructions for Installation

Clip the transmitter to the collar with its back clip.

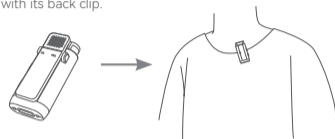

Clip the receiver to Sony camera directly through the hot shoe, the hot shoe connecting indicator will light up after connection. Push the hot shoe detaching button and pull out the receiver to detach it from the camera.

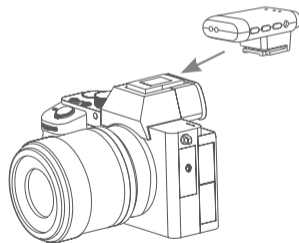

Connect the 3.5mm audio output port of receiver to the 3.5mm earphone jack port of smartphone with the 3.5mm TRS-TRRS audio cable.

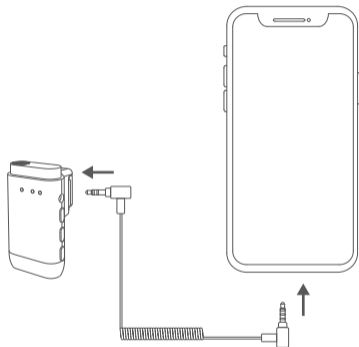

## Technical Data

Name	Transmitter	Receiver	Charging Case
Model	WEC TX	WEC SRX	WEC-CS
Transmission Type	2.4GHz Frequency Hopping System	2.4GHz Frequency Hopping System	/
Pickup Pattern	Omnidirectional	/	/
Frequency Range	20Hz-20KHz	/	/
Max. SPL	110dB	/	/
Dynamic Range	86dB	/	/
Max. Wireless Distance	200m (sight distance)		/
Lithium Battery Parameters	3.7V = 140mAh, 0.518Wh	3.8V = 200mAh, 0.76Wh	3.7V = 1400mAh, 5.18Wh
USB-C Input	5V = 160mA	5V = 200mA	5V = 1.3A
Working Time	Approx. 8h	Approx. 8h	Charge 3 devices for about twice

Charging Time	Approx. 2h	Approx. 2h	Approx. 2h
Working Environment Temperature	-10~50°C	-10~50°C	-10~50°C
Dimension	1.89"×0.87"×0.63"	2.05"×0.94"×1.18"	2.48"×3.35"×1.42"
Net Weight≈	12g	19g	87g

Specifications and data may subject to changes without notice.

## Maintenance

**Avoid falling.** Strong collision or vibration may malfunction the device.

**Keep dry.** This product is not water-proof. Malfunction, rust, and corrosion may occur and go beyond repair if soaked in water or exposed to high humidity.

**Avoid sudden temperature changes.** Condensation happens in sudden temperature changes such as the circumstance when taking the product out of a building with higher temperature to outside in winter. Please put the product in a handbag or plastic bag beforehand.

**Keep away from strong magnetic field.** The strong static or magnetic field produced by devices such as radio transmitters leads to malfunction.

Specifications and data may subject to changes without notice.

## FCC Statement

This device complies with part 15 of the FCC Rules. Operation is subject to the following two conditions:

- (1) This device may not cause harmful interference, and
- (2) this device must accept any interference received, including interference that may cause undesired operation.

Any Changes or modifications not expressly approved by the party responsible for compliance could void the user's authority to operate the equipment.

Note: This equipment has been tested and found to comply with the limits for a Class B digital device, pursuant to part 15 of the FCC Rules. These limits are designed to provide reasonable protection against harmful interference in a residential installation. This equipment generates uses and can radiate radio frequency energy and, if not installed and used in accordance with the instructions, may cause harmful interference to radio communications. However, there is no guarantee that interference will not occur in a particular installation. If this equipment does cause harmful interference to radio or television reception, which can be determined by turning the equipment off and on, the user is encouraged to try to correct the interference by one or more of the following measures:

- Reorient or relocate the receiving antenna.
- Increase the separation between the equipment and receiver.
- Connect the equipment into an outlet on a circuit different from that to which the receiver is connected.
- Consult the dealer or an experienced radio/TV technician for help.

The device has been evaluated to meet general RF exposure requirement.

The device can be used in portable exposure condition without restriction.

## Warning

Operating frequency: 2402MHz – 2480MHz (WEC TX/WEC SRX)

Maximum EIRP Power: 0.73dBm (WEC TX)/ -7.69dBm (WEC SRX)

## Declaration of Conformity

GODOX Photo Equipment Co.,Ltd. hereby declares that this equipment are in compliance with the essential requirements and other relevant provisions of Directive 2014/53/EU. In accordance with Article 10(2) and Article 10(10), this product is allowed to be used in all EU member states.

For more information of DoC, Please click this web link:

<https://www.godox.com/eu-declaration-of-conformity>

The device complies with RF specifications when the device used at 0mm from your body.

## Marking Information



## 产品保修

尊敬的用户,本保修卡是申请保修服务的重要凭证,请您配合销售商填写并妥善保管,谢谢!

产品信息	型号	产品条码
用户信息	姓名	联系电话
	通信地址	
销售商信息	名称	
	联系电话	
	通信地址	
	销售日期	
备注		

注:此表应由销售商盖章确认。

### 产品信息

本文件适用于相关《产品保修信息》(见后面说明)所列产品,其他非属此范围的产品或部件(如促销品、赠品及其他出厂后附加的部件等)不在此保修承诺内。

### 保修期

产品及部件的相应保修期按相关的《产品保修信息》执行。保修期自产品首次购买日起算,购买日以购买产品时保修卡登记日期为准。

### 如何获得保修服务

要保修服务,您可直接与产品销售商或授权服务机构联系,也可拨打神牛产品售后服务电话,与我们联系,由我们的服务人员为您安排服务。申请保修时,您应提供有效的保修卡作为保修凭证,方可获得保修。如您不能提供有效的保修卡,则在我们可确认产品或部件属于保修范围的情况下,也可以为您提供保修,但这不作为我们的义务。

### 不适用保修的情况

如产品存在下列情况,本文件项下的保证和服务将不适用 ① 产品或部件超过相应保修期; ② 错误或不适当使用、维护或保管导致的故障或损坏,如:不当搬运;非按产品合理预期用途使用;不当插拔外接设备;跌落或外力挤压;接触或暴露于不适当温度、溶剂、酸碱、水浸或潮湿环境; ③ 由非神牛授权机构或人员安装、修理、更改、添加或拆卸造成的故障或损坏; ④ 产品或部件原有识别信息被修改变更或删除; ⑤ 无有效保修卡; ⑥ 使用非合法授权、非标准或非公开发行的软件造成的故障或损坏; ⑦ 因不可抗力或意外事件造成的故障或损坏; ⑧ 其他非因产品本身质量问题导致的故障或损坏。遇上述情况,您应向相关责任方寻求解决,神牛对此不承担任何责任。因非在保修期或保修范围内的部件、附件或软件导致产品不能正常使用的,不是保修范围内的故障。产品使用过程中正常的脱色、磨损和消耗,不是保修范围内的故障。

## 产品保修和服务支持信息

产品的保修期和服务类型按以下《产品保修信息》执行：

产品类别	选件名称	保修期(月)	保修服务类型
部件	电路板	12	客户送修
	电池	3	客户送修
	充电器等带电性能的部件	12	客户送修
其他	如电池盒、防风棉、防风毛罩、锁紧装置、手提绳、扎带、魔术贴、领夹、便携袋、包装等	无	无保修

神牛产品售后服务电话 0755-29609320-8062

## Warranty

Dear customers, as this warranty card is an important certificate to apply for our maintenance service, please fill in the following form in coordination with the seller and safe-keep it. Thank you!

Product Information	Model	Product Code Number
Customer Information	Name	Contact Number
	Address	
Seller Information	Name	
	Contact Number	
	Address	
	Date of Sale	
Note		

Note: This form shall be sealed by the seller.

### Applicable Products

The document applies to the products listed on the Product Maintenance Information (see below for further information). Other products or accessories (e.g. promotional items, giveaways and additional accessories attached, etc.) are not included in this warranty scope.

### Warranty Period

The warranty period of products and accessories is implemented according to the relevant Product Maintenance Information. The warranty period is calculated from the day (purchase date) when the product is bought for the first time, and the purchase date is considered as the date registered on the warranty card when buying the product.

### How to Get the Maintenance Service

If maintenance service is needed, you can directly contact the product distributor or authorized service institutions. You can also contact the Godox after-sale service call and we will offer you service. When applying for maintenance service, you should provide valid warranty card. If you cannot provide valid warranty card, we may offer you maintenance service once confirmed that the product or accessory is involved in the maintenance scope, but that shall not be considered as our obligation.

### Inapplicable Cases

The guarantee and service offered by this document are not applicable in the following cases: ①. The product or accessory has expired its warranty period; ②. Breakage or damage caused by inappropriate usage, maintenance or preservation, such as improper packing, improper usage, improper plugging in/out external equipment, falling off or squeezing by external force, contacting or exposing to the improper temperature, solvent, acid, base, flooding and damp environments, etc; ③. Breakage or damage caused by non-authorized institution or staff in the process of installation, maintenance, alternation, addition and detachment; ④. The original identifying information of product or accessory is modified, alternated, or removed; ⑤. No valid warranty card; ⑥. Breakage or damage caused by using illegally authorized, nonstandard or non-public released software; ⑦. Breakage or damage caused by force majeure or accident; ⑧. Breakage or damage that could not be attributed to

**the product itself.** Once met these situations above, you should seek solutions from the related responsible parties and Godox assumes no responsibility. The damage caused by parts, accessories and software that beyond the warranty period or scope is not included in our maintenance scope. The normal discoloration, abrasion and consumption are not the breakage within the maintenance scope.

### Maintenance and Service Support Information

The warranty period and service types of products are implemented according to the following Product Maintenance Information:

Product Type	Name	Maintenance Period(month)	Warranty Service Type
Parts	Product Main Body	12	Customer sends the product to designated site
	Battery	3	Customer sends the product to designated site
	Charger, Electrical Parts etc.	12	Customer sends the product to designated site
Other Items	Battery Case, Windscreen Foam, Wind Cap, Locking Device, Lanyard, Tie, Velcro Tape, Clip, Bag, Package etc.	No	Without warranty

Godox After-sale Service Call 0755-29609320-8062