

合格证
QC PASS

Godox

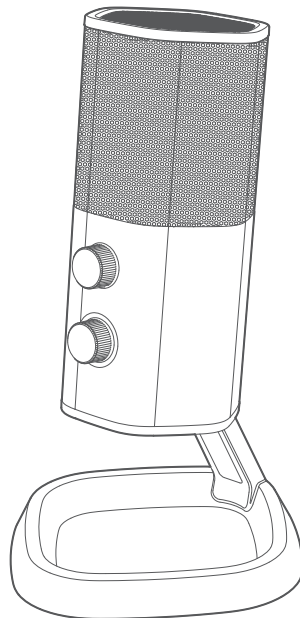

Godox Audio Wechat
Official Account
神牛影音微信公众号



Overseas Official
Accounts & Updates
海外社媒平台及资讯

深圳市神牛摄影器材有限公司

地址: 深圳市宝安区福海街道塘尾社区耀川工业区厂房2栋 电话: 0755-29609320
(8062) 传真: 0755-25723423 邮箱: godox@godox.com

GODOX Photo Equipment Co., Ltd.

Add.: Building 2, Yaochuan Industrial Zone, Tangwei Community, Fuhai Street, Bao'an District, Shenzhen 518103, China Tel: +86-755-29609320(8062)
Fax: +86-755-25723423 E-mail: godox@godox.com

www.godox.com

Made in China | 705-UMYC22-00



UMic22

2.4GHz双模桌面麦克风

2.4GHz Dual-Pattern USB Condenser Microphone

使用手册
Instruction Manual

前言

感谢购买神牛产品!

UMic22是一款增加2.4GHz模块的双指向桌面麦克风, 心型指向拾取麦克风正前方声音, 全指向则拾取麦克风四周声音。开启2.4GHz时, 它将以无线传输方式传输音频信号, 可与MoveLink II接收器配对使用, 适用于多人会议/博客/户外/亲子游戏等, 轻松实现一机多场景使用。

使用本产品之前, 请仔细阅读说明书, 以便正确操作及使用。

主要特点:

- 全球通用2.4GHz无线频段;
- 指向性/静音旋钮可切换心型指向、全指向、静音模式;
- 增益旋钮可调节范围1-10档;
- 音量/配对旋钮可调节范围1-10档;
- 长按音量/配对旋钮3秒即可进入配对状态;
- 内置锂电池可通过USB-C接口充电;
- 3.5mm耳机孔支持实时监听;
- 3/8" 螺纹接口可安装各类悬臂支架;

警告

- △ 麦克风是精密设备。请勿使其掉落或受到撞击, 以避免发生故障。
- △ 请勿私自拆卸、改装或尝试维修本产品。产品如出现故障须由本公司或授权的维修人员进行检查维修。
- △ 请保持干燥, 请勿用湿手握持本产品, 亦不可将产品浸入水中或暴露于雨中。
- △ 请勿将本产品存放在阳光直射的地方、加热装置附近或者炎热、潮湿或多尘的地方。
- △ 请勿让儿童接触本产品, 以避免发生意外。
- △ 请勿在易燃易爆环境中使用。在这些场合下, 请注意相关警告标识。
- △ 请勿放置在超过50度的高温环境中。
- △ 请仔细阅读并遵守由厂商提供的警告或指示。

产品结构

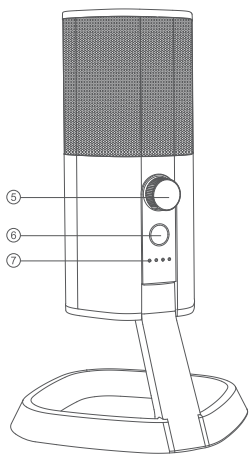
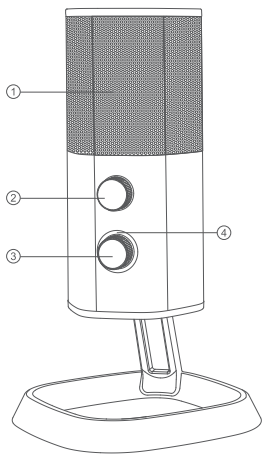

1. 麦克风
2. 增益旋钮
3. 指向性/静音旋钮
4. 工作指示灯
5. 音量/配对旋钮
6. 开关键
7. 电量指示灯
8. USB-C接口
9. 3/8" 螺纹接口
10. 3.5mm耳机监听孔

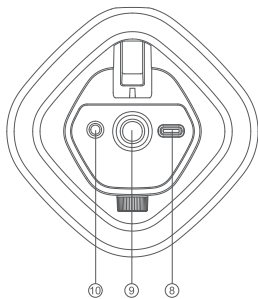

物料清单



麦克风 ×1

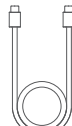

USB-C转USB-C数据线 ×1



USB-C 转 USB-A 转接头 ×1



说明书 ×1

温馨提示：说明书中的图片均为示意图，仅供参考。由于产品不断更新与升级，产品实物与图片可能存在差异，请以实物为准。

指示灯说明

1. 电量指示灯

开机后，满电状态下4盏指示灯长亮蓝色，然后根据剩余电量递减。电量只剩10%时最后一盏灯闪烁蓝色，闪烁频率0.5S一次。

充电时，4盏指示灯按递增方式闪烁蓝色，闪烁频率0.5S一次，充满电时4盏指示灯长亮蓝色。

2. 工作指示灯

麦克风正常开机工作时长亮蓝色，静音状态下长亮红色。

配对过程中为黄蓝闪烁，闪烁频率0.5S一次，配对成功后转为长亮绿色，配对失败转为长亮黄色。

开机后2.4GHz自动开启，工作指示灯长亮黄色。关机状态下通过USB-C数据线连接电源会自动开机（仅为充电模式），此时2.4GHz为关闭状态，工作指示灯长亮蓝色，需手动开机开启2.4GHz。

按键说明

1. 开机键

长按3秒开机，再按3秒关机。

2. 增益旋钮

向左旋转增益逐渐减小，向右旋转增益逐渐增大，增益调节范围1~10档。

3. 指向性/静音旋钮

向左旋转为心形指向，向右旋转为全指向，中间为静音模式。

4. 音量/配对旋钮

向左旋转耳机监听音量逐渐减小，向右旋转耳机监听音量逐渐增大，音量调节范围1~10档。长按3秒音量/配对旋钮，麦克风进入配对状态。

配对连接

UMic22内嵌2.4G发射机模块，可以与MoveLink II接收器配对使用。

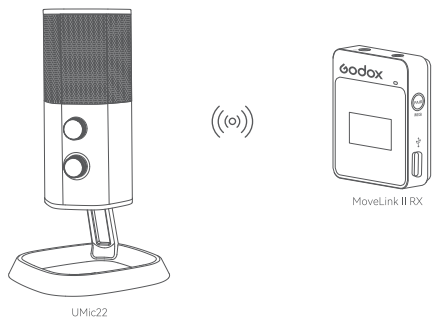

连接电脑

将USB-C数据线的的一端连接麦克风，另一端连接USB-C转USB-A转接头，再使用转接头插入电脑USB接口，电脑设置中输入设备选择：麦克风（UMic22）。

注：通过USB-C数据线连接电源后，麦克风默认进入充电模式。不开机状态下指示灯仍会显示充电状态的蓝色闪烁直至充满。

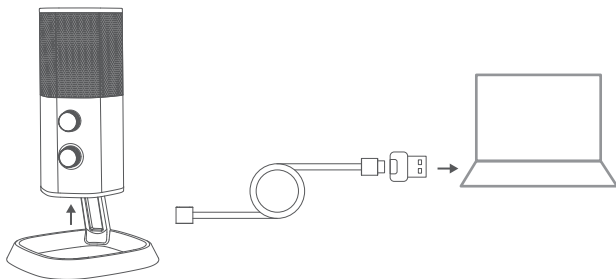

频率响应

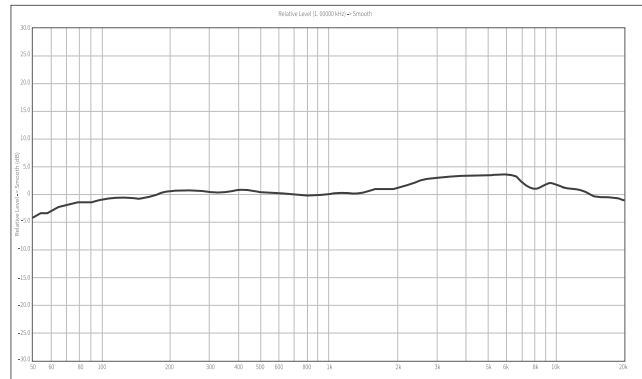

指向性图

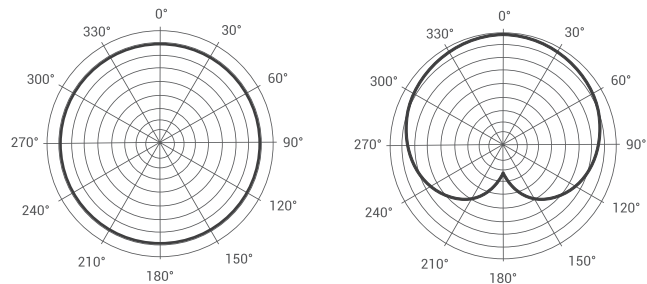

规格参数

型号	UMic22
拾音模式	心形、全指向
心形指向灵敏度	-36dB±3dB
全指向灵敏度	-36dB±3dB
输入参数	5V = 1A
锂电池参数	3.8V = 770mAh
频率响应	20Hz-20kHz
最大声压	120dB
信噪比	60-75dB
采样率	48kHz
音量调节范围	1-10档
增益调节范围	1-10档
续航时间	约25小时
2.4GHz射频范围	最大无线距离100米（与MoveLink II RX配对使用时）
工作环境温度	-10°C ~ +50°C
尺寸	57mm*171mm*104mm
净重	276g

规格参数如有变更，恕不另行通知。

维护保养

避免跌落：如果受到强烈碰撞或振动，设备可能会发生故障。

保持干燥：本产品是非防水产品，如果将其浸入水中或放置于高湿度的环境中将可能发生故障。内部构造生锈可能会导致无法修理的损害。

避免温度骤变：温度的突变，诸如在寒冷天进出温暖的大楼将可能会使产品内部结露。为避免结露，请将本产品事先装入手提袋或塑料包内，以防温度突变。

远离强磁场：无线电广播发射机等设备产生的强静电或强磁场可能会干扰本产品正常工作。

Foreword

Thank you for purchasing!

With built-in 2.4GHz module, UMic22 is able to transmit wireless signal after paired with MoveLink II receiver. It has two pickup patterns, cardioid pattern precisely picks up the sound at front, while omnidirectional pattern picks up the sound all around. Suitable for multi-party conference, blogs, outdoor activities, family games, etc, this microphone can truly achieve multi-scenario using. Please read this manual carefully before using to make sure the correct operation and exert the optimum function.

Main Features

- Globally accepted 2.4GHz wireless band.
- Directivity/mute dial switches among cardioid pattern, omnidirectional pattern or mute mode.
- Gain dial freely adjusts the gain from 1 to 10.
- Volume/pairing dial freely adjusts the volume from 1 to 10.
- Long press the volume/pairing dial for 3s to enter pairing status.
- Built-in lithium battery is chargeable via USB-C port.
- 3.5mm earphone jack supports real time monitoring.
- 3/8" threaded port is mountable onto various brackets.

Warning

- ⚠ Do not disassemble. Should repairs become necessary, this product must be sent to an authorized maintenance center.
- ⚠ Always keep this product dry. Do not use in rain or in damp conditions.
- ⚠ Keep out of reach of children.
- ⚠ Do not use the flash unit in the presence of flammable gas. In certain circumstance, please pay attention to the relevant warnings.
- ⚠ Do not leave or store the product if the ambient temperature reads over 50°C.
- ⚠ Read and understand all instructions before using.
- ⚠ Changes made to the specifications or designs may not be reflected in this manual.

Name of Parts

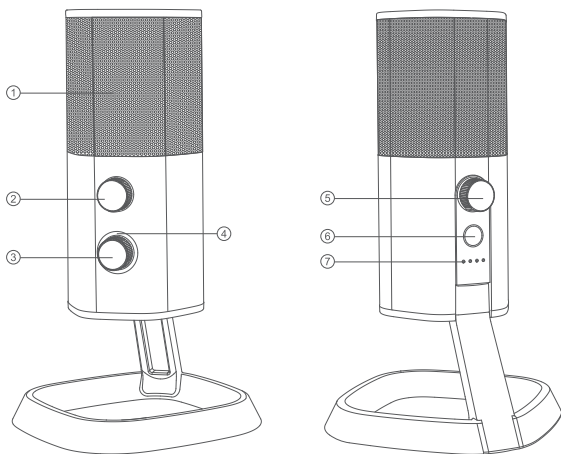

1. Microphone
2. Gain Dial
3. Directivity/Mute Dial
4. Working Indicator
5. Volume/Pairing Dial
6. Power Switch
7. Battery Level Indicator
8. USB-C Port
9. 3/8" Threaded Port
10. 3.5mm Earphone Jack

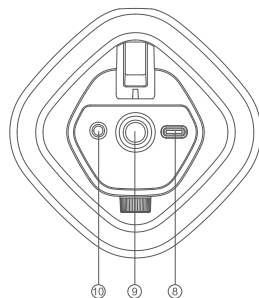

What's Inside

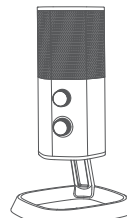

Microphone ×1

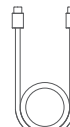

USB-C to USB-C Data Cable ×1



USB-C to USB-A Adapter ×1



Instruction Manual ×1

Note: Due to continuous updates and upgrades of the products, there may be differences between the actual products and the pictures. Therefore, the pictures are for reference only, products to prevail in kind.

Indicator Instruction

1. Battery Level Indicator

Turn on the microphone, the 4 indicators will be constant on blue in full battery level, then decrease according to the remaining battery level. When the battery level is below 10%, the last indicator will flash blue in every 0.5S.

When charging the microphone, the 4 indicators will flash blue incrementally in every 0.5S, and be constant on blue after fully charged.

2. Working Indicator

The indicator will be constant on blue when working normally, and red in mute mode.

The indicator will flash yellow and blue in every 0.5S when pairing, and be constant on green after successfully paired, while be constant on yellow if pairing failed.

The 2.4GHz will be automatically turned on after the microphone is powered on, and the working indicator will be constant on yellow. In power off status, it will automatically turn to charging mode when connected to a power source via USB-C cable. At this time, the 2.4GHz is turned off and the working indicator will be constant on blue, you need to turn on the microphone and 2.4GHz manually.

Button Instruction

1. Power Switch

Long press the power switch for 3s to turn on or off the microphone.

2. Gain Dial

The gain value is adjustable from 1 to 10, by turning the gain dial leftward to reduce while rightward to increase.

3. Directivity/Mute Dial

Turn the directivity/mute dial to the left, the microphone is cardioid pickup pattern. Turn it to the right, the microphone is omnidirectional pickup pattern. Turn it to the middle, the microphone is mute mode.

4. Volume/Pairing Dial

The volume is adjustable from 1 to 10, by turning the volume/pairing dial leftward to reduce while rightward to increase. Long press it for 3s to enter pairing status.

Pairing

This microphone has built-in 2.4GHz transmitting module, can be paired with 2.4GHz receiver MoveLink II RX.

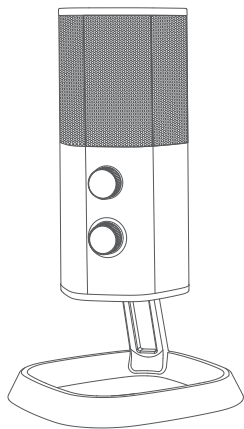

UMic22

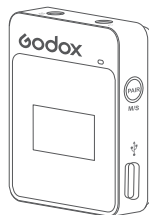

MoveLink II RX

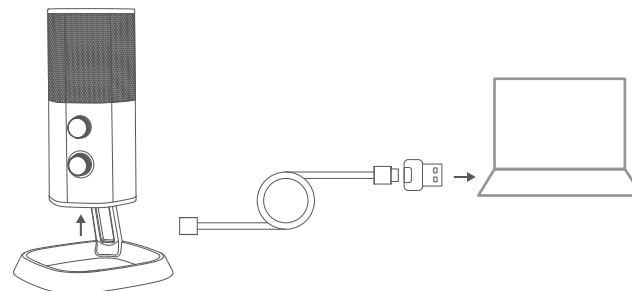

Frequency Response

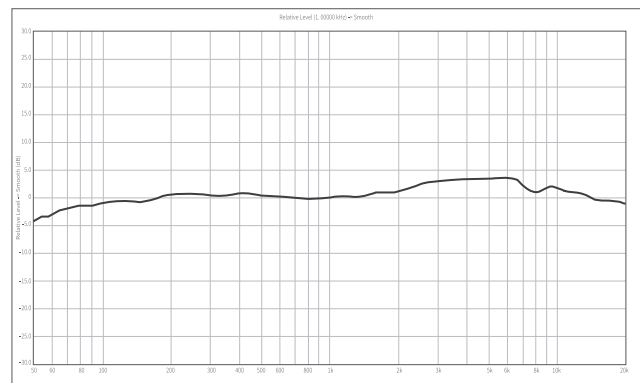

Connecting to Computer

Insert one end of the USB-C cable into the USB-C port of the microphone, connect the other end with USB-C to USB-A adapter then insert into the USB port of the computer. Select Microphone (UMic22) in the input device of system setting.

Note: The microphone will automatically enter charging mode after connecting to power source via USB-C cable. Even if it's powered down, the battery level indicators will still flash blue until fully charged.

Directivity

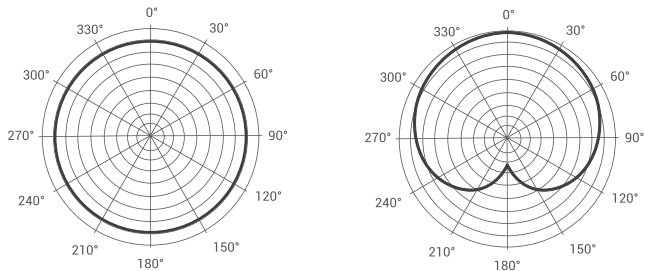

Technical Data

Model	UMic22
Pickup Pattern	Cardioid, Omnidirectional
Sensitivity of Cardioid Pattern	-36dB±3dB
Sensitivity of Omnidirectional Pattern	-36dB±3dB
Input Parameter	5V = 1A
Lithium Battery Parameter	3.8V = 770mAh
Frequency Response	20Hz-20kHz
Max. SPL	120dB
SNR	60-75dB
Sampling Rate	48kHz
Volume Adjustment Range	1-10
Gain Adjustment Range	1-10
Working Time	Approx. 25h
2.4GHz Transmission Range	Max. Wireless Distance 100m (when using with MoveLink II RX)
Working Environment Temperature	-10°C ~ +50°C
Dimension	2.24"*6.73"*4.09"
Net Weight	276g

Specifications and data may subject to changes without notice.

Maintenance

Avoid sudden drops. The device may fail to work after strong shocks, impacts, or excess stress.

Keep dry. The product isn't water-proof. Malfunction, rust, and corrosion may occur and go beyond repair if soaked in water or exposed to high humidity.

Avoid sudden temperature changes. Condensation happens if sudden temperature changes such as the circumstance when taking the transmitter and receiver out of a building with higher temperature to outside in winter. Please put the transmitter and receiver in a handbag or plastic bag beforehand.

Keep away from strong magnetic field. The strong static or magnetic field produced by devices such as radio transmitters leads to malfunction.

This product, except consumables e.g. lapel microphone, is supported with a one-year warranty.

Unauthorized service will void the warranty.

If the product had failures or was wetted, do not use it until it is repaired by professionals.

Changes made to the specifications or designs may not be reflected in this manual.

FCC Statement

This device complies with part 15 of the FCC Rules. Operation is subject to the following two conditions:

- (1) This device may not cause harmful interference, and
- (2) this device must accept any interference received, including interference that may cause undesired operation.

Any Changes or modifications not expressly approved by the party responsible for compliance could void the user's authority to operate the equipment.

Note: This equipment has been tested and found to comply with the limits for a Class B digital device, pursuant to part 15 of the FCC Rules. These limits are designed to provide reasonable protection against harmful interference in a residential installation. This equipment generates uses and can radiate radio frequency energy and, if not installed and used in accordance with the instructions, may cause harmful interference to radio communications. However, there is no guarantee that interference will not occur in a particular installation. If this equipment does cause harmful interference to radio or television reception, which can be determined by turning the equipment off and on, the user is encouraged to try to correct the interference by one or more of the following measures:

- Reorient or relocate the receiving antenna.
- Increase the separation between the equipment and receiver.
- Connect the equipment into an outlet on a circuit different from that to which the receiver is connected.
- Consult the dealer or an experienced radio/TV technician for help.

The device has been evaluated to meet general RF exposure requirement. The device can be used in portable exposure condition without restriction.

Warning

Operating frequency: 2402MHz ~ 2480MHz
Maximum EIRP Power: 5dBm

Declaration of Conformity:

GODOX Photo Equipment Co.,Ltd. hereby declares that this equipment are in compliance with the essential requirements and other relevant provisions of Directive 2014/53/EU. In accordance with Article 10(2) and Article 10(10), this product is allowed to be used in all EU member states. For more information of DoC, Please click this web link:

<https://www.godox.com/eu-declaration-of-conformity/>

The device complies with RF specifications when the device used at 0mm from your body.

产品保修

尊敬的用户,本保修卡是申请保修服务的重要凭证,请您配合销售商填写并妥善保管,谢谢!

产品信息	型号	产品条码
	姓名	联系电话
用户信息	通信地址	
	名称	
销售商信息	联系电话	
	通信地址	
	销售日期	
备注		

注: 此表应由销售商盖章确认。

产品信息

本文件适用于相关《产品保修信息》(见后面说明)所列产品,其他非属此范围的产品或部件(如促销品、赠品及其他出厂后附加的部件等)不在此保修承诺内。

保修期

产品及部件的相应保修期按相关的《产品保修信息》执行,保修期自产品首次购买日起算,购买日以购买产品时保修卡登记日期为准。

如何获得保修服务

要保修服务,您可直接与产品销售商或授权服务机构联系,也可拨打神牛产品服务电话,与我们联系,由我们的服务人员为您安排服务,申请保修时,您应提供有效的保修卡作为保修凭证,方可获得保修,如您不能提供有效的保修卡,则在我们可确认产品或部件属于保修范围的情况下,也可以为您提供保修,但这不作为我们的义务。

不适用保修的情况

如产品存在下列情况,本文件项下的保证和服务将不适用 ① 产品或部件超过相应保修期; ② 错误或不适当使用、维护或保管导致的故障或损坏,如: 不当搬运,非按产品合理预期用途使用,不当插拔外接设备,跌落或外力挤压; 接触或暴露于不当温度、溶剂、酸碱、水浸或潮湿环境; ③ 由非神牛授权机构或人员安装、修理、更改、添加或拆卸造成的故障或损坏; ④ 产品或部件原有识别信息被修改变更或删除; ⑤ 无有效保修卡; ⑥ 使用非合法授权、非标准或非公开发行的软件造成的故障或损坏; ⑦ 因不可抗力或意外事件造成的故障或损坏; ⑧ 其他非因产品本身质量问题导致的故障或损坏,遇上述情况,您应向相关责任方寻求解决,神牛对此不承担任何责任,因非在保修期或保修范围内的部件、附件或软件导致产品不能正常使用的,不是保修范围内的故障,产品使用过程中正常的脱色,磨损和消耗,不是保修范围内的故障。

产品保修和服务支持信息

产品的保修期和服务类型按以下《产品保修信息》执行:

产品类别	选件名称	保修期(月)	保修服务类型
部件	电路板	12	客户送修
	电池	3	客户送修
	充电器等带电性能的部件	12	客户送修
其他	如电池盒、防风棉、防风罩、锁紧装置、手提绳、扎带、魔术贴、领夹、便携袋、包装等	无	无保修

神牛产品售后服务电话 0755-29609320-8062

Warranty

Dear customers, as this warranty card is an important certificate to apply for our maintenance service, please fill in the following form in coordination with the seller and safe-keep it. Thank you!

Product Information	Model	Product Code Number
Customer Information	Name	Contact Number
	Address	
Seller Information	Name	
	Contact Number	
	Address	
	Date of Sale	
Note		

Note: This form shall be sealed by the seller.

How to Get the Maintenance Service

If maintenance service is needed, you can directly contact the product distributor or authorized service institutions. You can also contact the Godox after-sale service call and we will offer you service. When applying for maintenance service, you should provide valid warranty card. If you cannot provide valid warranty card, we may offer you maintenance service once confirmed that the product or accessory is involved in the maintenance scope, but that shall not be considered as our obligation.

Inapplicable Cases

The guarantee and service offered by this document are not applicable in the following cases: ①. The product or accessory has expired its warranty period; ②. Breakage or damage caused by inappropriate usage, maintenance or preservation, such as improper packing, improper usage, improper plugging in/out external equipment, falling off or squeezing by external force, contacting or exposing to the improper temperature, solvent, acid, base, flooding and damp environments, etc; ③. Breakage or damage caused by non-authorized institution or staff in the process of installation, maintenance, alternation, addition and detachment; ④. The original identifying information of product or accessory is modified, alternated, or removed; ⑤. No valid warranty card; ⑥. Breakage or damage caused by illegally authorized, nonstandard or non-public released software; ⑦. Breakage or damage caused by force majeure or accident; ⑧. Breakage or damage that could not be attributed to the product itself. Once met these situations above, you should seek solutions from the related responsible parties and Godox assumes no responsibility. The damage caused by parts, accessories and software that beyond the warranty period or scope is not included in our maintenance scope. The normal discoloration, abrasion and consumption are not the breakage within the maintenance scope.

Maintenance and Service Support Information

The warranty period and service types of products are implemented according to the following Product Maintenance Information:

Product Type	Name	Maintenance Period(month)	Warranty Service Type
Parts	Product Main Body	12	Customer sends the product to designated site
	Battery	3	Customer sends the product to designated site
	Charger, Electrical Parts etc.	12	Customer sends the product to designated site
Other Items	Battery Case, Windscreen Foam, Wind Cap, Locking Device, Lanyard, Tie, Velcro Tape, Clip, Bag, Package etc.	No	Without warranty

Godox After-sale Service Call 0755-29609320-8062

Applicable Products

The document applies to the products listed on the Product Maintenance Information (see below for further information). Other products or accessories (e.g. promotional items, giveaways and additional accessories attached, etc.) are not included in this warranty scope.

Warranty Period

The warranty period of products and accessories is implemented according to the relevant Product Maintenance Information. The warranty period is calculated from the day (purchase date) when the product is bought for the first time, and the purchase date is considered as the date registered on the warranty card when buying the product.