

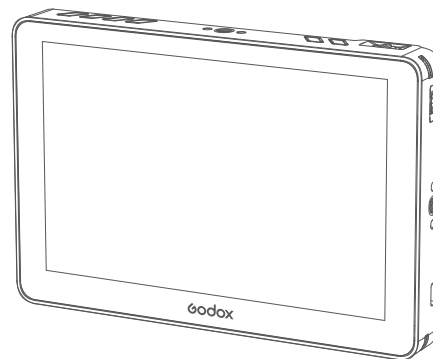

# Godox



Wechat  
Official Account  
神牛微信公众号

深圳市神牛摄影器材有限公司

地址: 深圳市宝安区福海街道塘尾社区耀川工业区厂房2栋 电话: 0755-29609320(8062)

传真: 0755-25723423 邮箱: godox@godox.com

**GODOX Photo Equipment Co., Ltd.**

Add.: Building 2, Yaochuan Industrial Zone, Tangwei Community, Fuhai Street, Bao' an District, Shenzhen

518103, China Tel: +86-755-29609320(8062) Fax: +86-755-25723423 E-mail: godox@godox.com

[www.godox.com](http://www.godox.com)

Made in China | 705-GM7S00-01



# GM7S

7寸 4K HDMI 高亮监视器  
4K HDMI 7" Ultra Bright Camera Monitor

使用手册  
Instruction Manual

## 前言

感谢购买神牛产品!

欢迎使用神牛 7 寸 4K HDMI 高亮监视器 GM7S, 本产品配合单反相机、摄像机使用, 内置多种摄影专用辅助与监看功能, 适用于摄影及摄像现场监视监听, 是移动及外景拍摄的最佳搭档。

请仔细阅读本说明书, 以便能正确的操作, 发挥本产品的优越性能。

## 主要特点:

- 7 寸 IPS 高亮触摸屏
- HDMI@1.4 输入输出, 可同步监视画面
- 3.5mm 耳机孔, 能实时监听相机音源
- 支持相机控制, 触摸调节, 具备拍照、录制、对焦、调焦、感光度、光圈、快门控制功能
- 支持 SD 卡导入 LUT 和固件升级文件, 支持 17/32/33/64/65 立方体
- 多种供电方式: DC 电源供电、Type-C 接口供电和双锂电供电

## 警告

- ⚠ 请勿私自拆卸产品, 如产品出现故障须由本公司或授权的维修人员进行检查维修。
- ⚠ 请保持干燥! 请勿用湿手接触产品, 亦不可将产品浸入水中或暴露于雨中。
- ⚠ 请勿在易燃易爆环境中使用! 在这些场合下, 请注意相关警告标识。
- ⚠ 请勿放置在超过 50 度的高温环境中。
- ⚠ 请勿让儿童接触本产品。
- ⚠ 若发生任何故障, 请立即关闭电源。
- ⚠ 使用电池的注意事项:  
只能使用本手册中列出的电池。  
请仔细阅读并遵守由厂商提供的警告或指示。  
切勿使电池短路或拆卸电池。

## 产品结构

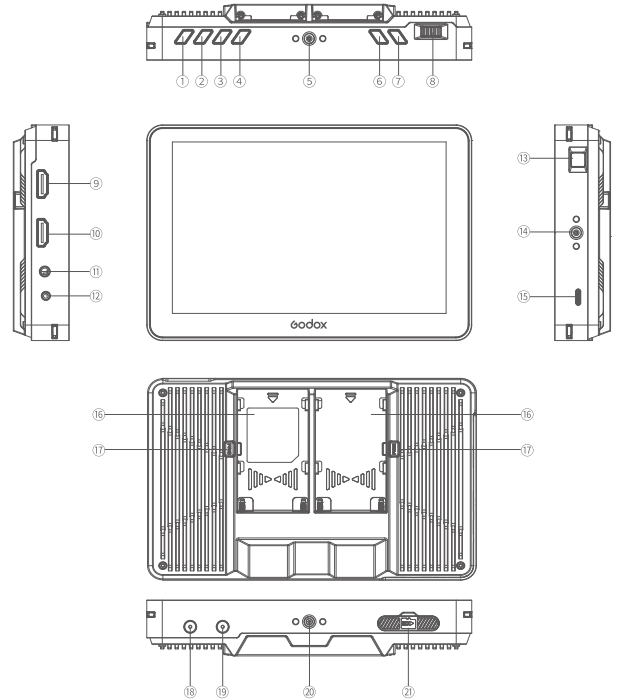

- |           |             |               |              |              |
|-----------|-------------|---------------|--------------|--------------|
| 1. 快捷键 F1 | 5. 1/4 扩展接口 | 9. HDMI 输出接口  | 13. 电源键      | 17. 自锁式电池开关  |
| 2. 快捷键 F2 | 6. 快捷键 F5   | 10. HDMI 输入接口 | 14. 1/4 扩展接口 | 18. DC 输出接口  |
| 3. 快捷键 F3 | 7. 返回键      | 11. 音频接口      | 15. USB-C 接口 | 19. DC 输入接口  |
| 4. 快捷键 F4 | 8. 菜单拨轮     | 12. 相机控制接口    | 16. 电池仓      | 20. 1/4 扩展接口 |
|           |             |               |              | 21. SD 卡槽    |

## 标配物品



监视器x1



冷靴云台x1



遮光罩x1



标准HDMI转Mini线x1



标准HDMI转Micro线x1



标准HDMI转标准HDMI线x1



无尘布x1



产品说明书x1

## 可选购物品

相机控制线、L型支架、防爆箱

请根据不同相机选购相应的相机控制线。

型号	GMC-S2	GMC-U4	GMC-U5	GMC-U6
相机端接口	Multi	Micro USB	Mini USB	USB Type-C



更多相机控制线类型,请登录 Godox 网站查看适用相机型号的最新信息。

## 使用说明

### I. 按键功能

#### 1. 电源键 < >

短按开机,长按关机。

开机状态下,短按锁定屏幕或解锁屏幕:屏幕显示锁定 <  >,表示触摸功能不可用,可防止误操作;屏幕显示解锁 <  >,表示触摸功能可用,可进行触摸功能设置选择。

#### 2. 菜单拨轮 < >

按压菜单拨轮显示主菜单,左右拨动切换选项,按压确认。

#### 3. 返回键 < >

按压返回键可逐级返回菜单直至退出菜单,此按键可配合滚轮按键进行菜单选择及设置。

#### 4. 快捷键 < >

F1-F5 快捷键,根据客户使用习惯自定义设置下列功能:

相机控制、LUT 开关、辅助调焦、伪影、中心标记、安全标记、网格线、遮幅区域等。

## II. 触摸功能

### 1. 呼出 / 退出菜单

连续双击屏幕即可呼出菜单,点击菜单区域进行相应设置或选择,单击视频区域退出菜单显示。

### 2. 显示 / 隐藏相机控制

当相机控制开时,从屏幕右侧向左滑动后调出菜单,单击以外区域隐藏菜单。

### 3. 显示 / 隐藏示波器

当示波器功能开时,在屏幕右下角区域显示图形。在图形区域从上向下滑动隐藏显示,从下向上滑动调出图形显示。

## III. 产品功能介绍

### 1. 辅助调焦

帮助快速完成图像对焦,将画面对比度最高的区域用高亮的方式显示出来,提供红、绿、蓝、黄4种颜色选择。

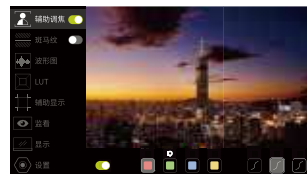

### 2. 斑马纹

调节安全电平参数,可将视频中超过所设斑马纹曝光度的部分以对角线标出,适用于检测和辅助设置画面曝光水平。

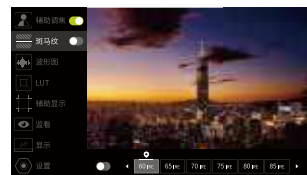

### 3. 波形图

功能	描述
波形图	提供 Y、YUV、RGB、亮度直方图、矢量图的选择
全波形	此功能状态下亮度直方图、矢量图和波形图同时打开, 有助于更直观的分析图像



### 4. LUT

功能	描述
LUT 管理	支持 SD 卡为 NTFS 或 FAT32 文件系统, 本地存储约 25 个自定义 LUT 文件 (1)LUT 导入 触摸操作或按键操作到“LUT 管理”界面, 监视器自动读取并显示 SD 卡内文件夹和 .cube 文件, 选择标注需要导入的 .cube 文件后, 再选择“导入”, 即可开始导入标记的文件。 (2)LUT 删除 触摸操作或按键操作到“LUT 管理”界面, 监视器显示本地已存储的 LUT 文件, 标记需要删除的 LUT 文件后, 再选择“删除”, 即可删除标记的文件。
LUT 加载	选择相应的 LUT 文件可对画面进行色域转换、色彩还原和颜色风格化等操作
对比模式	开启后显示套用 LUT 画面和原始视频画面的对比

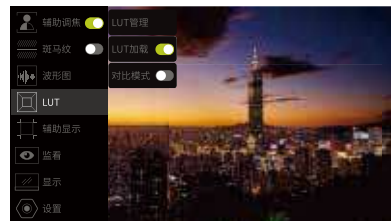

### 5. 辅助显示

功能	描述
显示比例	调整监视器画面显示比例
中心标记	开启该功能时, 十字中心标记显示在监视器屏幕中
安全标记	提供多种标记比例选择, 适用于多比例的安全拍摄需求
遮幅区域	提供多种遮幅比例和透明度调节(默认值为 50)选择, 适用于多比例的后期裁切需求
网格线	提供多种网格类型选择, 适用于辅助画面拍摄构图
线条颜色	选择中心标记、安全标记、遮幅区域和网格线条的颜色, 共 6 种颜色可选, 用户可以针对不同画面选择对比度高的颜色



## 6. 监看

功能	描述
音频柱	开启该功能时,显示峰峰值并缓慢回落,可以监看声音安全
伪彩	提供两种伪彩模式选择,帮助用户观察画面各区域曝光情况
单色显示	可以切换用红色、绿色、蓝色或者灰色来驱动像素点,适用于辅助用户更快的调整画面色调饱和度
像素对应	可以实现视频画面与屏幕的逐像素对应显示
放大	提供 2 倍、4 倍和自定义三种放大选择



## 7. 显示

功能	描述
色彩空间	提供标准 REC.709 色彩空间和原始色彩空间选择
亮度	显示影像亮度调节, 默认值为 50
对比度	显示图像对比度调节, 默认值为 50
饱和度	显示图像饱和度调节, 默认值为 50
锐利度	显示图像锐利度调节, 默认值为 0。通过调低锐利度, 图像看上去更柔和; 而调高锐利度, 图像看上去更清晰
RGB	手动微调监视器的白平衡, 可以通过监视器红、绿、蓝颜色偏移进行微调, 三种颜色默认值均为 128
复位	复位当前用户设置, 初始化颜色设置到默认状态



## 8. 设置

功能	描述
用户模式	提供三种用户自定义模式, 适用于保存不同用户的操作习惯设置
语言	设置界面显示语言, 目前支持英语、中文、德语、日语、法语、意大利语、西班牙语、韩语
电池	电池电量显示功能的打开或关闭
音量	调节监听音量大小, 默认值为 50
背光亮度	调整监视器背光亮度, 默认值为 80
快捷设置	选择 F1-F5 进行相应设置, 18 个选项可选
相机控制	打开相机控制功能, 连接相机控制线(另购)之后, 可通过操作监视器控制相机, 详细说明请参考下文“配件使用说明——相机控制线”
图像翻转	提供左右镜像、上下镜像、自动(传感器)、上下翻转四种翻转模式可选, 适用于用各种观看角度监看画面
恢复出厂	清除当前用户所有个人设置并恢复出厂设置
系统升级	<ol style="list-style-type: none"> <li>(1) 准备一张文件系统是 FAT32 或 NTFS 的 SD 卡和一个 SD 读卡器, PC 端有 SD 卡插槽的则不需要读卡器。</li> <li>(2) 在 PC 端把拷贝的升级文件解压到 SD 卡的根目录, 此时会有一个 xxxx.bin 文件(禁止更改文件名称, 否则会导致升级失败)。</li> <li>(3) 把 SD 卡金手指接触面朝屏幕插入监视器卡槽, 接通电源并开机。</li> <li>(4) 进行系统升级时注意监视器警告提示, 升级过程中请保持电量充足禁止拔卡!</li> <li>(5) 升级完成后系统会自动重启。</li> </ol>
关机	点击关闭监视器



**温馨提示：**相机的 HDMI 输出应设置为**固定分辨率**，如果用户设置为自动或 1080/2160，回放时等待时间可能会偏长。

## 配件使用说明

### 遮光罩

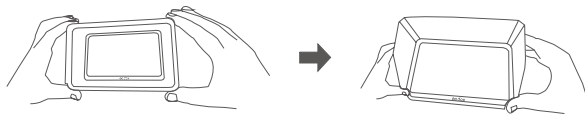

1. 将遮光罩框对准监视器，向下轻压装入，直至四个定位卡扣扣住监视器卡口。
2. 遮光罩对准遮光罩框，将魔术贴贴紧，遮光罩即安装完成。
3. 拆卸遮光罩时，请先拆下遮光罩再抠出遮光罩框。

### 冷靴云台

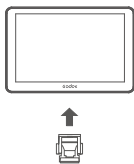

将冷靴云台的 1/4 螺丝对准监视器顶部 / 底部 / 右侧的 1/4 扩展接口，顺时针旋转即可完成安装，逆时针旋转即可拆下冷靴云台（倘无法手动拧紧，可使用附带的小扳手插入转盘卡口拧紧）。冷靴座则通过方形底座或 1/4 螺母连接适配相机或免笼。

### 相机控制线 (另购)

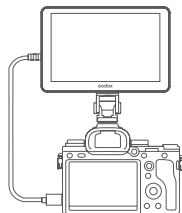

将相机控制线一端连接监视器左下角的相机控制线接口，另一端连接相机，可实现控制相机操作。相机控制功能包括：拍照、录制、对焦、调焦、感光度、光圈、快门。

**注意：**相机控制需要购买相应的相机控制线并需要相机的支持，不是所有相机都支持所有的控制指令，详细支持功能及相机型号请查看相应相机控制线说明书。

### 相机控制功能介绍

在屏幕右侧从屏幕边缘向左侧滑动调出相机控制菜单，也可单击视频区域隐藏菜单，根据需要实时调出与隐藏。



### 图标 功能

图标	功能
	拍照：点击控制相机拍照
	录制：点击控制相机开始录像或结束录像
	对焦：点击触发相机自动调焦
	调焦：点击进入手动调焦二级菜单，增加或减小焦距
ISO	感光度：显示相机当前感光度，点击进入感光度二级菜单，增加或减小感光度



光圈：显示相机当前光圈值，点击进入光圈调节二级菜单，增加或减小光圈



快门：显示相机当前快门值，点击进入快门调节二级菜单，增加或减小快门时间

## 电池安装与拆卸

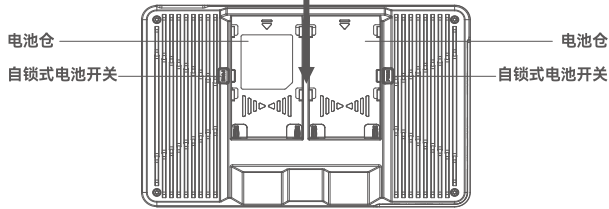

按上图箭头所示方向将锂电池滑入安装到电池仓。取出电池时，先按压自锁式电池开关 PUSH 键，再滑出锂电池。

本监视器可使用市面上通用 F550/F750/F970 锂电池，标配不含电池，请自备锂电池。

## 规格参数

型号	GM7S
显示屏	7 寸 IPS 高亮触摸屏
屏幕比例	16: 10
分辨率	1920x1200
对比度	1000:1
色深	8bit
视角	160°H/160°V
亮度	1200nit±10%
整机功率	约13W
电源	DC 输入：电压范围 7-24V，适配φ5.5mm*2.1 插头 DC 输出：电压范围 7.8±0.3V/1.5A，适配φ5.5mm*2.1 插头 Type-C：18W 以上供电 电池：兼容 NP-F550/NP-F750/NP-F950 锂电池 7.2V
材质	塑胶外框 + 金属后盖

视频格式	480I&576I@50/60Hz 480p&576p@50/60Hz 1280x 720p@50/60Hz 1920x1080I@50/60Hz 1920x1080p@23.98/24/25/29.97/30/50/59/59.94/60Hz 3840x2160p@23.98/24/25/29.97/30Hz 4096x2160p@23.98/24Hz
音频输出	3.5mm 耳机双声道输出
SD 卡槽	支持通过 SD 卡导入 lut 和固件升级，cube 文件支持 17/32/33/64/65 立方体
工作温度	-10~50°C
机身尺寸	18x12x3.1cm
机身重量	507g

## 维护保养

**避免跌落：**如果受到强烈碰撞或振动，此设备可能会发生故障。

**保持干燥：**本产品是非防水产品，如果将其浸入水中或放置于高湿度的环境中将可能发生故障。内部构造生锈可能会导致无法修理的损害。

**避免温度骤变：**温度的突变，可能会造成产品内部结露。

**远离强磁场：**部分设备产生的强静电或强磁场可能会干扰本产品正常工作。经发现擅自维修或人为损坏此设备，将取消一年保修期，维修需要收取相关费用。

如果本品出现故障或者被水淋湿，在专业人员维修后方可继续使用。

如有技术更改，恕不另行通知。

## Forward

Thank you for purchasing !

With multiple professional auxiliary functions, this monitor GM7S can be used with DSLR cameras and camcorders, which is suitable for onsite monitoring and recording of photography.

Please read this manual carefully before using to make sure the correct operation and exert the optimum function.

## Main Features

- 7 inches wide view angle IPS HD ultra-bright touch screen
- HDMI@1.4 Output or Input
- 3.5mm audio jack port to achieve real-time audio monitoring
- Support camera control with touch operation, shooting, recording, auto focus, focusing, ISO, aperture and shutter control functions provided
- Support LUT lead-in with SD card & compatible with 17/32/33/64/65 cubic files
- Various power supplies: DC power supply, Type-C power supply and lithium battery power supply

## Warning

- ⚠ Do not disassemble. Should repairs become necessary, this product must be sent to an authorized maintenance center.
- ⚠ Always keep this product dry. Do not use in rain or in damp conditions.
- ⚠ Do not use the product in the presence of flammable gas. In certain circumstance, please pay attention to the relevant warnings.
- ⚠ Do not leave or store the product if the ambient temperature reads over 50°C.
- ⚠ Keep out of reach of children.
- ⚠ Turn off the device immediately in the event of malfunction.
- ⚠ Observe precautions when handling batteries:

Use only batteries listed in this manual.

Read and follow all warnings and instructions provided by the manufacturer.

Batteries cannot be short-circuited or disassembled.

## Structure of the Product

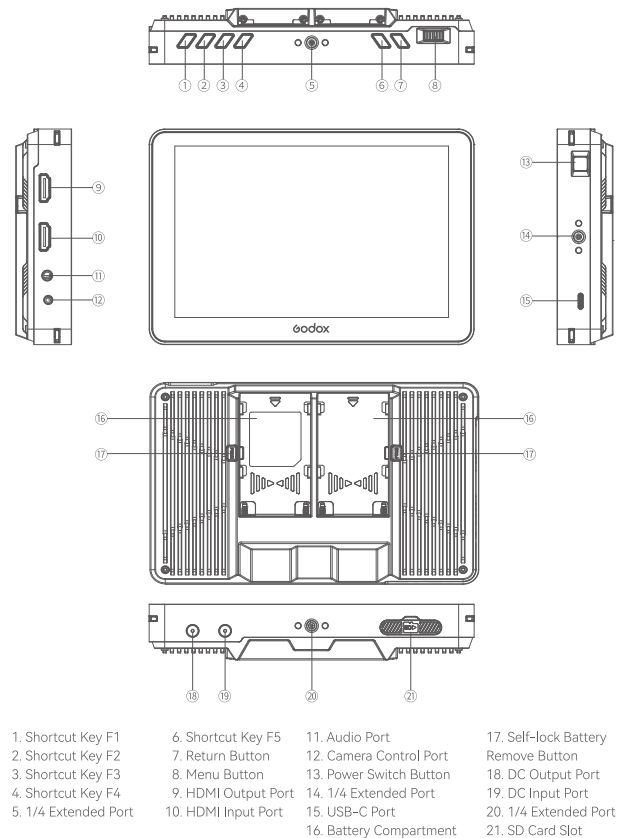



## Included Items



Monitor x1



Hood x1



Cold Shoe Mount x1



Standard HDMI to Mini Cable x1



Standard HDMI to Micro Cable x1



Standard HDMI to Standard HDMI Cable x1



Dustless Cloth x1



Instruction Manual x1

## Optional Accessories

Camera Control Cable, L-Mount, Hard Carry Case

Please purchase different camera control cables(optional) according to different camera models.

Model	GMC-S2	GMC-U4	GMC-U5	GMC-U6
Camera Port	Multi	Micro USB	Mini USB	USB Type-C



More camera control cable, please visit the Godox website to gain the updated information of support camera models.

## Operating Instruction

### I. Button Operation

#### 1. Power Switch Button< >

Short press this button to power on, long press to power off.

Power on and short press this button to switch on or off the touch function: the touch function is off when the panel is locked and <  > icon is displayed; the touch function is on when the panel is unlocked and <  > icon is displayed.

#### 2. Menu Button< >

Press down this button to enter the main menu, turn it leftwards or rightwards to choose the needed options and press down to confirm and set.

#### 3. Return Button< >

Press this button to return to the previous menu until exiting. It can also be collocated with the menu button to change and set parameters.

#### 4. Shortcut Key< >

Shortcut Key F1 to F5 can be set as the following functions according to the user's custom: Camera Control, LUT Switch, Focus Assist, False Color, Center Marker, Safety Marker, Grid Line, Marker Mat, etc.

## II. Touch Operation

### 1. Bring Out/Hide the Menu

Double-click the screen to bring out main menu. Click the menu area to choose and set, single-click the video area to exit the menu.

### 2. Bring Out/Hide the Camera Control Menu

When the camera control function is on, slide leftwards from the screen edge on the right to bring out the camera control menu, single-click the other area to exit the camera control menu.

### 3. Bring out/Hide the Waveform

When the waveform function is on, waveform will be displayed on the bottom right of the panel. Slide the displayed area downwards to hide the waveform while upwards to display it.

## III. Menu Function Description

### 1. Focus Assist

Focus assist function helps focus your images fast, displays edge lines on the sharpest areas of the image with four colors for choice (Red, Green, Blue, Yellow).

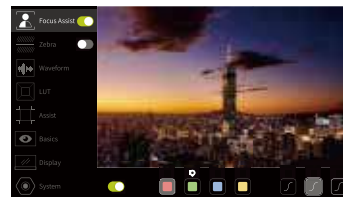

## 2. Zebra

The zebra feature is designed to check exposure and set exposure levels, which helps you achieve optimum exposure by displaying diagonal lines over areas of the video that exceed your set zebra level.

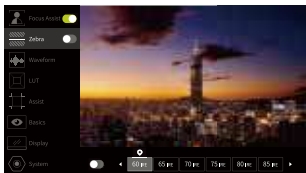

## 3. Waveform

Function	Description
Waveform	There are four waveforms for your choice: Y, YUV, RGB, Y Histogram and Vector.
All Waveform	Switch this function on, all the waveforms will display. It helps analyze images more intuitively.

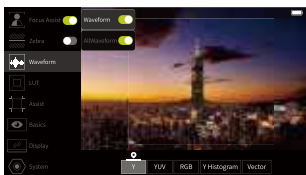

## 4. LUT

Function	Description
LUT Manage	This monitor, with 25 LUT files stored at most, supports SD card which belongs to NTFS or FAT32 file system. (1)LUT Import Enter the "LUT Manage" interface, the monitor will automatically read and display folders in SD card and .cube files. Choose the .cube files to be imported and click the "Import" icon, the monitor will start importing.

	(2)LUT Delete Enter the "LUT Manage" interface, the monitor will automatically read and display the LUT files stored. Choose the LUT files to be deleted and click the "Delete" icon, the monitor will start deleting.
LUT Load	"Select" the needed LUT files to transform the color gamut, restore and stylize the color.
LUT Compare	Turn on the "LUT Compare" to display the differences between the applied LUT interface and original video interface.

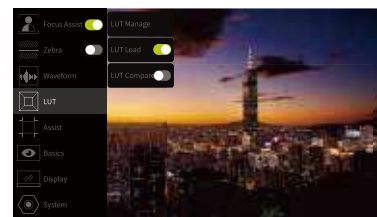

## 5. Assist

Function	Description
Video Aspect	Adjust the display scale of the monitor.
Center Marker	Turn on this function, a cross marker will display on the panel.
Safety Marker	Provide several safety markers to meet the different shooting safety requirements.
Marker Mat	Provide various marker ratios and transparency adjustments (50 by default), designed to meet different post-production cutting needs.
Grid Line	Different grid line options are suitable to help shooting composition.
Marker Color	6 color choice for the users to set the colors of Center Marker, Safety Marker, Marker Mat and Grid Line, in order to achieve high contrast for every image.

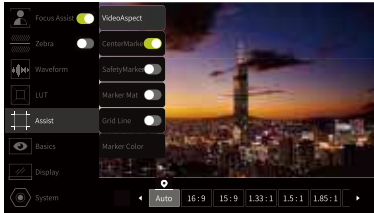

## 6. Basics

Function	Description
Audio Meter	This function is designed to monitor the audio safety by displaying the peak and then slowly falling down.
False Color	Two false color choices for the users to observe the exposure of each area.
Monochrome	Users can switch to drive pixels with red, green, blue or gray, which is suitable for adjusting the hue saturation of the image quickly.
Pixel to Pixel	Realize the pixel to pixel corresponding display of the video and the screen.
Zoom	Zoomable in double, quadruple and customized times.

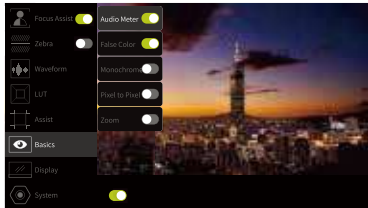

## 7. Display

Function	Description
Color Space	Provide standard REC.709 color space and origin color space.

Brightness	Adjust the brightness of the video and image, 50 by default.
Contrast	Adjust the contrast of the video and image, 50 by default.
Saturation	Adjust the saturation of the video and image, 50 by default.
Sharpness	Adjust the sharpness of the video and image, 0 by default. The image will be softer by decreasing the sharpness while clearer by increasing the sharpness.
RGB	Manually adjust the white balance of the monitor by color offsetting of Red, Green and Blue, which are all 128 by default.
Reset	Reset the current user's color settings and initialize to the default state.

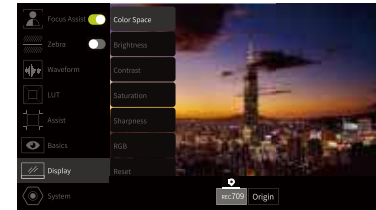

## 8. System

Function	Description
User Setting	Three customized user modes for choice.
Language	English, Chinese, German, Japanese, French, Italian, Spanish and Korean for the users to set system language.
Battery Tip	Turn on to display the current battery level.
Volume	Adjust the monitoring volume, 50 by default.
Backlight	Adjust the backlight of the monitor, 80 by default.
Shortcut	There are 5 shortcut keys with 18 options for the users to set according to their preferential customs.

Camera Control	Turn on the Camera Control function and connect to a camera through Monitor Camera Control Cable (sold separately), then you can control the camera with the monitor. Please refer to the section "Accessories Instruction—Monitor Camera Control Cable".
Image Flip	Provide left-right mirror flip, up-down mirror flip, auto (sensor) and up-down flip modes to choose the suitable monitoring angel.
Restore Factory	Clear all the current user settings and restore to factory settings.
Upgrade	(1) Prepare a SD card whose file system is FAT32 or NTFS and an SD card reader. If the PC has a SD card slot, the reader is not needed. (2) Extract the upgrade files copied to the root directory of SD card on the PC side. There will be a xxxx.bin file (Do not change file name, otherwise, the upgrade will fail.) (3) Insert the SD card into the slot of monitor with the face of connecting finger towards the screen. Turn on the power. (4) Click "upgrade" to start upgrading. Pay attention to the warnings on the screen and keep the power being supplied and do not pull out the card during the upgradation! (5) The monitor will automatically boot up after upgradation finished.
Power down	Click to shut down the device.

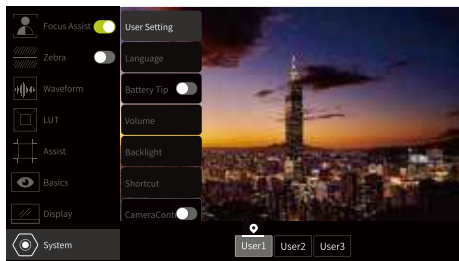

**Tips:** The HDMI output of the camera should be set to a **fixed resolution**. If the user changes to auto or 1080/2160, the latency time may be longer when switching to the playback state.

## Accessories Instruction

### Hood

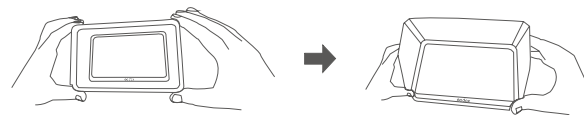

1. Align the hood frame with the monitor and press it down until the four positioning buckles are firmly mounted on the monitor corners.
2. Align the hood with the hood frame and stick the velcro properly to finish the installation.
3. Please take off the hood first and then the hood frame when detaching from the monitor.

### Cold Shoe Mount

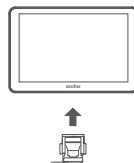

Align the 1/4 screw of the cold shoe mount with the 1/4 extended ports on the top/bottom/right side of the monitor, turn it clockwise to install while counterclockwise to remove (if you can't tighten it manually, use the attached mini wrench to help). The cold shoe base can be mounted to the camera or rig.

### Monitor Camera Control Cable (Sold Separately)

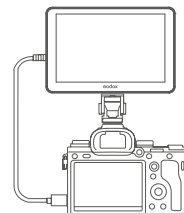

Connect the monitor and compatible camera with the camera control cable to achieve camera control through the monitor. The following functions are available: shooting, recording, auto focus, focusing, ISO, aperture and shutter.

Note: To achieve camera control, it is recommended to purchase corresponding camera control cable and gain support of camera. As the control functions are not supported by all cameras, please refer to the relevant instruction manual of the camera control cable to check its support functions and camera models.

## Camera Control Function Introduction

When the camera control is on, slide leftwards from the screen edge on the right to bring out the camera control menu, single-click the video area to hide the camera control menu.



### Icon Function

-  Shooting: Click to control the camera to shoot.

---

-  Recording: Click to control the camera to record.

---

-  Auto focus: Click to control the camera to automatically focus.

---

-  Focusing: Click to enter the focal length adjustment secondary menu to increase or decrease the focal length manually.

---

-  ISO: Display the current photosensitivity, click to enter the photosensitivity adjustment secondary menu to increase or decrease the photosensitivity manually.

---

-  Aperture: Display the current aperture, click to enter the aperture adjustment secondary menu to increase or decrease the aperture manually.

---

-  Shutter: Display the current shutter speed, click to enter the shutter speed adjustment secondary menu to increase or decrease the shutter speed manually.

## Installing and Detaching the Battery

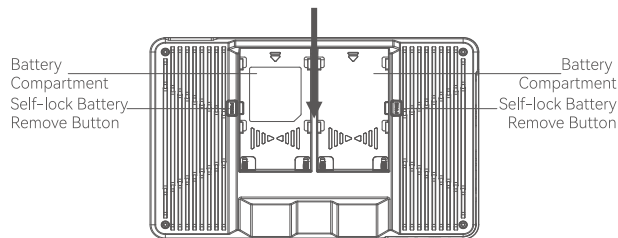

Installation: slide the lithium battery into the battery compartment in the direction of the arrow above. Disassembly: Push down the self-lock battery remove button then slide out the lithium battery.

This monitor is compatible with F550/F750/F970 lithium battery (sold separately).

### Technical Data

Model	GM7S
Screen	7" IPS HD ultra-bright touch screen
Screen Ratio	16: 10
Resolution	1920x1200
Contrast Ratio	1000:1
Color Depth	8bit
Visual Angle	160°H/160°V
Brightness	1200nit±10%
Power	Approx.13W
Power Supply	DC Input: 7-24V, $\phi$ 5.5mm*2.1 plug DC Output: 7.8±0.3V/1.5A, $\phi$ 5.5mm*2.1 plug Type-C: power supply above 18W Lithium Battery: NP-F550/NP-F750/NP-F970 lithium battery, 7.2V
Material	Plastic frame & metal shell
Video Format	480I&576I@50/60Hz

	480p&576p@50/60Hz 1280x720p@50/60Hz 1920x1080l@50/60Hz 1920x1080p@23.98/24/25/29.97/30/50/59/59.94/60Hz 3840x2160p@23.98/24/25/29.97/30Hz 4096x2160p@23.98/24/25/29.97/30Hz
Audio Output	3.5mm Earphone dual-channel output
SD Card Slot	Support importing .cube files and firmware upgrade by SD card Support 17/32/33/64/65 cube
Working Temperature	-10~50°C
Dimension	18x12x3.1cm
Net Weight	507g

## Maintenance

Avoid sudden drops. The device may fail to work after strong shocks, impacts, or excess stress.

Keep dry. The product isn't water-proof. Malfunction, rust, and corrosion may occur and go beyond repair if soaked in water or exposed to high humidity.

The sudden temperature changes may cause product condensation.

Keep away from strong magnetic field. The strong static or magnetic field produced by devices leads to malfunction.

Unauthorized service or artificial damage will void the warranty. In those situations, maintenance fees will be charged.

If the product had failures or was wetted, do not use it until it is repaired by professionals.

Changes made to the specifications or designs may not be reflected in this manual.

## FCC Statement

This device complies with part 15 of the FCC Rules. Operation is subject to the following two conditions:

- (1) This device may not cause harmful interference, and
- (2) this device must accept any interference received, including interference that may

cause undesired operation.

Any Changes or modifications not expressly approved by the party responsible for compliance could void the user's authority to operate the equipment.

Note: This equipment has been tested and found to comply with the limits for a Class B digital device, pursuant to part 15 of the FCC Rules. These limits are designed to provide reasonable protection against harmful interference in a residential installation. This equipment generates uses and can radiate radio frequency energy and, if not installed and used in accordance with the instructions, may cause harmful interference to radio communications. However, there is no guarantee that interference will not occur in a particular installation. If this equipment does cause harmful interference to radio or television reception, which can be determined by turning the equipment off and on, the user is encouraged to try to correct the interference by one or more of the following measures:

-Reorient or relocate the receiving antenna.

-Increase the separation between the equipment and receiver.

-Connect the equipment into an outlet on a circuit different from that to which the receiver is connected.

-Consult the dealer or an experienced radio/TV technician for help.

## Declaration of Conformity:

GODOX Photo Equipment Co.,Ltd. hereby declares that the This equipment are in compliance with the essential requirements and other relevant provisions of EU Directive 2014/30/EU.They are allowed to be used in all EU member states. For more information of DoC, Please click this web link:

[https://www.godox.com/DOC/Godox\\_GM7S\\_DOC.pdf](https://www.godox.com/DOC/Godox_GM7S_DOC.pdf)

## 产品保修

尊敬的用户, 本保修卡是申请保修服务的重要凭证, 请您配合销售商填写并妥善保管, 谢谢!

产品信息	型号	产品条码
用户信息	姓名	联系电话
	通信地址	
销售商信息	名称	
	联系电话	
	通信地址	
	销售日期	
备注		

注: 此表应由销售商盖章确认。

## 产品信息

本文件适用于相关《产品保修信息》(见后面说明)所列产品, 其他非属此范围的产品或部件(如促销品、赠品及其他出厂后附加的部件等)不在此保修承诺内。

## 如何获得保修服务

要保修服务, 您可直接与产品销售商或授权服务机构联系, 也可拨打神牛产品售后服务电话, 与我们联系, 由我们的服务人员为您安排服务。申请保修时, 您应提供有效的保修卡作为保修凭证, 方可获得保修。如您不能提供有效的保修卡, 则在我们可确认产品或部件属于保修范围的情况下, 也可以为您提供保修, 但这不作为我们的义务。

## 不适用保修的情况

如产品存在下列情况, 本文件项下的保证和服务将不适用 ① 产品或部件超过相应保修期; ② 错误或不当使用、维护或保管导致的故障或损坏, 如:

不当搬运; 非按产品合理预期用途使用; 不当插拔外接设备; 跌落或外力挤压; 接触或暴露于不适当温度、溶剂、酸碱、水浸或潮湿环境; ③ 由非神牛授权机构或人员安装、修理、更改、添加或拆卸造成的故障或损坏; ④ 产品或部件原有识别信息被修改变更或删除; ⑤ 无有效保修卡; ⑥ 使用非合法授权、非标准或非公开发行的软件造成的故障或损坏; ⑦ 因不可抗力或意外事件造成的故障或损坏; ⑧ 其他非因产品本身质量问题导致的故障或损坏。遇上述情况, 您应向相关责任方寻求解决, 神牛对此不承担任何责任。因非在保修期或保修范围内的部件、附件或软件导致产品不能正常使用的, 不是保修范围内的故障。产品使用过程中正常的脱色, 磨损和消耗, 不是保修范围内的故障。

## 产品保修和服务支持信息

产品的保修期和服务类型按以下《产品保修信息》执行:

产品类别	选件名称	保修期 (月)	保修服务类型
部件	主机	12	客户送修
	电池	3	客户送修
	充电器等带电性能的部件	12	客户送修
其他	如电池盒、防风棉、防风毛罩、锁紧装置、手提绳、扎带、魔术贴、领夹、便携袋、包装等	无	无保修

神牛产品售后服务电话: 0755-29609320-8062

## Warranty

Dear customers, as this warranty card is an important certificate to apply for our maintenance service, please fill in the following form in coordination with the seller and safe-keep it. Thank you!

Product Information	Model	Product Code Number
Customer Information	Name	Contact Number
	Address	
Seller Information	Name	
	Contact Number	
	Address	
	Date of Sale	
Note:		

Note: This form shall be sealed by the seller.

## Applicable Products

The document applies to the products listed on the Product Maintenance information (see below for further information). Other products or accessories (e.g. promotional items, giveaways and additional accessories attached, etc.) are not included in this warranty scope.

## Warranty Period

The warranty period of products and accessories is implemented according to the relevant Product Maintenance Information. The warranty period is calculated from the day (purchase date) when the product is bought for the first time, and the purchase date is considered as the date registered on the warranty card when buying the product.

## How to Get the Maintenance Service

If maintenance service is needed, you can directly contact the product distributor or authorized service institutions. You can also contact the Godox after-sale service call and we will offer you service. When applying for maintenance service, you should provide valid warranty card. If you cannot provide valid warranty card, we may offer you maintenance service once confirmed that the product or accessory is involved in the maintenance scope, but that shall not be considered as our obligation.

## Inapplicable Cases

The guarantee and service offered by this document are not applicable in the following cases: ①. The product or accessory has expired its warranty period; ②. Breakage or damage caused by inappropriate usage, maintenance or preservation, such as improper packing, improper usage, improper plugging in/out external equipment, falling off or squeezing by external force, contacting or exposing to the improper temperature, solvent, acid, base, flooding and damp environments, etc; ③. Breakage or damage caused by non-authorized institution or staff in the process of installation, maintenance, alternation, addition and detachment; ④. The original identifying information of product or accessory is modified, alternated, or removed; ⑤. No valid warranty card; ⑥. Breakage or damage caused by using illegally authorized, nonstandard or non-public released software; ⑦. Breakage or damage caused by force majeure or accident; ⑧. Breakage or damage that could not be attributed to the product itself. Once met these situations above, you should seek solutions from the related responsible parties and Godox assumes no responsibility. The damage caused by parts, accessories and software that beyond the warranty period or scope is not included in our maintenance scope. The normal discoloration, abrasion and consumption are not the breakage within the maintenance scope.

## Maintenance and Service Support Information

The warranty period and service types of products are implemented according to the following

Product Type	Name	Maintenance Period(month)	Warranty Service Type
Parts	Product Main Body	12	Customer sends the product to designated site
	Battery	3	Customer sends the product to designated site
	Charger, Electrical Parts etc.	12	Customer sends the product to designated site
Other Items	Battery Case, Windscreen Foam, Wind Cap, Locking Device, Lanyard, Tie, Velcro Tape, Clip, Bag, Package etc.	NO	Without warranty

Godox After-sale Service Call 0755-29609320-8062