

Godox

威客大功率环形闪光灯
Powerful Ring Flash

WITSTRO⁺AR400

合格证
QC PASS

深圳市神牛摄影器材有限公司

地址: 深圳市宝安区福海街道塘尾社区耀川工业区厂房2栋
电话: 0755-29609320(8062) 传真: 0755-25723423 邮箱: godox@godox.com

GODOX Photo Equipment Co., Ltd.

Add.: Building 2, Yaochuan Industrial Zone, Tangwei Community, Fuhai Street, Bao'an District,
Shenzhen 518103, China Tel: +86-755-29609320(8062) Fax: +86-755-25723423
E-mail: godox@godox.com

godox.com

Made in China



使用手册
INSTRUCTION MANUAL

在使用本产品之前，请先仔细阅读本手册，以确保您能安全使用。请保存好本手册以备将来查询参考。

感谢您购买神牛产品。

神牛大功率环形闪光灯AR400功率大、体积小、重量轻、易携带，既可作为环形闪光灯使用，也可作为外拍闪光灯使用，还可充当LED灯提供稳定光源，为人像摄影、婚礼现场、采光布光、静物拍摄等提供专业而有效的布光方案。产品具有以下特点：

- 功率达400Ws，闪光指数36
- 全功率闪光400次以上，0.05-3秒快速回电
- 功率调节范围大(1/1~1/128)，22级精确微调，光效把握更随心
- 色温恒定，全程保持5600±200K
- 支持高速频闪，高速同步等功能
- 使用专配遥控器，可无线遥控闪光灯各种功能和触发闪
- 专业锂电池供电，电量大(10.8V/4000mAh)
- 具备LED常亮灯，分三档控制，可做连续光源使用

 警告

- ▲ 请保持干燥。
- ▲ 请勿私自拆卸产品，如产品出现故障须由本公司或授权的维修人员进行检查维修。
- ▲ 请勿让儿童接触本产品。
- ▲ 禁止拆卸、撞击、挤压或投入火中，若出现严重鼓胀，请勿继续使用。
- ▲ 请勿放置在超过50度的高温环境中。
- ▲ 请勿将闪光灯头正对人眼闪光(特别是婴儿的眼睛)，否则可能会在短时间内造成视力障碍。
- ▲ 请勿在化学品、可燃性气体或其他特殊物质附近使用闪光灯，这些物质在特殊情况下可能对闪光灯发出的瞬间强光敏感，有可能导致火灾或电磁干扰。在这些场合下，请注意相关警告标识。
- ▲ 本产品不能防水，在雨天及潮湿环境下请注意防水。
- ▲ 若发生任何故障，请立即关闭闪光灯电源。

01	前言
01	警告
03	部件名称
	机身
	控制面板
	固定支架
	标配物品
	可选购附件
05	安装
	安装柔光罩
	安装相机
	安装伞孔支架
06	电池盒
	特性
	注意事项
	装卸电池
	电池电量指示
07	使用闪光灯
	电源管理
	功率选择
	M普通模式
	S1光控模式
	S2光控模式
	RPT频闪模式
	⚡ 高速同步模式
	LED灯控制
	蜂鸣控制
	无线控制功能
	同步插孔触发
	PC端口同步触发
10	保护功能
11	规格参数
11	维护保养

部件名称

机身

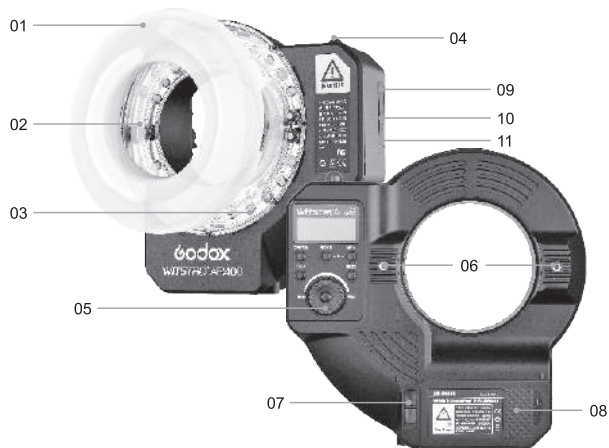

- (01) 柔光罩 (02) 闪光灯管 (03) LED灯珠 (04) 光控接收器 (05) 控制面板
(06) 支架固定螺孔 (07) 电池盒锁件 (08) 电池盒 (09) 无线控制插座
(10) 同步插孔 (11) PC插座

控制面板



- (12) LCD显示屏
(13) 电量指示灯
(14) LED灯控制按钮
(15) BUZZ蜂鸣开关
(16) MODE模式选择按钮
(17) SET设置按钮
(18) ON/OFF电源开关
(19) TEST试闪按钮/回电指示灯
(20) 调节旋钮

固定支架

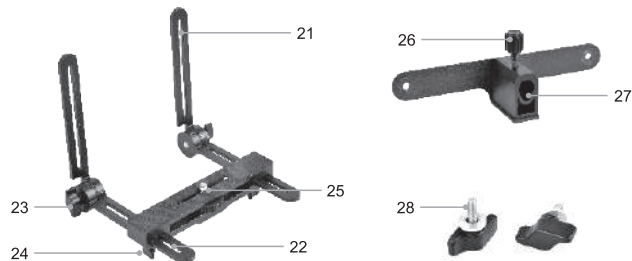

可折叠外拍灯支架

- (21) 高度导轨 (22) 深度导轨 (23) 角度固定旋钮 (24) 深度固定旋钮 (25) 相机固定旋钮

伞孔支架

- (26) 螺栓 (27) 伞孔 (28) 支架固定螺栓

标配物品包括:

闪光灯*1、可折叠外拍灯支架*1、伞孔支架*1、柔光罩*1、充电器*1、锂电池*1、说明书*1

可选购附件

可搭配本公司以下摄影附件使用，以获得最佳的拍摄效果和使用体验：
FT-16遥控器、反光伞、灯架等。



安装

装卸柔光罩

- 1、将柔光罩凸起边缘分别对准机身的凹陷部分，按紧；
- 2、握住环形闪光灯边缘，轻轻揭起柔光罩，即可卸下。



安装相机

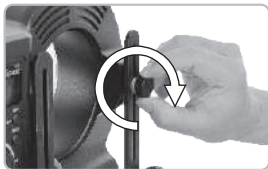

- 1、将高度导轨(21)对准灯体背面的支架固定螺孔(6)，两端各旋入一枚支架固定螺栓(28)，拧紧；

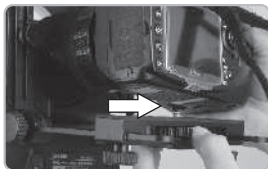

- 2、将相机固定旋钮(25)旋入相机的三脚架安装孔，拧紧；



- 3、调节角度固定旋钮(23)，使相机镜头头穿过环形灯圆心。

安装伞孔支架

- 1、将伞孔支架的两端对准灯体背面的支架固定螺孔(6)，两端各旋入一枚支架固定螺栓(28)，拧紧；
- 2、插入摄影伞；
- 3、旋紧螺栓固定摄影伞。



电池盒

特性

- 1、本品采用聚合物锂电池，使用寿命长；
- 2、安全可靠，内置电路有过充保护、过放保护、过流保护、短路保护；
- 3、使用标配充电器，电池充电时间只需3.5小时左右。

注意事项

- 1、避免正负极短路；
- 2、电池盒没有防水功能，不要把电池浸泡在雾、水中；
- 3、放置于儿童不易接触的地方；
- 4、电池充电不要放置超过24小时；
- 5、应把电池盒置于凉爽、干燥及通风的地方存储；
- 6、不要靠近和放置电池于火中；
- 7、使用报废的电池请按当地的规定处理
- 8、不要在充电的时候引闪光灯。
- 9、如果电池超过3个月不使用，请对电池进行额外充电。

装卸电池

安装：(1)主机与电池盒相扣；

(2)电池盒往左推正，听到“嗒”声即已锁紧。

拆卸：(1)下推“电池盒锁件”；

(2)按住电池盒往右推出即可卸下。



电池电量指示：

电量	电量符号指示	引闪次数(档位1/1)
电量≥25%	不显示	约100~400
7% < 电量 < 25%	显示	约30~100
电量≤7%	闪烁	约<30

注：开启LED灯时，会拉低电池电压，此时电量指示灯无法准确体现电池电量。

使用闪光灯

1. 电源管理

长按2秒ON/OFF电源开关(18)可控制AR400的打开和关闭。长期不使用时请关闭电源盒。

2. 功率选择

您可以在1/128功率至1/1全功率间以1/3档为增量设置闪光输出。为获得正确的闪光曝光，请使用手持的闪光测光表确定所需的闪光输出。

旋转调节旋钮(20)可以调节闪光输出，调节规则如下：

减小闪光输出指数→

1/1	1/1-0.3	1/1-0.7	1/2	1/2-0.3	1/2-0.7	1/4	...	OF
	1/2+0.7	1/2+0.3		1/4+0.7	1/4+0.3		...	

←增加闪光输出指数

当显示屏显示“OF”时，表示闪光无输出，即不能引闪。



当显示屏显示“OF”时，表示闪光无输出，即不能引闪。

3. M普通模式

通过按MODE模式选择按钮(16)，可以使闪光灯进入M模式。M模式下，闪光灯可以安装到相机或触发器热靴上进行引闪。拍摄时，您只需要设定闪光输出，调整相机并按下快门，闪光灯会在相机同步信号下进行闪光。此模式下光控关闭。

4. S1光控模式

通过按MODE模式选择按钮(16)，可以使闪光灯进入S1模式。S1模式下，闪光灯可作为副灯使用，创造多种照明效果，适用于手动闪光环境。它会与主闪光灯的第一次闪光同步触发闪光，效果与使用无线引闪器一致。

5. S2光控模式

通过按MODE模式选择按钮(16)，可以使闪光灯进入S2模式。S2模式下，可以做副灯使用，适用于TTL闪光环境。具有防预闪功能，使用带一次预闪功能的相机能用光控实现同步拍摄。它会与主闪光灯的第二次闪光同步触发闪光，即2次光控引闪。

6. RPT频闪模式

通过按MODE模式选择按钮(16)，可以使闪光灯进入RPT模式。RPT模式下，使用频闪闪光，可以发出一系列快速的闪光。它可以在一张照片上拍摄移动物体的多个图像。

您可以设置闪光频率(每秒的闪光次数，以Hz表示)、闪光次数和闪光输出。

设置步骤：

6.1 按下MODE模式选择按钮(16)以显示“RPT”。

6.2 按下SET设置按钮(17)选择调节项目(闪烁)。

6.3 旋转调节旋钮(20)调整数值。

计算快门速度：

在频闪闪光过程中，到闪光停止为止快门应保持开启状态。使用下面的公式计算快门速度，然后用相机进行设置。

闪光次数 / 闪光频率 = 快门速度

例如，如果闪光次数是10，闪光频率是5Hz，快门速度则至少为2秒。

注：

- 反光很强的被摄体在暗背景前使用频闪闪光更加有效。
- 推荐使用三脚架、遥控开关和外置电源。
- 闪光输出为1/1或1/2时不能设置频闪闪光。
- 频闪闪光时也可以使用“buLb”。



为防止闪光灯头过热并损坏，请勿执行连续10次以上的频闪闪光连拍。

最大频闪闪光次数：

功率 \ Hz	1	2	3	4	5	6	7
1/4	30	2	2	2	2	2	1
1/8	50	4	2	2	2	2	2
1/16	70	70	7	4	3	3	3
1/32	80	80	80	16	8	6	5
1/64	99	99	99	99	99	99	25
1/128	99	99	99	99	99	99	99

功率 \ Hz	8	9	10-11	12-13	13-15	15-19	20-99
1/4	1	1	1	1	1	1	1
1/8	2	2	2	2	2	2	2
1/16	2	2	2	2	2	2	2
1/32	5	4	4	3	3	3	3
1/64	15	10	6	6	5	5	5
1/128	99	99	99	99	99	36	20

7. 高速同步模式

同时按MODE模式选择按钮(16)和LED灯控制按钮(14)可以使闪光灯进入  模式。

如果想跳出  高速同步模式请按MODE模式选择按钮。

使用高速同步(FP闪光)，您可以在所有的快门速度下同步使用闪光灯。

高速同步闪光在使用光圈优先对人像进行填充闪光时特别方便。

注：

。高速同步模式必须配合高速同步遥控器(比如神牛产品CELLS II)才可实现其功能。

。插在相机热靴上无法实现高速同步功能。



为防止闪光灯过热并损坏，在1/1档位时连续执行10次高速同步闪光后，系统会自动进入热保护，回电时间会比正常延迟10秒。

高速同步模式下，激活热保护功能的连续闪光次数：

功率	次数(大约值)
1/1	10
1/2	15
1/4	20
1/8	30
1/16	40
1/32	50

8.LED灯控制

通过按LED灯控制按钮(14)可以控制LED灯：Off→30%→70%→100%→Off.....

LED灯点亮时，显示屏的  符号会显示。

档位	自动关闭时间
100%	5分钟
70%	10分钟
30%	15分钟

9. 蜂鸣控制

本机带有蜂鸣功能，可通过按BUZZ蜂鸣开关(15)来控制。

蜂鸣器处于打开状态时，显示屏的  符号会显示。

10. 无线控制功能

。闪光灯内置无线控制插座，配合特定遥控器使用，您可以实现对闪光灯的无线控制。

。将神牛FT系列遥控器的接收端插入“无线控制插座(9)”，手持遥控器发射端，即可远程控制

闪光灯的功率开关和大小、造型灯开关、蜂鸣器开关、闪光灯触发等。您也可以将发射端置于相机热靴上，通过相机快门来进行同步引闪。

- 。更多遥控器的使用方法，请查阅FT系列遥控器的说明书。
- 。AR400接收到无线信号时，显示屏会显示  符号。

11. 同步插孔触发

同步插孔(10)规格为Φ3.5mm，此处可插入同步线或者触发器触发插头对闪光灯进行同步引闪。

12. PC端口同步触发

用连闪线将相机与AR400的PC插座(11)连接，可实现闪光灯与快门同步触发闪光。

保护功能

热保护：

- 。为防止闪光灯过热并损坏，请勿在1/1功率时进行超过40次的快速连续闪光。40次连续闪光后，要让闪光灯至少冷却10分钟。
- 。如您在进行超过40次连续闪光后马上继续进行更多次闪光，内部的防过热功能可能会被激活，使充电时间变为10至15秒。如果发生这种现象，请让闪光灯冷却约10分钟，闪光灯便会恢复正常。
- 。热保护启动后，显示屏上会显示  符号。

连续闪光保护对应表：

功率	次数(大约值)
1/1	40
1/2+0.7	60
1/2+0.3	80
1/2	100
1/4(+0.3/+0.7)	200
1/8(+0.3/+0.7)	300
1/16(+0.3/+0.7)	400
1/32(+0.3/+0.7)	400
1/64(+0.3/+0.7)	500
1/128(+0.3/+0.7)	500

规格参数

型号	AR400
电池盒	AR-B4500(锂电池10.8V/4000mAh)
闪光能量	400WS
闪光指数(m ISO 100)	36
闪光次数(全功率1/1)	约400次
M/S1/S2模式档位	1/128~1/1
RPT模式档位	1/128~1/4
高速同步模式档位	1/32~1/1
回电时间	0.05~3s
色温	5600K±200K
闪光持续时间	1/300s—1/10000s
闪光触发控制方式	3.5mm/PC同步插孔, 光控感应, 试闪按钮, 无线控制插座
LED光照度100%(LUX)	440(0.5 米)
体积	22.5*23*7cm
净重(含电池)	约1.4kg

维护保养

- 闪光灯在工作时, 如发现异常, 应立即关掉电源, 查明原因。
- 灯体应避免震动, 平时注意表面除尘。
- 灯体稍有发热为正常现象。无特别需要时, 勿连续引闪。
- 除灯管消耗品可由用户用原厂配置的灯管自行装卸更换外, 闪光灯的所有维修概由本厂指定可供原厂配件之维修部负责。
- 一年保修, 由于灯管为消耗品, 不在一年保修范围。
经发现, 擅自检修此闪光灯的, 将取消闪光灯之一年保修期, 维修需要收取相关费用。
清洁本产品或更换灯管时, 请切断闪光灯电源。
- 如果本品出现故障或者被水淋湿, 唯有在专业人员维修后可继续使用。
- 如有外观变化或技术更改, 恕不另行通知。

Godox

威客大功率环形闪光灯
Powerful Ring Flash

WITSTRO⁺AR400



使用手册

INSTRUCTION MANUAL

Before using this product

Please read this user manual carefully in order to ensure your safety and the proper operation of this product. Keep for future reference.

Thank you for purchasing this product.

Powerful Ring Flash AR400 is the perfect choice for portrait photography, product shooting, photojournalistic and video recording, etc. It can function as ring flash, outdoor flash, as well as LED video light to offer stable light source with high power and great portability. This ring flash offers:

- 400Ws high power, GN36(m ISO 100)
- Pro 4000mAh Li-ion battery—0.05-2.8s recycle time—approx. 400 full power pops
- 22 steps of precise power control (1/1~1/128)
- Stable color temperature at 5600±200K
- Supports for Multi flash modes, High-Speed Sync, etc.
- Use designed remote control to adjust flash parameters and trigger the flash
- Set as LED video light to offer continuous lighting source



Warning

- ▲ Always keep this product dry. Do not use in rain or in damp conditions.
- ▲ Do not disassemble. Should repairs become necessary, this product must be sent to an authorized maintenance center.
- ▲ Keep out of reach of children.
- ▲ Stop using this product if it breaks open due to extrusion, falling or strong hit. Otherwise, electric shock may occur if you touch the electronic parts inside it.
- ▲ Do not fire the flash directly into the eyes (especially those of babies) within short distances. Otherwise visual impairment may occur.
- ▲ Do not use the flash unit in the presence of flammable gases, chemicals and other similar materials. In certain circumstance, these materials may be sensitive to the strong light emitting from this flash unit and fire or electromagnetic interference may result.
- ▲ Do not leave or store the flash unit if the ambient temperature reads over 50°C. Otherwise the electronic parts may be damaged.
- ▲ Turn off the flash unit immediately in the event of malfunction

13	Forward
13	Warning
15	Name of Part
	Body
	Control Panel
	Brackets
	Included Accessories
	Separately Sold Accessories
17	Installation
	Installing the Diffusion Cover
	Installing the Camera
	Installing the Umbrella Bracket
18	Battery Pack
	Features
	Cautions
	Loading and Unloading the Battery Pack
	Battery Level Indication
19	Using the Flash
	Power Management
	Flash Output
	M Mode
	S1 Mode: S1 Slave Triggering Mode
	S2 Mode: S2 Slave Triggering Mode
	RPT Mode: Stroboscopic Flash
	⚡ High-Speed Sync Triggering
	LED Light Control
	Buzz Function
	Wireless Control Function
	Sync Triggering
	PC Sync Triggering
22	Protection Function
23	Technical Data
23	Maintenance

Name of Parts

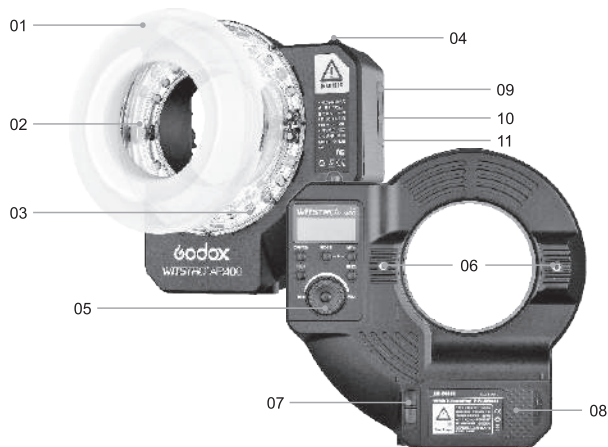
• Body



- (1) Diffusion Cover (2) Flash Tube (3) LED Beads (4) Light Sensor (5) Control Panel
 (6) Bracket Mounting Hole (7) Battery Locking Key (8) Battery Pack
 (9) Wireless Control Port (10) Sync Cord Jack (11) PC Sync Socket

• Control Panel

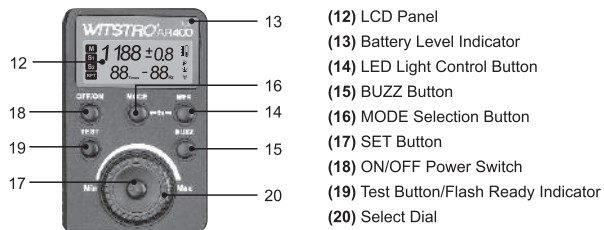

• Brackets

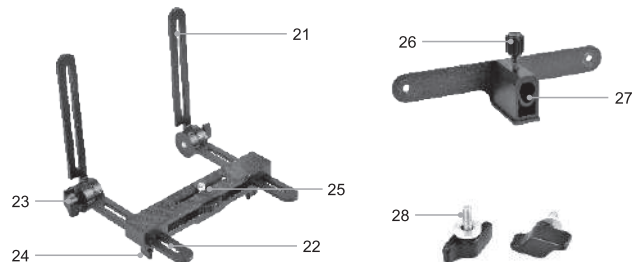

Folding Light Bracket

- (21) Height Guide Rail (22) Depth Guide Rail (23) Angle Adjusting Knob
 (24) Depth Adjusting Knob (25) Camera Adjusting Knob

Umbrella Bracket

- (26) Bolt (27) Umbrella Input (28) Bracket Mounting Bolts

• Included Accessories

- Ring flash*1 Folding light bracket*1 Umbrella bracket*1 Diffusion cover*1
 Battery charger*1 Li-ion Battery pack*1 Instruction Manual*1

• Separately Sold Accessories

- The product can be used in combination with the following accessories sold separately, so as to achieve best photography effects:
 FT-16 Remote Control, Photographic Umbrella, Light Stand, etc.

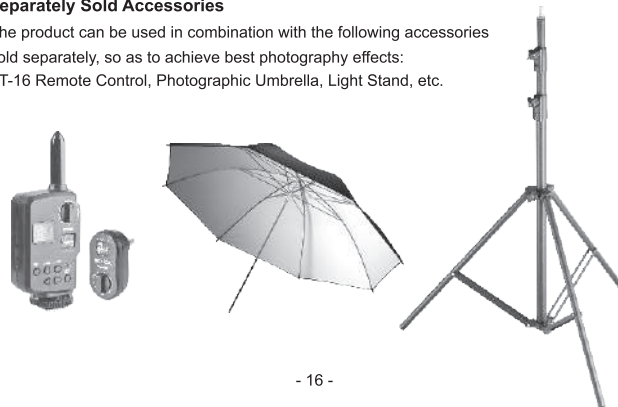

Installation

Installing the Diffusion Cover

1. Put the diffusion cover on the flash body and make the claws of the cover correctly fall into the hollow periphery of the body.
2. The diffusion cover can be detached by lifting it lightly.



Installing the Camera

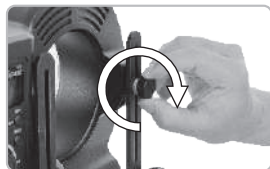

1. Aim the Height Guide Rail (21) at the Bracket Mounting Hole (6) of the flash body. Then, screw the two Bracket Mounting Bolts (28) into the Bracket Mounting Hole (6) and tighten them.

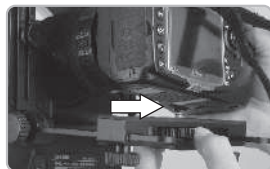

2. Screw the Camera Adjusting Knob (25) into the camera's tripod socket and tighten it.



3. Adjust the Angle Adjusting knob (23) to let the camera lens pass through the ring flash.

Installing the Umbrella Bracket

1. Aim the umbrella bracket at the Bracket Mounting Hole (6) of the flash body. Then, screw the two Bracket Mounting Bolts (28) into the Bracket Mounting Hole (6) and tighten them.
2. Insert the photo umbrella.
3. Tighten the bolt to fix the photo umbrella.



Battery Pack

Features

1. This flash unit uses Li-ion polymer battery which has long runtime. The available charge-and-discharge times are 500.
2. It is reliably safe. The inner circuit is against overcharge, overdischarge, overcurrent, and short circuit.
3. Take only 3.5 hours to fully charge the battery by using the standard battery charger.

Cautions

1. Do not short circuit.
2. Do not expose to rain or immerse into water. This battery is not water proof.
3. Keep out of reach of children.
4. No over 24 hours' continuous charging.
5. Store in dry, cool, ventilated places.
6. Do not put aside or into fire.
7. Dead batteries should be disposed according to local regulations.
8. Do not fire the flash when charging.
9. If the battery had ceased using for over 3 months, please a full recharge.

Loading and Unloading the Battery Pack

Loading: (1) Put the battery pack into the battery compartment. (2) Push the battery pack to the left until it is locked with a click sound.

Unloading: (1) Push the Battery Locking Key (7) downward. (2) Push the battery pack to the right to unload it.



Battery Level Indication

Battery Level	Battery Level Indication	Flash Times (1/1 step)
Battery Level ≥ 25%	Not Displayed	Approx. 100~400
7% < Battery Level < 25%	Displayed	Approx. 30~100
Battery Level ≤ 7%	Blinking	Approx. <30

Note: When the LED light is on, the battery voltage is lower and the battery level indicator cannot display the correct amount.

Using the Flash

1. Power Management

Press ON/OFF Power Switch for 2 seconds to power the ring flash on or off. Turn off if it will not be used for an extended period of time.

2. Power Control

The flash output is adjustable from 1/1 full power to 1/128th power in 1/3rd step increments. To obtain a correct flash exposure, use a hand-held flash meter to determine the required flash output.

Turn the select dial to adjust the flash output and the rules are shown in the following table:

Figures displayed when reducing flash output level→

1/1	1/1-0.3	1/1-0.7	1/2	1/2-0.3	1/2-0.7	1/4	...	OF
	1/2+0.7	1/2+0.3		1/4+0.7	1/4+0.3		...	

←Figures displayed when increasing flash output level



When the LCD panel shows "OF", it means that there is no flash output and the flash cannot be fired.

3. M Mode

Press MODE Selection Button (16) to enter M mode. In this mode, you can set the flash unit onto your camera hot shoe or your trigger hot shoe for firing. During shooting, adjust the power output and press the camera shutter, then the camera flash will fire a flash under the camera synchronous signal. In this mode, the light sensor is off.

4. S1 Mode: S1 Slave Triggering Mode

Press Mode Selection Button (16) to enter S1 mode. In this mode, the flash unit can function as a slave flash for creating multiple lighting effects. It is respectively applicable to manual flash environment.

In S1 mode, the flash unit will fire synchronously when the master flash fires, the same effect as that by the use of radio triggers.

5. S2 Mode: S2 Slave Triggering Mode

Press Mode Selection Button (16) to enter S2 mode. In this mode, the flash unit can function as a slave flash for creating multiple lighting effects. It is respectively applicable to TTL system.

In S2 mode, the flash unit will ignore a single "preflash" from the master flash and will only fire in response to the second, actual flash from the master.

6. RPT Mode: Stroboscopic Flash

Press Mode Selection Button (16) to enter RPT mode. With stroboscopic flash, a rapid series of flashes is fired. It can be used to capture multiple images of a moving subject in a single photograph.

You can set the firing frequency (number of flashes per sec. expressed as Hz), the number

of flashes, and the flash output.

For setting procedures, see the following:

- Press the Mode Selection Button (16) so that "RPT" is displayed.
- Press Set Button (17) to select the item to be set. The item blinks.
- Rotate Select Dial (20) to set a desired number.

Calculating the Shutter Speed

During stroboscopic flash, the shutter remains open until the firing stops. Use the following formula to calculate the shutter speed and set it with the camera.

Number of flashes / Firing frequency = Shutter speed

For example, if the number of flashes is 10 and the firing frequency is 5 Hz, the shutter speed should be at least 2 sec.

Note:

- Stroboscopic flash is most effective with a highly reflective subject against a dark background.
- Using a tripod, a remote switch, and an external power source is recommended.
- A flash output of 1/1 or 1/2 cannot be set for stroboscopic flash.
- Stroboscopic flash can be used with "buLb".





To avoid overheating and deteriorating the flash head, do not use stroboscopic flash more than 10 times in succession.

Maximum Stroboscopic Flashes:

Flash Output \ Hz	1	2	3	4	5	6	7
1/4	30	2	2	2	2	2	1
1/8	50	4	2	2	2	2	2
1/16	70	70	7	4	3	3	3
1/32	80	80	80	16	8	6	5
1/64	99	99	99	99	99	99	25
1/128	99	99	99	99	99	99	99

Flash Output \ Hz	8	9	10-11	12-13	13-15	15-19	20-99
1/4	1	1	1	1	1	1	1
1/8	2	2	2	2	2	2	2
1/16	2	2	2	2	2	2	2
1/32	5	4	4	3	3	3	3
1/64	15	10	6	6	5	5	5
1/128	99	99	99	99	99	36	20

7. Hi-Speed Sync Triggering

To enter  mode, press both Mode Selection Button (16) and LED Light Control Button(14). Press Mode Selection Button (16) again to exit  mode.

In  hi-speed sync triggering mode, you can use a hi-speed sync trigger to have your flash unit synchronize with all shutter speeds of cameras(max. 1/8000 second, up to your camera). This is convenient when you want to use aperture- priority for fill-flash portraits.

Note:

- Hi-speed sync triggering mode is effective only when the flash unit is used together with hi-speed sync trigger, e.g., Godox Cells II transceiver.
- Hi-speed sync triggering mode is not available when the flash unit is mounted onto the camera hotshoe.



To avoid overheating or deteriorating the flash head, the over-temperature protection function will be activated automatically after 10 continuous high-speed flashes and the recycle time becomes 10s longer.

Number of flashes that will activate over-temperature protection in high-speed sync triggering mode:

Power Output Level	Number of Flashes (Approx.)
1/1	10
1/2	15
1/4	20
1/8	30
1/16	40
1/32	50

8. LED Light Control

Press the LED Light Control Button (14) to control LED light: Off→30%→70%→100%→Off.....

When the LED light is turned on, the  icon is shown on the LCD display.

Step	Time of Auto off
100%	5 min.
70%	10 min.
30%	15 min.

9. Buzz Function

The buzz function can be controlled by pressing BUZZ Button (15).

When the buzzer is turned on,  is shown on the LCD display.

10. Wireless Control Function

- The flash unit is built in with a Wireless Control Port (9) so that you can wirelessly control the on-and-off of your flash, modeling lamp and buzzer, as well as adjust the flash output

level, etc.

- To control the flash wirelessly, you need a Godox FT series remote control set (on-camera and on-flash transceiver). Insert its receive end into the Wireless Control Port (9) on the flash and insert the transmit end into the camera hot shoe. Settings made on the hotshoe-mounted transceiver and receive ends will be wirelessly communicated to the flash. Then you can press the camera shutter-release button to trigger the flash.
- For full instructions on the use of FT series remote control, see its user manual.
- When the flash unit receives wireless signals,  is shown on the LCD display.

11. Sync Triggering

The Sync Cord Jack (10) is a Φ 3.5mm plug. Insert a trigger plug here and the flash will be fired synchronously with the camera shutter.

12. PC Sync Triggering

Insert one end of a PC sync cable into the PC Sync Socket (11) of the flash unit and the other end into the PC Sync Socket on the camera. The flash unit will fire when the camera's shutter-release button is pressed.



Protection Function

Over-Temperature Protection

- To avoid overheating and deteriorating the flash head, do not fire more than 40 continuous flashes in fast succession at 1/1 full power. After 40 continuous flashes, allow a rest time of at least 10 minutes.
- If you fire more than 40 continuous flashes and then fire more flashes in short intervals, the inner over-temperature protection function may be activated and make the recycling time about 10 to 15 seconds. If this occurs, allow a rest time of about 10 minutes, and the flash unit will then return to normal.
- When the over-temperature protection is started,  is shown on the LCD display.

Number of flashes that will activate over-temperature protection:

Power Output Level	Number of Flashes (Approx.)
1/1	40
1/2+0.7	60
1/2+0.3	80
1/2	100
1/4(+0.3/+0.7)	200
1/8(+0.3/+0.7)	300
1/16(+0.3/+0.7)	400
1/32(+0.3/+0.7)	400
1/64(+0.3/+0.7)	500
1/128(+0.3/+0.7)	500

Technical Data

Model	AR400
Battery	AR-B4500(Li-ion battery 10.8V/4000mAh)
Max Power(Ws)	400Ws
Guide Number(m ISO 100)	36
Full Power Flashes(1/1)	Approx.400 times
M/S1/S2 Mode	1/128~1/1
RPT Mode	1/128~1/4
High-Speed Sync	1/32~1/1
Recycle Time	0.05~3s
Color Temperature	5600K±200K
Flash Duration	1/300s-1/10000s
Triggering Method	3.5mm/PC Sync cord, Slave triggering, Test button, Wireless control port
100% LED Brightness(LUX)	440 (0.5 m)
Dimension	22.5*23*7cm
Net Weight (with battery)	Approx.1.4kg

Maintenance

- Shut down the device immediately should abnormal operation be detected.
- Avoid sudden impacts and the lamp should be dedusted regularly.
- It is normal for the flash tube to be warm when in use. Avoid continuous flashes if unnecessary.
- Maintenance of the flash must be performed by our authorized maintenance department which can provide original accessories. The flash-tube is user-replaceable. Replacement tubes can be obtained from the manufacturer.
- This product, except consumables e.g. flash tube, is supported with a one-year warranty.
- Unauthorized service will void the warranty.
- If the product had failures or was wetted, do not use it until it is repaired by professionals.
- Disconnect the power when cleaning the unit or when changing the flashtube.
- Changes made to the specifications or designs may not be reflected in this manual.

Declaration of Conformity
GODOX Photo Equipment Co.,Ltd. hereby declares that this equipment are in compliance with the essential requirements and other relevant provisions of Directive2014/35/EU,2014/30/EU. They are allowed to be used in all EU member states.

For more information of DoC, Please click this web link:

https://www.godox.com/DOC/Godox_AR400_DOC.pdf

产品保修

尊敬的用户，本保修卡是申请保修服务的重要凭证，请您配合销售商填写并妥善保管，谢谢！

产品信息	型号	产品条码
用户信息	姓名	联系电话
	通信地址	
销售商信息	名称	
	联系电话	
	通信地址	
	销售日期	
备注		

注：此表应由销售商盖章确认。

如何获得保修服务

您可直接与产品销售商或授权服务机构联系，也可拨打神牛产品售后服务电话，与我们联系，由我们的服务人员为您安排服务。申请保修时，您应提供有效的保修卡作为保修凭证，方可获得保修。如您不能提供有效的保修卡，则在我们可确认产品或部件属于保修范围的情况下，也可以为您提供保修，但这不作为我们的义务。

不适用保修的情况

如产品存在下列情况，本文件项下的保证和服务将不适用 ①产品或部件超过相应保修期；②错误或不适当使用、维护或保管导致的故障或损坏，如：不当搬运；非按产品合理预期用途使用；不当插拔外接设备；跌落或外力挤压；接触或暴露于不当温度、溶剂、酸碱、水浸或潮湿环境；③由非神牛授权机构或人员安装、修理、更改、添加或拆卸造成的故障或损坏；④产品或部件原有识别信息被修改变更或删除；⑤无有效保修卡；⑥使用非法授权、非标准或非公开发行的软件造成的故障或损坏；⑦因不可抗力或意外事件造成的故障或损坏；⑧其他非因产品本身质量问题导致的故障或损坏。遇上述情况，您应向相关责任方寻求解决，神牛对此不承担任何责任。因非在保修期或保修范围内的部件、附件或软件导致产品不能正常使用的，不是保修范围内的故障。产品使用过程中正常的脱色，磨损和消耗，不是保修范围内的故障。

产品保修和服务支持信息

产品的保修期和服务类型按以下《产品保修信息》执行：

产品类别	选件名称	保修期(月)	保修服务类型
部件	电路板	12	客户送修
	电池	3	客户送修
	充电器、电源线，同步线等带电性能的部件。	12	客户送修
其他	如闪光灯管、造型灯泡、外壳、保护罩、锁紧装置、包装等。	无	无保修

神牛产品售后服务电话 0755-29609320-8062

适用产品

本文件适用于相关《产品保修信息》(见后面说明)所列产品，其他非属此范围的产品或部件(如促销品、赠品及其他出厂后附加的部件等)不在此保修承诺内。

保修期

产品及部件的相应保修期按相关的《产品保修信息》执行。保修期自产品首次购买日起算，购买日以购买产品时保修卡登记日期为准。

Warranty

Dear customers, as this warranty card is an important certificate to apply for our maintenance service, please fill in the following form in coordination with the seller and safe-keep it. Thank you!

Product Information	Model	Product Code Number
Customer Information	Name	Contact Number
	Address	
Seller Information	Name	
	Contact Number	
	Address	
	Date of Sale	
Note:		

Note: This form shall be sealed by the seller.

Applicable Products

The document applies to the products listed on the **Product Maintenance Information** (see below for further information). Other products or accessories (e.g. promotional items, giveaways and additional accessories attached, etc.) are not included in this warranty scope.

Warranty Period

The warranty period of products and accessories is implemented according to the relevant Product Maintenance Information. The warranty period is calculated from the day(purchase date) when the product is bought for the first time, And the purchase date is considered as the date registered on the warranty card when buying the product.

How to Get the Maintenance Service

If maintenance service is needed, you can directly contact the product distributor or authorized service institutions. You can also contact the Godox after-sale service call and we will offer you service. When applying for maintenance service, you should provide valid warranty card. If you cannot provide valid warranty card, we may offer you maintenance service once confirmed that the product or accessory is involved in the maintenance scope, but that shall not be considered as our obligation.

Inapplicable Cases

The guarantee and service offered by this document are not applicable in the following cases: ①. **The product or accessory has expired its warranty period;** ②. **Breakage or damage caused by inappropriate usage, maintenance or preservation, such as improper packing, improper usage, improper plugging in/out external equipment, falling off or squeezing by external force, contacting or exposing to the improper temperature, solvent, acid, base, flooding and damp environments, etc;** ③. **Breakage or damage caused by non-authorized institution or staff in the process of installation, maintenance, alternation, addition and detachment;** ④. **The original identifying information of product or accessory is modified, alternated, or removed;** ⑤. **No valid warranty card;** ⑥. **Breakage or damage caused by using illegally authorized, nonstandard or non-public released software;** ⑦. **Breakage or damage caused by force majeure or accident;** ⑧. **Breakage or damage that could not be attributed to the product itself.** Once met these situations above, you should seek solutions from the related responsible parties and Godox assumes no responsibility. The damage caused by parts, accessories and software that beyond the warranty period or scope is not included in our maintenance scope. The normal discoloration, abrasion and consumption are not the breakage within the maintenance scope.

Maintenance and Service Support Information

The warranty period and service types of products are implemented according to the following **Product Maintenance Information**:

Product Type	Name	Maintenance Period(month)	Warranty Service Type
Parts	Circuit Board	12	Customer sends the product to designated site
	Battery	3	Customer sends the product to designated site
	Electrical parts e.g.battery charger, power cord, sync cable, etc.	12	Customer sends the product to designated site
Other Items	Flash tube, modeling lamp, lamp body, lamp cover, lockingdevice, package, etc.	No	Without warranty

Godox After-sale Service Call **0755-29609320-8062**