



神牛微信公众号
Follow Wechat Official Account

合格证
QC PASS

深圳市神牛摄影器材有限公司

地址: 深圳市宝安区福海街道塘尾社区耀川工业区厂房2栋
电话: 0755-29609320(8062) 传真: 0755-25723423 邮箱: godox@godox.com

GODOX Photo Equipment Co., Ltd.

Add: Building 2, Yaochuan Industrial Zone, Tangwei Community, Fuhai Street, Bao'an District,
Shenzhen 518103, China Tel: +86-755-29609320(8062) Fax: +86-755-25723423
E-mail: godox@godox.com

godox.com

Made in China



Godox

多功能超心型电容枪式麦克风
Multi-Functional Supercardioid Condenser Shotgun Microphone

VDS-M3

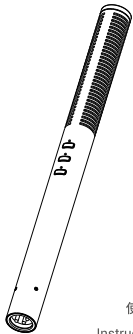

使用手册
Instruction Manual

前言

感谢购买神牛产品!

VDS-M3是一款内置锂电池的超心型枪式麦克风,可提供220小时以上的运行时间,方便 USB 充电。充满约需2.5个小时。USB-C充电线使充电简单方便,这意味着麦克风可以通过电脑,充电宝,甚至你的车充电。此产品常用于影视、专业采访录制。请仔细阅读说明书,以便正确操作。充分发挥本产品的优越性能。

产品特点

- 超心型指向,离轴,低音染
- 广播音质
- 低噪音电路
- 革命性的声学设计
- 轻巧灵动
- 可调节的高通滤波器、增益控制、高频增强
- 贴心配件,稳定又降噪

警告

- ⚠ 请勿私自拆卸产品!产品如出现故障须由本公司或授权的维修人员进行检查维修。
- ⚠ 请保持干燥!请勿用湿手接触产品,亦不可将产品浸入水中或暴露于雨中。
- ⚠ 请勿让儿童接触本产品!
- ⚠ 请勿在易燃易爆环境中使用!在这些场合下,请注意相关警告标识。
- ⚠ 请勿放置在超过50°C的高温环境中!
- ⚠ 请仔细阅读并遵守由厂商提供的警告或指示!

产品结构

1. 电源/-10dB衰减按钮
2. 高频增强按钮
3. 高通滤波按钮
4. 指示灯3
5. 指示灯2
6. 指示灯1
7. TYPE-C充电口
8. 卡侬插口
9. 调节支架
10. 防风海绵

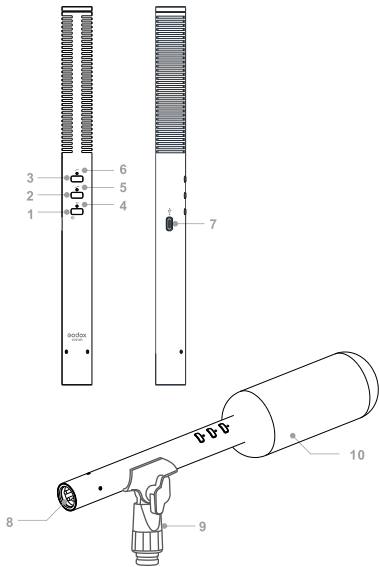

产品尺寸

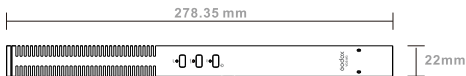

供电

VDS-M3具备两种方式供电:卡农口供电和内置锂电池供电

充电

USB充电:将麦克风的 USB-C 充电线一端连接电脑、充电宝或车辆,一端连接麦克风便可进行充电。锂电池容量为2000mAh,充满约需2.5个小时。

开关机

使用卡农口供电

开机:自动检测到48V幻象电源有电流输入时,长枪麦克风自动启动工作,此时 ⏻ 电源/-10dB衰减按钮上方指示灯3显现长亮蓝色状态。

关机:拔下48V幻象电源供电线则瞬间进入关机状态(指示灯熄灭);声卡48V供电按钮关闭则延迟2S进入关机状态(指示灯熄灭)。

使用锂电池供电

开机:长按2秒 ⏻ 电源/-10dB衰减按钮,长枪麦克风启动工作,此时 ⏻ 电源/-10dB衰减按钮上方指示灯3呈现长亮蓝色状态。

关机:长按2秒 ⏻ 电源/-10dB衰减按钮,长枪麦克风关闭工作,此时 ⏻ 电源/-10dB衰减按钮上方指示灯3呈现灰暗状态。

按键说明

• ↗ 高通滤波按钮

短按 ↗ 高通滤波按钮,上方指示灯1呈现灭掉状态,则为普通模式。按钮上方指示灯1呈现绿色状态时,则为75Hz模式。高通滤波功能可过滤低于75Hz的低频信号,减少来自风、交通和其他环境声中的低频噪声。

• ↘ 高频增强按钮

短按 ↘ 高频增强按钮,按钮上方指示灯2呈现灰暗状态,则为正常模式,按钮上方指示灯2呈现绿色状态,则为高频增强模式。高频增强功能可以增强声音细节和清晰度-在使用防风罩时尤其有用。

• ⏻ 电源/-10dB衰减按钮

短按 ⏻ 电源/-10dB衰减按钮,按钮上方指示灯3呈现绿色状态,则为-10dB模式。-10dB音量衰减,用于在非常嘈杂环境下录音。

状态指示说明

关机充电:当麦克风处于关机状态,用USB充电线连接TYPE-C接口充电,此时 ⏻ 电源/-10dB衰减按钮上方指示灯3呈现黄闪状态,闪烁时间间隔1秒,当充满电时, ⏻ 电源/-10dB衰减按钮上方指示灯3呈现长亮黄色,默认停止充电。

开机充电:当麦克风处于开机状态,用USB充电线连接TYPE-C接口充电,此时 ⏻ 电源/-10dB衰减按钮上方指示灯3呈现红闪状态,闪烁时间间隔1秒。接着短按 ⏻ 电源/-10dB衰减按钮,即表示开启-10dB模式,按钮上方指示灯3指示红绿闪状态,闪烁时间间隔0.5S。当电池充满时, ⏻ 电源/-10dB衰减按钮上方指示灯3呈现长亮红色状态。当在开启-10dB模式状态下充满电, ⏻ 电源/-10dB衰减按钮上方指示灯3呈现红闪长亮绿色状态。

状态指示说明

低电量:当电池电量低于10%且处于-10dB模式时, 电源/-10dB衰减按钮上方显示灯3呈现为蓝绿闪烁状态, 闪烁时间间隔0.5S。当电池电量低于10%且没有处于-10dB模式中, 电源/-10dB衰减按钮上方指示灯3呈现为蓝色闪烁状态, 闪烁时间间隔1S。

频率响应图

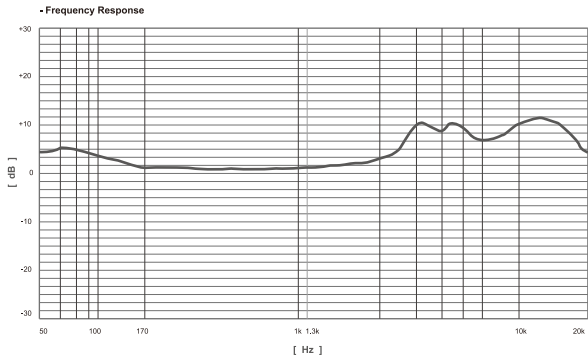

超心型指向

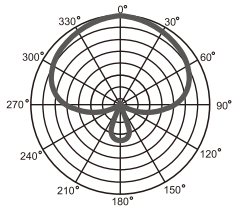

标配物品



麦克风×1



调节支架×1



USB-C 充电线×1



防风海绵×1



说明书×1

规格参数

型号	VDS-M3
拾音模式	超心型
充电电流	1.2A
频率范围	20Hz-20KHz
输出阻抗	200Ω
信噪比	75dB
灵敏度	-37dB±3dB
高通滤波器频率	75Hz
电池容量	2000mAh
工作环境温度	-10°C~50°C
整机尺寸	278mm*22mm
整机重量	183g

维护保养

避免跌落!如果受到强烈碰撞或震动,设备可能会发生故障;

保持干燥!本产品是非防水产品,如果将其浸入水中或放置于高湿度的环境中将可能发生故障。内部构造生锈可能会导致无法修理的损害。

避免温度骤变!温度的突变,诸如在寒冷天进出温暖的大楼将可能会使产品内部结露。为避免结露,请将本产品事先装入手提袋或塑料包内,以防温度突变。

远离强磁场!无线电广播发射机等设备产生的强静电或强磁场可能会干扰本产品正常工作。

Forward

Thank you for purchasing!

VDS-M3 Supercardioid Shotgun Microphone has a built-in lithium battery and 220 hours of runtime. Type-C USB cable offers convenient and quick charge in approximately 2.5 hours with computer, power bank or car. It can be used for audio recording in film, video and professional interview. Please read this manual carefully before using to make sure correct operation and exert the optimum function.

Product Features

- Supercardioid directivity, off-axis, low audio rendering
- Broadcast sound quality
- Low noise circuit
- Revolutionary acoustic design
- Lightweight and portable
- Adjustable high pass filter, precise gain control, high boost
- Standard accessories to ensure stable and noise reduction

Warning

- ⚠ Do not disassemble. Should repairs become necessary, this product must be sent to our Company or an authorized maintenance center.
- ⚠ Always keep this product dry. Do not use in rain or in damp conditions. Keep out of reach of children.
- ⚠ Do not use the microphone in the presence of flammable gas. In certain circumstance, please pay attention to the relevant warnings.
- ⚠ Do not leave or store the product if the ambient temperature reads over 50°C.
- ⚠ Read and follow all warnings and instructions provided by the manufacturer.

Product Structure

1. Power Switch/-10dB Pad Button
2. High Boost Button
3. High Pass Filter Button
4. Indicator Lamp 3
5. Indicator Lamp 2
6. Indicator Lamp 1
7. TYPE-C Jack Port
8. XLR Port
9. Direction Adjusting Bracket
10. Windscreen Foam

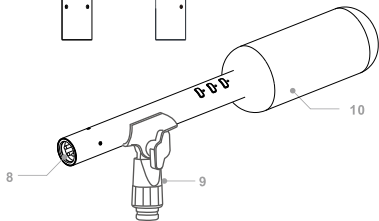

Dimension of Product

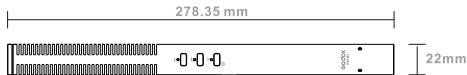

Power Supply

XLR power supply and built-in lithium battery power supply.

Charging

USB charging: Connect the microphone to computer, power bank or car with Type-C USB cable. The lithium battery has a capacity of 2000mAh, can be fully charged in approximately 2.5 hours.



ON/OFF



Powered by XLR

ON: When current input from the 48V phantom power is detected, the microphone starts working automatically, and the Indicator Lamp 3 above the  Power Switch/-10dB Pad Button will constant on blue.

OFF: Unplug the 48V phantom power cable, the microphone will shutdown immediately (Indicator Lamp 3 will turn off); while shutdown the microphone by using the power switch

button of 48V sound card will take approx. 2 seconds(Indicator Lamp 3 will turn off).

ON: Press and hold the  Power Switch/-10dB Pad Button for 2 seconds, the microphone starts working, and the Indicator Lamp 3 above the  Power Switch/-10dB Pad Button will constant on blue.

OFF: Press and hold the  Power Switch/-10dB Pad Button for 2 seconds, the microphone stops working, and the Indicator Lamp 3 above the  Power Switch/-10dB Pad Button will be grey.

Button Illustration

High Pass Filter Button

Short press the  High Pass Filter Button and the Indicator Lamp 1 above is off, the device is in regular mode. Press it again and the Indicator Lamp 1 above is green, then it is in 75Hz mode. The 75Hz high pass filter mode cuts frequencies below 75Hz to help mitigate wind noise and other low frequency rumble.

High Boost Button

Short press the  High Boost Button and the Indicator Lamp 2 above is grey, it is in regular mode. Press it again and the Indicator Lamp 2 above is green, then it is in high boost mode. The high boost can enhances clarity and detail in your recording.



Power Switch/ -10 dB Pad Button

Short press the  Power Switch/-10dB Pad Button, the Indicator Lamp 3 above is green, it is

in -10dB mode. The -10dB pad function makes sure your audio is clear and distortion-free when recording loud sound sources.

Status Indication Description

Charging in power off status: When charging the microphone with USB cable connected to TYPE-C port in power off status, the Indicator Lamp 3 above the  Power Switch/-10dB Pad Button flashes yellow every other second, and constant on yellow after fully charged.

Charging in power on status: When charging the microphone with USB cable connected to TYPE-C port in power on status, the Indicator Lamp 3 above the  Power Switch/-10dB Pad Button flashes red every other second. Short press the  Power Switch/-10dB Pad Button, and -10db mode is on, the Indicator Lamp 3 above flashes red and green every 0.5 seconds. The Indicator Lamp 3 above is constant on red or green when in power on status or -10dB mode respectively after fully charged.

Low Battery: When the battery level is lower than 10% in -10dB mode, the Indicator Lamp 3 above the  Power Switch/-10dB Pad Button flashes blue and green every 0.5 seconds. When the battery level is lower than 10% but not in -10dB mode, the Indicator Lamp 3 above the  Power Switch/-10dB Pad Button flashes blue every other second.

Frequency Response

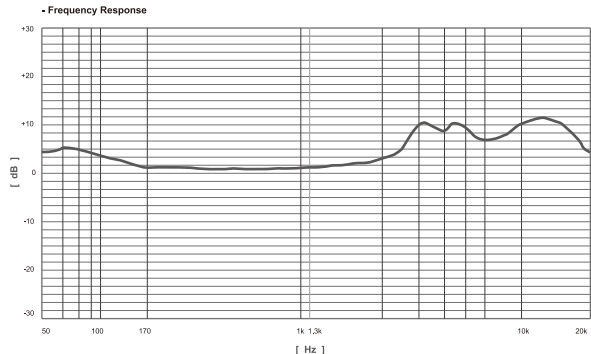

Polar Pattern

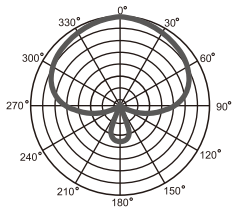

What's in the Box

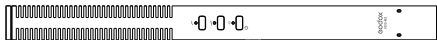

Microphonex1



Direction Adjusting
Bracketx1



Type-C USB Cablex1



Windshieldx1



Instruction Manualx1

Technique Data

Model	VDS-M3
Pickup Mode	Supercardioid
Charging Current	1.2A
Frequency Range	20Hz-20KHz
Output Impedance	200Ω
Signal-Noise Ratio	75dB
Sensitivity	-37dB±3dB
High Pass Filter Frequency	75Hz
Battery Capacity	2000mAh
Working Ambient Temperature	-10 °C~50 °C
Microphone Dimension	278mm*22mm
Microphone Net	183g

Maintenance

Avoid sudden drops. The device may fail to work after strong shocks, impacts, or excess stress.

Keep dry. The product isn't water-proof. Malfunction, rust, and corrosion may occur and go beyond repair if soaked in water or exposed to high humidity.

Avoid sudden temperature changes. Condensation happens if sudden temperature changes such as the circumstance when taking the product out of a building with higher temperature to outside in winter. Please put the product in a handbag or plastic bag beforehand.

Keep away from strong magnetic field. The strong static or magnetic field produced by devices such as radio transmitters leads to malfunction.

Declaration of Conformity:

GODOX Photo Equipment Co.,Ltd. hereby declares that the This equipment are in compliance with the essential requirements and other relevant provisions of EU Directive 2014/30/EU.

They are allowed to be used in all EU member states.

For more information of DoC, Please click this web link:

https://www.godox.com/DOC/Godox_VDS-M3_DOC.pdf

FCC Caution

This device complies with part 15 of the FCC Rules. Operation is subject to the following two conditions:

- (1) This device may not cause harmful interference, and
- (2) this device must accept any interference received, including interference that may cause undesired operation.

Any Changes or modifications not expressly approved by the party responsible for compliance could void the user's authority to operate the equipment.

Note: This equipment has been tested and found to comply with the limits for a Class B digital device, pursuant to part 15 of the FCC Rules. These limits are designed to provide reasonable protection against harmful interference in a residential installation. This equipment generates uses and can radiate radio frequency energy and, if not installed and used in accordance with the instructions, may cause harmful interference to radio communications. However, there is no guarantee that interference will not occur in a particular installation. If this equipment does cause harmful interference to radio or television reception, which can be determined by turning the equipment off and on, the user is encouraged to try to correct the interference by one or more of the following measures:

- Reorient or relocate the receiving antenna.
- Increase the separation between the equipment and receiver.
- Connect the equipment into an outlet on a circuit different from that to which the receiver is connected.
- Consult the dealer or an experienced radio/TV technician for help.

产品保修

尊敬的用户,本保修卡是申请保修服务的重要凭证,请您配合销售商填写并妥善保管,谢谢!

产品信息	型号	产品条码
用户信息	姓名	联系电话
	通信地址	
销售商信息	名称	
	联系电话	
	通信地址	
	销售日期	
备注		

注:此表应由销售商盖章确认。

产品信息

本文件适用于相关《产品保修信息》(见后面说明)所列产品其他非属此范围的产品或部件(如促销品、赠品及其他出厂后附加的部件等)不在此保修承诺内。

保修期

产品及部件的相应保修期按相关的《产品保修信息》执行。保修期自产品首次购买日起算,购买日以购买产品时保修卡登记日期为准。

如何获得保修服务

要保修服务,您可直接与产品销售商或授权服务机构联系,也可拨打神牛产品售后服务电话与我们联系,由我们的服务人员为您安排服务。申请保修时,您应提供有效的保修卡作为保修凭证,方可获得保修。如您不能提供有效的保修卡,则在我们可确认产品或部件属于保修范围的情况下,也可以为您提供保修,但这不作为我们的义务。

不适用保修的情况

如产品存在下列情况,本文件项下的保证和服务将不适用:① 产品或部件超过相应保修期;② 错误或不当使用、维护或保管导致的故障或损坏,如:不当搬运;非按产品合理预期用途使用;不当插拔外接设备;跌落或外力挤压;接触或暴露于不当温度、溶剂、酸碱、水浸或潮湿环境;③ 由非神牛授权机构或人员安装、修理、更改、添加或拆卸造成的故障或损坏;④ 产品或部件原有识别信息被修改变更或删除;⑤ 无有效保修卡;⑥ 使用非合法授权、非标准或非公开发行的软件造成的故障或损坏;⑦ 因不可抗力或意外事件造成的故障或损坏;⑧ 其他非因产品本身质量问题导致的故障或损坏。遇上述情况,您应向相关责任方寻求解决,神牛对此不承担任何责任,因非在保修期或保修范围内的部件、附件或软件导致产品不能正常使用的,不是保修范围内的故障。产品使用过程中正常的脱色、磨损和消耗,不是保修范围内的故障。

产品保修和服务支持信息

产品的保修期和服务类型按以下《产品保修信息》执行:

产品类别	选件名称	保修期(月)	保修服务类型
部件	电路板	12	客户送修
	电池	3	客户送修
	充电器、电源线、同步线等带电性能的部件	12	客户送修
其他	如电池盒、防风棉、防风毛罩、锁紧装置、手提绳、扎带、魔术贴、领夹、便携袋、包装等	无	无保修

神牛产品售后服务电话 0755-29609320-8062

Warranty

Dear customers, as this warranty card is an important certificate to apply for our maintenance service, please fill in the following form in coordination with the seller and safe-keep it. Thank you!

Product Information	Model	Product Code Number
Customer Information	Name	Contact Number
	Address	
Seller Information	Name	
	Contact Number	
	Address	
	Date of Sale	
Note		

Note: This form shall be sealed by the seller.

Applicable Products

The document applies to the products listed on the Product Maintenance Information (see below for further information). Other products or accessories (e.g. promotional items, giveaways and additional accessories attached, etc.) are not included in this warranty scope.

Warranty Period

The warranty period of products and accessories is implemented according to the relevant Product Maintenance Information. The warranty period is calculated from the day (purchase date) when the product is bought for the first time, and the purchase date is considered as the date registered on the warranty card when buying the product.

How to Get the Maintenance Service

If maintenance service is needed, you can directly contact the product distributor or authorized service institutions. You can also contact the Godox after-sale service call and we will offer you service. When applying for maintenance service, you should provide valid warranty card. If you cannot provide valid warranty card, we may offer you maintenance service once confirmed that the product or accessory is involved in the maintenance scope, but that shall not be considered as our obligation.

Inapplicable Cases

The guarantee and service offered by this document are not applicable in the following cases: ①. The product or accessory has expired its warranty period; ②. Breakage or damage caused by inappropriate usage, maintenance or preservation, such as improper packing, improper usage, improper plugging in/out external equipment, falling off or squeezing by external force, contacting or exposing to the improper temperature, solvent, acid, base, flooding and damp environments, etc; ③. Breakage or damage caused by non-authorized institution or staff in the process of installation, maintenance, alternation, addition and detachment; ④. The original identifying information of product or accessory is modified, alternated, or removed; ⑤. No valid warranty card; ⑥. Breakage or damage caused by using illegally authorized, nonstandard or non-public released software; ⑦. Breakage or damage caused by force majeure or accident; ⑧. Breakage or damage that could not be attributed to the product itself. Once met these situations above, you should seek solutions from the related responsible parties and Godox assumes no responsibility. The damage caused by parts, accessories and software that beyond the warranty period or scope is not included in our maintenance scope. The normal discoloration, abrasion and consumption are not the breakage within the maintenance scope.

Maintenance and Service Support Information

The warranty period and service types of products are implemented according to the following Product Maintenance Information:

Product Type	Name	Maintenance Period(month)	Warranty Service Type
Parts	Product Main Body	12	Customer sends the product to designated site
	Battery	3	Customer sends the product to designated site
	Charger, Power Cable, Sync Cable, Electrical Parts etc.	12	Customer sends the product to designated site
Other Items	Battery Case, Windscreen Foam, Wind Cap, Locking Device, Lanyard, Tie, Velcro Tape, Clip, Bag, Package etc.	No	Without warranty