

Godox 神牛

AD600B

WITSTRO⁺ 威客

TTL一体式外拍闪光灯
TTL ALL-in-One Outdoor Flash



深圳市神牛摄影器材有限公司

GODOX Photo Equipment Co., Ltd.

地址/Add: 深圳市宝安区福海街道塘尾社区耀川工业区厂房2栋1层至4层、4栋1层至4层
1st to 4th Floor, Building 2/ 1st to 4th Floor, Building 4, Yaochuan Industrial Zone,
Tangwei Community, Fuhai Street, Bao'an District, Shenzhen 518103, China

电话/Tel: +86-755-29609320(8062)

传真/Fax: +86-755-25723423

邮箱/E-mail: godox@godox.com

http://www.godox.com

705-AD60B0-00

Made In China



中英文双语 / Chinese English Bilingual

说明手册 / INSTRUCTION MANUAL

前言

请先仔细阅读本手册,以确保您能安全使用。

请保存好本手册以备将来查询参考。

感谢您购买神牛产品。

AD600B TTL一体式外拍闪光灯是一款无线TTL大功率闪光灯,锂电池与机身一体式,携带方便;采用内置神牛2.4G无线X系统,配合X1系列触发器可远程控制TTL/M/Multi模式触发AD600B闪光;同时,它还可以跟神牛TTL机顶灯、TTL外拍灯、TTL影室灯利用TTL主从属功能组合使用。使用AD600B闪光灯,您将获得更简单的拍摄体验,在光线变化复杂的情况下,可以自动获得准确的闪光曝光,拍摄轻松自如。

AD600B威客闪光灯,功率强劲,电池容量大,支持全程高速,单支可压太阳光,外露灯管和标罩反光罩为户外拍摄和实景拍摄提供了良好的光质。AD600B是离机闪光中的绝对主力,便携与高效光质兼具,实为自由商业摄影师、新闻记者、发烧友、摄影爱好者、婚纱纪实摄影师等的理想光源。

产品有以下亮点:

无线TTL系统全面兼容:采用内置神牛2.4G无线X系统,可支持佳能E-TTL II、尼康i-TTL等TTL自动闪光系统;可作为无线多灯闪光系统的从属单元,拍摄简单快捷

点阵液晶屏:显示直观,操作更加简易

内置2.4G无线传输:80米超远距离,创意无限

影棚光质:功率高达600Ws,闪光指数GN87(m ISO 100,使用标准反光罩)

小巧便携:灯管插拔式,携带无忧。

专业电源:大容量电源盒(11.1V/8700mAh),0.01-2.5s回电,全光500次闪光

无线操控:内置使用神牛2.4G无线X系统,可实现TTL控制,外置可使用神牛FT-16遥控器,可无线控制闪光灯功率大小等,并同步触发引闪;同时留有3.5mm同步插孔和PC端口,可实现多种同步触发方式

附件齐全:卡口采用保荣卡口,适用范围广,附件齐全,丰富实用。

调光精准:功率调节范围大(1/1-1/256),25档精确微调,光效把握更随心

色温恒定:色温全程保持在5600±200K范围内

高级功能:支持1/8000秒高速同步,高速频闪,手动辅助对焦,高速遥控器同步触发等

警告

- ▲ 请保持干燥。
- ▲ 请勿私自拆卸产品,如产品出现故障须由本公司或授权的维修人员进行检查维修。
- ▲ 禁止拆卸、撞击、挤压或投入火中,若出现严重鼓胀,请勿继续使用。
- ▲ 请勿放置在超过50度的高温环境中。
- ▲ 请勿将闪光灯头正对人眼闪光(特别是婴儿的眼睛),否则可能会在短时间内造成视力障碍。
- ▲ 请勿在化学品、可燃性气体或其他特殊物质附近使用闪光灯,这些物质在特殊情况下可能对闪光灯发出的瞬间强光敏感,有可能导致火灾或电磁干扰。在这些场合下,请注意相关警告标识。
- ▲ 本产品不能防水,在雨天及潮湿环境下请注意防水。

目录

01	前言
02	警告
05	部件名称
	机身
	液晶显示屏
	所配附件
	可选购附件
	如何装卸反光罩(或附件)
	如何装卸闪光灯管
	如何调节手柄角度
09	电池
10	电源管理
	无线模式选择
11	闪光模式--TTL自动闪光模式
	 闪光曝光补偿
	 高速同步
	闪光模式--M: 手动闪光
	闪光模式--Multi: 频闪闪光
15	无线闪光拍摄：无线电(2.4G)传输
	无线设置
	设置通讯频道
	设置通讯组别
	无线闪光拍摄
18	无线闪光拍摄：光学传输
	无线设置
	设置通讯频道
	设置通讯组别
20	C.Fn：设置自定义功能
21	造型灯
21	其他应用
	外置无线控制功能
	同步插孔触发
22	保护功能
23	规格参数
24	故障排除指南
24	固件升级
24	维护保养

本说明书中使用的约定

- 此使用说明书中的操作步骤假定相机和闪光灯的电源开关已开启。
- 参考页码由(第**页)表示。
- 此使用说明书中使用以下警告符号：

 该“小心”符号表示避免出现拍摄问题的警告。

 该“注意”符号提供补充信息。

部件名称

机身：

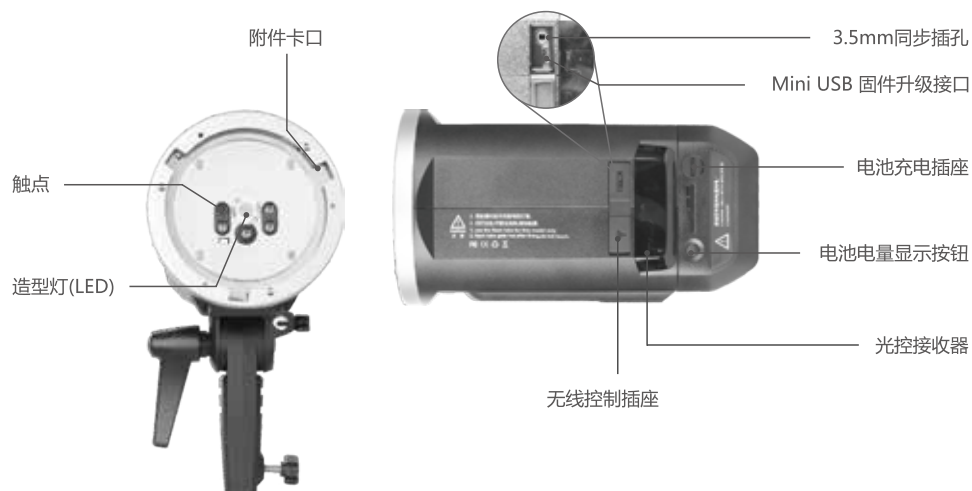
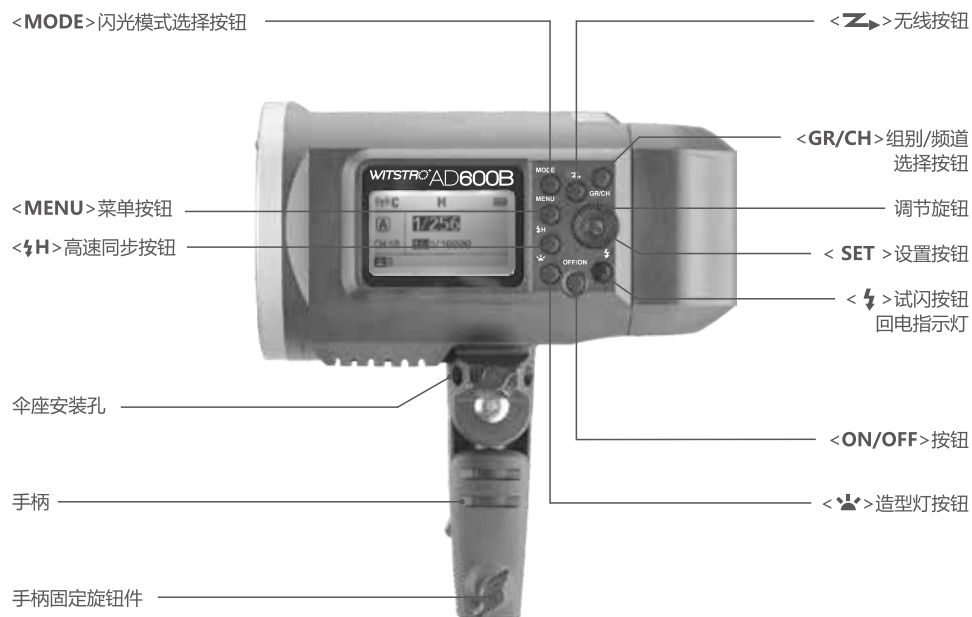

部件名称

机身：

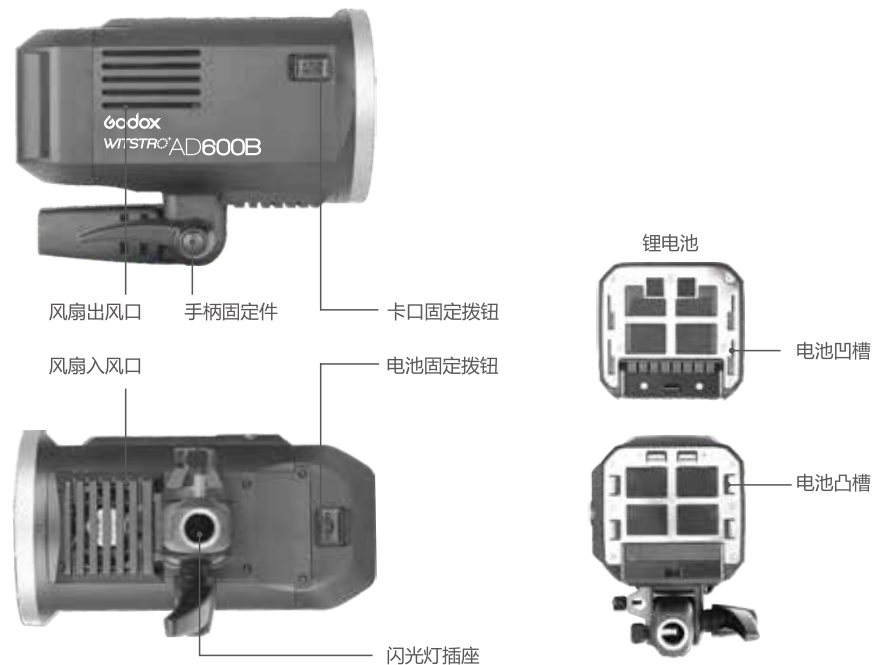

LCD液晶显示屏

(1) TTL自动闪光

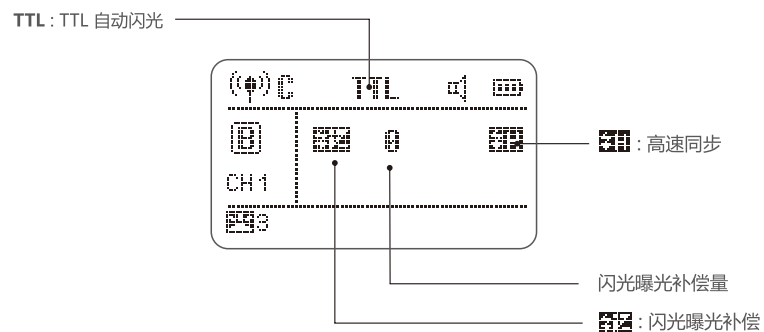

部件名称

LCD液晶显示屏

(2)M手动闪光

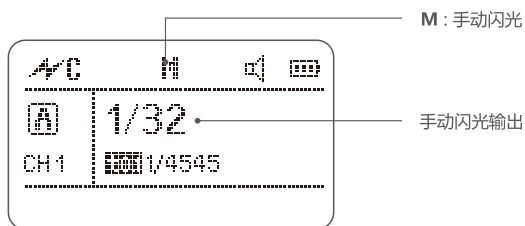

(3)Multi频闪光

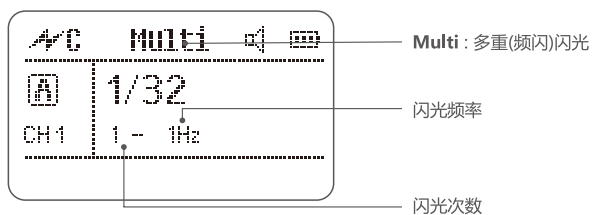

(4)无线电传输拍摄/光学传输无线拍摄

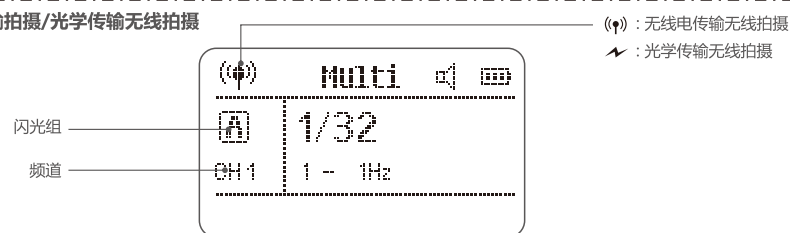

(5)从属单元

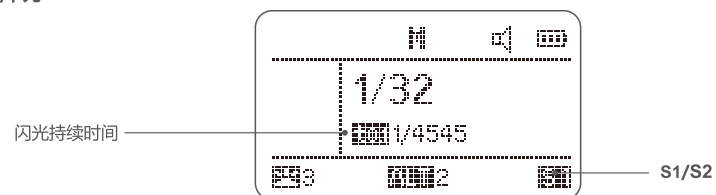

所配附件

- 1、灯管 2、锂电池 3、充电器 4、电源线 5、灯头保护罩 6、说明书



部件名称

可选购附件

AD600B采用保荣卡口,适用附件丰富,也可搭配本公司以下摄影附件使用,以获得最佳的拍摄效果和使用体验:
X1引闪器、FT-16遥控器、柔光箱、雷达罩、折叠柔光伞、束光筒、灯架等。



如何装卸反光罩(或附件)



- 1、拨动卡口固定拨钮。
- 2、将反光罩插入附件卡口并沿顺时针方向旋转锁紧。
- 3、安装完成。

如何装卸闪光灯管



- 1、拨动卡口固定拨钮。卸下反光罩或者其他附件。
- 2、将闪光灯管对准闪光灯插座,插入闪光灯。

如何调节手柄角度



- 1、手柄固定件未拔出状态下,顺时针锁紧,逆时针旋松。
- 2、手柄固定件旋转角度限制在灯体下方0~180度,碰到灯体前请把手柄固定件拉出调整旋转角度之后继续动作1。

电池

特性

1. 本品采用锂电池,支持反复充放电500次,使用寿命长。
2. 安全可靠,内置电路有过充保护、过放保护、过流保护、短路保护。
3. 使用标配电池充电器只需4个小时左右。

注意事项

- ▲ 避免正负极短路。
- ▲ 电池没有防水功能,不要把电池浸泡在雾、水中。
- ▲ 放置于儿童不易接触的地方。
- ▲ 电池充电不要放置超过24小时。
- ▲ 电池应放置于凉爽、干燥及通风的地方存储。
- ▲ 电池不要靠近和放置于火中。
- ▲ 电池使用报废后请按当地的规定处理。
- ▲ 如果电池超过3个月不使用,请对电池进行满电充电。

装卸电池

安装电池:

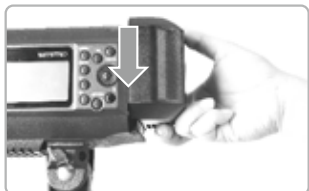

1 电池卡槽与主体电池槽对齐。

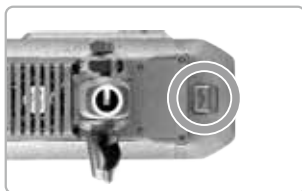

2 往下推直至扣件卡住。

拆卸电池:

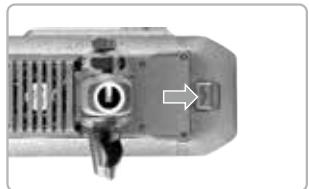

1 往右轻推扣件。



2 往上推出电池。

电池

电池电量指示

把锂电池正确安装在闪光灯上,即可给闪光灯供电。使用时请查看闪光灯屏幕上电池图标,即可随时掌握电量状态。

LCD屏电量符号显示 (针对整个闪光灯系统的 电量指示和管理)	电池上LED显示 (无负载下针对电池 电量的指示和管理)	意义
3格	1红+3绿	满电
2格	1红+2绿	中电
1格	1红+1绿	低电
无格	1红	电量少,请及时充电。
无格闪烁		电量即将用尽,此状态不支持闪光灯工作,1分钟后将自动关机。 注:此状态请尽快(10天内)充电,才可使用或放置。

注:显示大体一致,但在档位交替时会有一些差别。

电源管理

*长按2秒ON/OFF按钮控制该产品的打开和关闭,长时间不使用时请关闭电源。本产品设计有电源自动关闭功能。在长时间(约1小时)无人操作时,闪光灯会自动关闭。

 **C.Fn** 离机使用时,建议通过自定义功能使“自动关闭电源”无效。(C.Fn-SLEEP 第20页)

无线模式选择

AD600B只能作为从属单元(接收端),通过按无线按钮进行切换有2种无线模式:无线电传输和光学传输。无线电传输模式下闪光灯会根据X1系列发射器自动切换Canon(C)或者Nikon(N)系统进行闪光。光学传输模式下请先设置好Canon(C)或者Nikon(N),再进行引闪。

无线模式	闪光模式
OFF	M / Multi
无线电传输	TTL / M / Multi
光学传输	TTL / M / Multi

闪光模式——TTL自动闪光模式

该闪光灯有**TTL**自动闪光,**M**手动闪光,**Multi**频闪三种模式。在**TTL**模式下,相机的测光系统会侦查从主体反射回来的闪光照明,从而自动调节闪光输出量,使主体和背景得到均衡曝光。

* 按下 < **MODE** > 模式选择按钮,三种闪光模式将会依次出现在液晶屏上。

TTL模式

* 通过按 < **MODE** > 模式选择按钮,将闪光灯设置为 < **TTL** >, 可以使闪光灯进入**TTL**模式。

闪光曝光补偿

该闪光灯可以在±3档间以1/3档为增量调节闪光曝光补偿。由于环境的需求而需要微调TTL系统时,这个功能非常有用。

设置闪光曝光补偿：

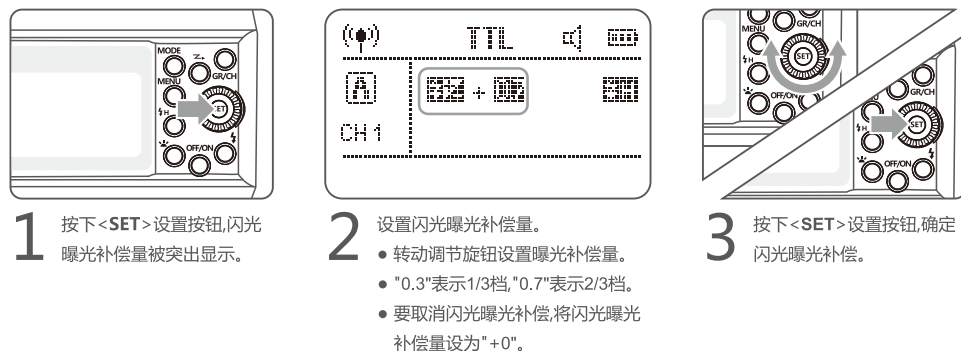

1 按下<SET>设置按钮,闪光曝光补偿量被突出显示。

2 设置闪光曝光补偿量。
 • 转动调节旋钮设置曝光补偿量。
 • "0.3"表示1/3档,"0.7"表示2/3档。
 • 要取消闪光曝光补偿,将闪光曝光补偿量设为"+0"。

3 按下<SET>设置按钮,确定闪光曝光补偿。

高速同步

使用高速同步(FP闪光),您可以在所有的快门速度下同步使用闪光灯。高速同步闪光在使用光圈优先对人像进行填充闪光时特别方便。

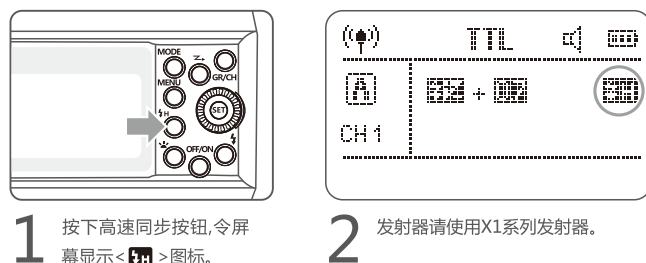

1 按下高速同步按钮,令屏幕显示 < **FP** > 图标。

2 发射器请使用X1系列发射器。

- 如果设置快门速度等于或慢于相机的最大闪光同步速度,取景器中将不显示 < **FP** > 。
- 使用高速同步,快门速度越高,有效的闪光范围就越小。
- 要恢复普通闪光,请再次按高速同步按钮。 < **FP** > 图标会消失。
- 在高速同步模式下,无法设置频闪闪光。
- 连续高速同步闪光50次后,闪光灯热保护功能可能会被激活。

闪光模式——M: 手动闪光

您可以在1/256功率至1/1全功率间以1/3档为增量设置闪光输出。为获得正确的闪光曝光,请使用手持的闪光测光表确定所需的闪光输出。



1 按<MODE>模式选择按钮,屏幕显示<M>。

2 转动调节旋钮设置闪光输出功率。

3 按下<SET>设置按钮,确定闪光曝光补偿。

显示闪光输出

拍摄过程中更改闪光输出时,下表将清楚地显示光圈值是如何更改的,如1/2-0.3→1/2+0.3。您可以在增加或减少闪光输出时查看光圈值的更改规律。

例如,将闪光输出量减少至1/2、1/2-0.3或1/2-0.7,然后再将其增加至大于1/2、1/2+0.3、1/2+0.7时,将显示1/1。

	减少闪光输出指数 →						
1/1	1/1-0.3	1/1-0.7	1/2	1/2-0.3	1/2-0.7	1/4
	1/2+0.7	1/2+0.3		1/4+0.7	1/4+0.3	
	← 增加闪光输出指数						

S1光控单元设置

在**M**手动闪光模式下,按<MENU>按钮进入**C.FN - SLAVE**选择**S1**功能,闪光灯可作为副灯使用,创造多种照明效果,适用于手动闪光环境。它会与主闪光灯的第一次闪光同步触发闪光,效果与使用无线引闪器一致。

S2光控单元设置

按<MENU>按钮进入**C.FN - SLAVE**选择**S2**功能,闪光灯可作为副灯使用,适用于TTL闪光环境。具有防预闪功能,使用带一次预闪功能的相机能用光控实现同步拍摄。它会与主闪光灯的第二次闪光同步触发闪光,即2次光控引闪。

- 只有在**M**模式下才支持**S1/S2**光控引闪模式。

闪光模式——M: 手动闪光

显示闪光持续时间

闪光持续时间是指闪光灯从开始发光到达发光半峰值的时间长度。半峰值的表示为 $t=0.5$ 。为了给摄影师提供更详细的拍摄数值,本产品采用 $t=0.1$ 。如下图: $t=0.5$ 与 $t=0.1$ 区别。

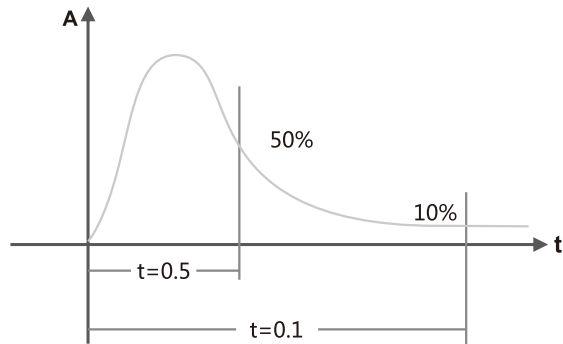

- 只有在M模式下才会显示持续时间。

在M模式无高速连拍时,将会显示持续时间:

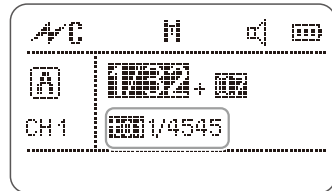

闪光模式——Multi: 频闪闪光

使用频闪闪光,可以发出一系列快速的闪光。它可以在一张照片上拍摄移动物体的多个图像。您可以设置闪光频率(每秒的闪光次数,以Hz表示)、闪光次数和闪光输出。

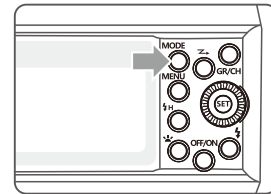

- 按<MODE>闪光模式选择按钮,屏幕显示<MULTI>。

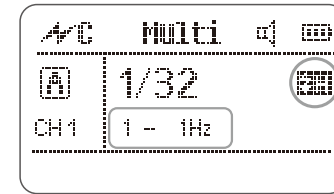

- 转动调节旋钮设置闪光输出功率。

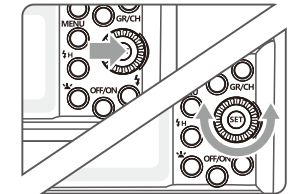

- 设置闪光频率和闪光次数。
 - 按<SET>按钮选择闪光次数,旋转调节旋钮设定数字。
 - 按<SET>按钮选择闪光频率,旋转调节旋钮设定数字。
 - 按下<SET>设置按钮确定,所有设置都将显示出来。

计算快门速度

在频闪闪光过程中,到闪光停止为止快门应保持开启状态。使用下面的公式计算快门速度,然后用相机进行设置。

$$\text{闪光次数/闪光频率} = \text{快门速度}$$

例如,如果闪光次数是10,闪光频率是5Hz,快门速度则至少为2秒。

- ⚠ 为防止闪光灯过热并损坏,请勿执行连续10次以上的频闪闪光连拍。闪光10次后,请让闪光灯至少冷却15分钟。如果您试图执行连续10次以上的频闪闪光连拍,为防止闪光灯过热,闪光可能自动停止。如果发生了这种情况,请让闪光灯至少冷却15分钟。

- 反光很强的被摄体在暗背景前使用频闪闪光更加有效。
- 推荐使用三脚架和遥控开关。
- 闪光输出为1/1和1/2时不能设置频闪闪光。
- 频闪闪光时也可以使用“bulb”。
- 如果闪光次数显示为--,则闪光灯会连续闪光,直到快门或电池耗尽。如下表所示,闪光次数将受到限制。

最大频闪闪光次数

闪光输出	Hz	1	2	3	4	5	6-7	8-9	10	11	12-14	15-19	20-50	60-100
1/4		7	6	5	4	4	3	3	2	2	2	2	2	2
1/8		14	14	12	10	8	6	5	4	4	4	4	4	4
1/16		30	30	30	20	20	20	10	8	8	8	8	8	8
1/32		60	60	60	50	50	40	30	20	20	20	18	16	12
1/64		90	90	90	80	80	70	60	50	40	40	35	30	20
1/128		100	100	100	100	100	90	80	70	70	60	50	40	40
1/256		100	100	100	100	100	90	80	70	70	60	50	40	40

无线闪光拍摄：无线电(2.4G)传输

AD600B使用神牛2.4G无线X系统,可以与本厂其他型号完美结合使用。作为从属单元可兼容佳能E-TTL II系统和尼康i-TTL系统,根据主控单元自动切换,无需手动设置。接收到主控信号显示屏会相应显示"C"或者"N"。尼康相机(使用X1T-N、TT685N等)和佳能相机(使用X1T-C、TT685C等)可同时同地共享一台或多台AD600B,无缝结合,无懈可击!

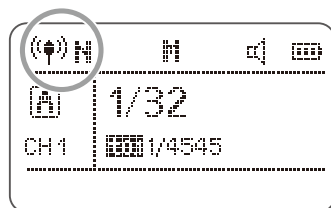
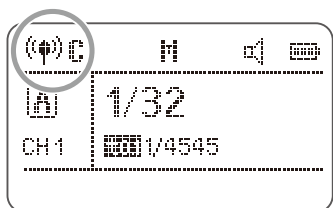

*AD600B作为从属单元,可受控主控单元型号: AD360II-C、AD360II-N、TT685C、TT685N、X1T-C、X1T-N、TT600

无线设置

再次按下 <Z> 无线设置按钮,令屏幕显示 <(C)>

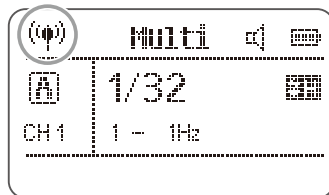
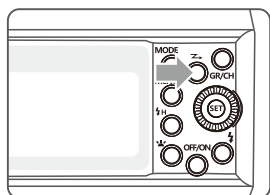

设置通讯频道

如果在拍摄现场不止一个无线闪光系统,您可以通过更改通讯频道来防止信号干扰。保证主控单元和从属单元设置为相同的频道编号即可。

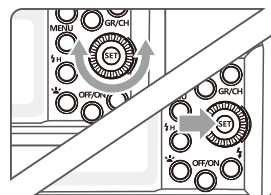
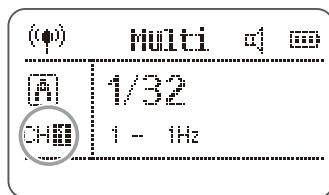
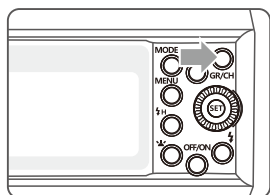

1 长按 <GR/CH> 按钮2秒, 频道编号反向显示。

2 旋转调节旋钮从1至32中选择频道。

3 按下 <SET> 设置按钮,确定 闪光曝光补偿。

无线闪光拍摄：无线电(2.4G)传输

设置通讯组别

短按 <GR/CH> 按钮,A~E组别依次改变。

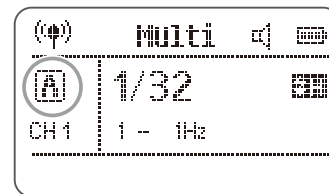
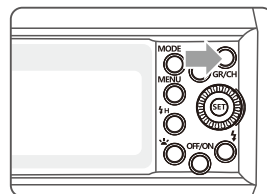

无线闪光拍摄

定位和操作范围(无线闪光拍摄的示例)

- 使用一个从属单元进行自动闪光拍摄

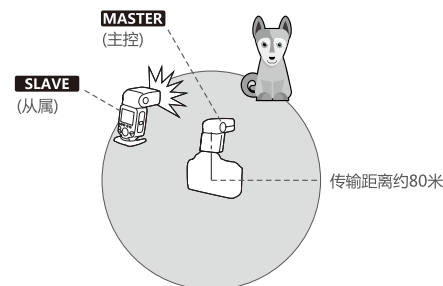

- 使用附带的微型支架定位从属单元。
- 开始拍摄前请进行测试闪光和试拍。
- 受从属单元的位置、周围环境、天气状况等影响,传输距离可能更短。

无线闪光拍摄：无线电(2.4G)传输

无线多重闪光拍摄

可以将从属单元分割为两个或三个组并在改变闪光光比(倍率)的同时进行TTL自动闪光拍摄。此外,可以为各闪光组(最多5个组)设定并用不同的闪光模式拍摄。

- 用两个从属组进行自动闪光拍摄。

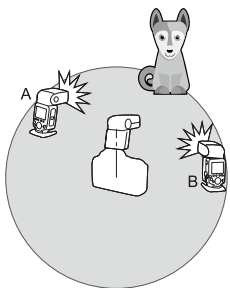

- 用三个从属组进行自动闪光拍摄。

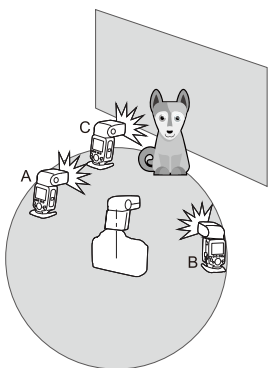

无线电传输比光学传输的拍摄具有优势,距离更远,耗电更少,受障碍物的影响更小。

无线电传输和光学传输的差异：

功能	无线电传输	光学传输
传输距离	80m(X1发射器系列)	约10m
频道	1~32	1~4
组别	A/B/C/D/E	A/B/C
受干扰程度	难	易

无线闪光拍摄：光学传输

该产品支持无线闪光功能,具有从属闪光功能,通过MENU菜单的C.FN-REMOTE选择是Canon光无线系统还是Nikon光无线系统：

- 兼容Canon光无线系统：
可接收580EXII、600EX-RT闪光灯无线信号、7D/60D/600D内闪指令,从而实现无线闪光。
- 兼容Nikon光无线系统：
可接收SB-900、SB-910闪光灯无线信号、D7100/D7000/D800内闪指令,从而实现无线闪光
- 通过此款产品,支持创建1至3个从属单元组,并实现TTL自动闪光。您可以通过TTL自动闪光轻松获取多种照明效果。

主控单元/从属单元设置位置和范围

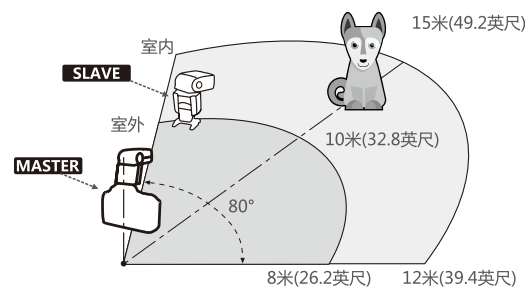

无线设置

再次按下<Z>无线设置按钮,令屏幕显示<Z>。

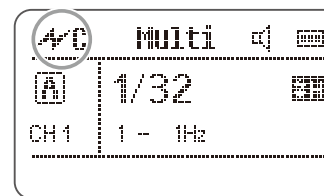
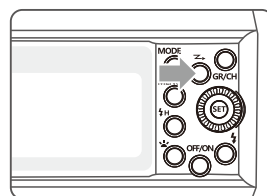

设置通讯频道

如果在拍摄现场不止一个无线闪光系统,您可以通过更改通讯频道来防止信号干扰。保证主控单元和从属单元设置为相同的频道编号即可。

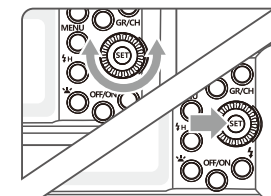
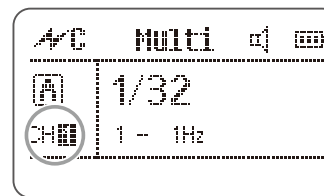
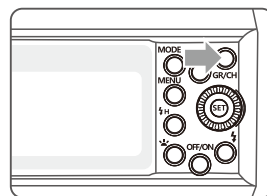

1 长按<GR/CH>按钮2秒,频道编号反向显示。

2 旋转调节旋钮从1至4中选择频道。

3 按下<SET>设置按钮,确定闪光曝光补偿。

无线闪光拍摄：光学传输

设置通讯组别

短按 <GR/CH> 按钮, A~C 组别依次改变。

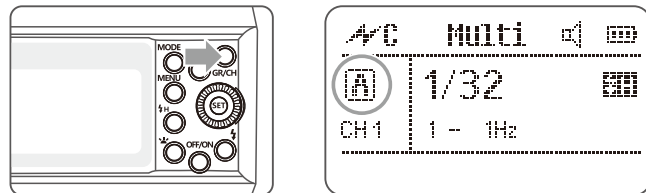

! 如果从属单元附近有荧光灯或电脑显示器, 这些光源的存在可能会导致从属单元发生故障, 并导致其意外闪光。

C.Fn: 设置自定义功能

自定义功能符号	功能	设置符号	设置和说明	使用范围限制
BEEP	蜂鸣器	ON	启动	无
		OFF	关闭	
SLAVE	S1/S2模式选择	OFF	关闭	M模式
		S1	S1模式	
		S2	S2模式	
FAN	风扇工作模式	OFF	关闭	无
		AUTO	温度 <45° : 关闭	
			温度 >45° : 低风	
	温度 >60° : 高风			
SLEEP	自动关闭电源	OFF	关闭	无
		1HR	没有任何操作自动关闭	
		2HR		
		3HR		
LIGHT	背光点亮时间	12sec	12秒后自动熄灭	无
		OFF	一直熄灭	
		ON	一直点亮	
DELAY	延时闪光	OFF, 0.01~30S	可作为后帘引闪	M/Multi模式
UNITS	闪光灯总数	2~4	UNITS与ALT必须结合使用： UNITS设置了总灯数； ALT设置了此灯 在触发几次后引闪	M模式
ALT	触发次数引闪			M模式
LCD	液晶屏对比度	0~9	10个级别	
REMOTE	光无线遥控系统	CANON	佳能	光无线模式
		NIKON	尼康	光无线模式
RESET	参数重置	NO		无
		YES	重置	

1. 按下 <MENU> 按钮进入 C.Fn 菜单。右上角 "Ver x.x" 表示软件版本号。

2. 选择自定义功能符号。

- 旋转调节旋钮设置自定义功能符号。

造型灯

3. 更改设置。

- 按<SET>设置按钮,自定义功能编号突出显示。
- 旋转调节旋钮设置想要的编号,按<SET>按钮确定。

4. 退出C.Fn菜单。

- 按<MENU>按钮退出。

造型灯

AD600B配置10W LED造型灯,3档调控,2种长亮模式。

- 短按造型灯按钮可设置档位:
 - 1档: 30%输出,30分钟自动熄灭(防止过热)。
 - 2档: 60%输出,20分钟自动熄灭(防止过热)。
 - 3档: 100%输出,10分钟自动熄灭(防止过热)。
- 长按造型灯按钮2秒可设置造型模式:
 1. 长亮
 2. 引闪时造型灯熄灭

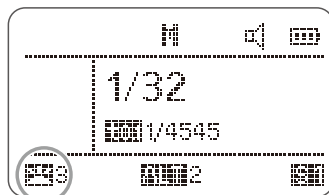
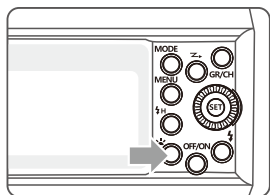

其他应用

外置无线控制功能

闪光灯内置无线控制插座,配合特定遥控器使用,您可以实现对闪光灯的无线控制。将FT系列遥控器的接收端插入无线控制插座,手持遥控器发射端,即可远程控制闪光灯的功率开关和大小、闪光灯触发等。您也可以将发射端置于相机热靴上,通过相机快门来进行同步引闪。

- 更多遥控器的使用方法,请查阅FT系列遥控器的说明书。

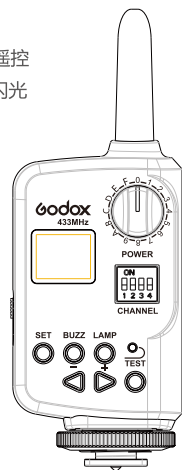
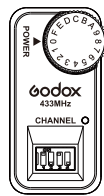

同步插孔触发

同步插孔规格为Φ3.5mm,此处可插入同步线或者触发器触发插头对闪光灯进行同步引闪。

保护功能

1. 热保护

- 为防止闪光灯过热并损坏,请勿在1/1功率时进行超过100次的快速连续闪光。100次连续闪光后,要让闪光灯至少冷却10分钟。
- 如您在进行超过100次连续闪光后马上继续进行更多次闪光,内部的防过热功能可能会被激活,使充电时间变为10秒以上。如果发生这种现象,请让闪光灯冷却约10分钟,闪光灯便会恢复正常。
- 热保护启动后,显示屏上 的符号会显示。

激活热保护功能的连续闪光次数:

功率	次数
1/1	100
1/2(+0.3,+0.7)	150
1/4(+0.3,+0.7)	200
1/8(+0.3,+0.7)	300
1/16(+0.3,+0.7)	400
1/32(+0.3,+0.7)	500
1/64(+0.3,+0.7)	1000
1/128(+0.3,+0.7)	
1/256(+0.3,+0.7)	

高速同步模式下,激活热保护功能的连续闪光次数:

功率	次数
1/1	50
1/2(+0.3,+0.7)	60
1/4(+0.3,+0.7)	75
1/8(+0.3,+0.7)	100
1/16(+0.3,+0.7)	150
1/32(+0.3,+0.7)	200
1/64(+0.3,+0.7)	300
1/128(+0.3,+0.7)	
1/256(+0.3,+0.7)	

2. 其他保护

- 为了保证设备安全的工作,系统时刻进行预防保护,以下提示符号供您参考:

LCD显示	警示内容
E1	闪光灯回电系统出现问题,无法回电引闪,请重新开机,如无法解决请维修
E2	设备内温度过高,请停止引闪10分钟
E3	闪光灯管两端电压过高,请维修
E9	固件升级有误,请进行正确固件升级

规格参数

型号	AD600B	
无线从属单元模式	无线电模式(兼容NIKON & CANON)	
	光无线(兼容NIKON & CANON)	
闪光模式	无线关闭	M/Multi
	无线电从属模式	TTL/M/Multi
	光无线从属模式	TTL/M/Multi
无线电从属单元兼容相机	NIKON相机 I-TTL/M/RPT 闪光(主控单元X1N等) CANON EOS相机E-TTL II/M/MULTI闪光(主控单元X1C等)	
闪光指数(1/1档位)	87(m ISO 100,使用标准反光罩)	
闪光持续时间	1/220秒 - 1/10000秒 (T0.1)	
POWER	600W	
档位	9级:1/256~1/1	
频闪闪光	具备 (次数:100次 ; 频率:100Hz)	
闪光曝光补偿(FEC)	手动,闪光包围曝光:在±3档间以1/3档为增量调节	
同步方式	高速同步(最高1/8000秒),前帘同步,后帘同步	
延时引闪	0.01~30秒	
蒙板	√	
风扇	√	
蜂鸣器	√	
Model造型灯(LED)	10W	
光控引闪	S1/S2	
显示闪光持续时间	√	
显示	点阵屏	
无线闪光(光学传输和无线电2.4G传输)		
无线功能	从属单元,关闭	
可控制从属单元组	光学	3组:A,B,C
	2.4G	5组:A,B,C,D,E
传输范围(约)	光学	室内:12~15米/39.4~49.2英尺 室外:8~10米/26.2~32.8英尺
	2.4G	80米
频道	光学	4组:1,2,3,4
	2.4G	32组:1~32
电源		
电源	锂电池(11.1V/8700mAh)	
全功率闪光次数	500次	
回电时间	约0.01-2.5秒	
电池电量指示	√	
节能	闪光灯在无人操作1小时将会自动关闭电源。	
同步触发方式	3.5mm同步线,无线控制插座	
色温	5600±200K	
尺寸		
体积(含电池)	220x245x125mm (不含灯管和反光罩)	
净重(含电池)	2.69 Kg (不含灯管和反光罩)	

故障排除指南

如果遇到问题,请参阅此故障排除指南。

闪光曝光不足或过度。

- 照片中存在反光强烈的物体(玻璃窗户等)。→使用闪光曝光锁定(**FEL**)。
- 使用高速同步。→使用高速同步,有效的闪光范围会更小。确保被摄体位于显示的有效闪光范围内。
- 闪光灯使用手动曝光模式。→改为**TTL**模式或修改闪光输出功率设置。

固件升级

本机通过USB插座可进行固件升级。软件最新公告及说明将会发布在官方网站上。

 注: 本品出厂不配USB升级线,请另行购买。普通的USB线可使用,本产品USB口为Micro USB 接口。

维护保养

- 闪光灯在工作时,如发现异常,应立即关掉电源,查明原因。
- 灯体应避免震动,平时注意表面除尘。
- 灯体稍有发热为正常现象,无特别需要时,勿连续引闪。
- 闪光灯的所有维修概由本厂指定可供原厂配件之维修部负责。
- 1年保修,消耗品如灯管等,不在1年保修范围。
- 经发现,擅自检修此闪光灯的,将取消闪光灯之一年保修期,维修需要收取相关费用。
- 如果本品出现故障或者被水淋湿,在专业人员维修后方可继续使用。
- 如有技术更改,恕不另行通知。

Foreword

Before using this product

Please read this user manual carefully in order to ensure your safety and the proper operation of this product. Keep for future reference.

Thank you for purchasing a GODOX product.

WITSTRO TTL All-in-One Outdoor Flash AD600B has strong power, all-in-one lithium battery pack and great portability. When using Godox 2.4G wireless X system off camera, AD600B can be triggered by X1 series flash trigger in TTL/M/Multi mode, etc. With master & slave functions, AD600B can also use in combination with Godox TTL camera flashes, TTL outdoor flashes, TTL studio flashes, etc. With this AD600B flash, your shooting will become simpler. You can easily achieve a correct flash exposure even in complex light-changing environments. WITSTRO AD600B flash system is an AD600B flash with a bare tube, wireless flash trigger, and a range of dedicated light shaping accessories. AD600B offers studio quality light for outdoor and live shooting. The AD600B offers:



- **Compatible wireless TTL system:** Fully support Canon E-TTL II, Nikon i-TTL and other TTL systems in Godox 2.4G wireless X system. Workable as Slave unit in a wireless flash group.
- **Dot-matrix LCD panel:** with clear and convenient operation.
- **Built-in 2.4G wireless transmission:** with all-in-one functions and 80 meters further transmission
- **Studio quality light:** up to 600Ws, GN 87 (m ISO 100, with standard reflector).
- **External battery pack:** professional lithium battery pack (lithium, 11.1V/8700mAh), 0.01-2.5s recycling and 500 full power flashes.
- **Lightweight and portable** even with power and accessories
- **Wireless control:** With built-in Godox 2.4G wireless X system to achieve TTL control. Godox FT-16 flash trigger can also be used to wirelessly adjust flash power level and trigger the flash. AD600B has 3.5mm sync cord jack and PC sync socket to achieve various sync triggering mode.
- **Wide-range accessories:** AD600B adopts Bowens mount whose accessories includes softbox, beauty dish, snoots, color gels, etc.
- Power adjusts from full power to 1/256 in 1/3 stop increments
- Stable color temperature at 5600±200K over the entire power range
- 1/8000s high-speed sync flash, Focus-assist beam on/off & high-speed sync triggering

The powerful and portable AD600B meets the demands of freelance commercial photographers, photojournalists, wedding and beach portraiture shooters, event and backpack photographers, photograph enthusiasts, etc.



Warning

- ▲ Always keep this product dry. Do not use in rain or in damp conditions.
- ▲ Do not disassemble. Should repairs become necessary, this product must be sent to an authorized maintenance center.
- ▲ Stop using this product if it breaks open due to extrusion, falling or strong hit. Otherwise, electric shock may occur if you touch the electronic parts inside it.
- ▲ Do not fire the flash directly into the eyes (especially those of babies) within short distances. Otherwise visual impairment may occur.
- ▲ Do not use the flash unit in the presence of flammable gases, chemicals and other similar materials. In certain circumstances, these materials may be sensitive to the strong light emitting from this flash unit and fire or electromagnetic interference may result.
- ▲ Do not leave or store the flash unit if the ambient temperature reads over 50°C (e.g. in automobile). Otherwise the electronic parts may be damaged.

Contents

25	Foreword
26	Warning
29	Name of Parts
	Body
	LCD Panel
	Included Accessories
	Separately Sold Accessories
	Installing Reflector (Other Accessories)
	Attaching Flash Tube
	Adjusting Handle
33	Battery
34	Power Management
	Wireless Flash Mode
35	Flash Mode— TTL Autoflash
	 FEC (Flash Exposure Compensation)
	 High-Speed Sync
36	Flash Mode—M: Manual Flash
38	Flash Mode—Multi/Stroboscopic Flash
39	Wireless Flash Shooting: Radio (2.4G) Transmission
	Wireless Settings
	Setting the Communication Channel
	Setting the Communication Group
	Wireless Flash Shooting
42	Wireless Flash Shooting: Optical Transmission
	Wireless Settings
	Setting the Communication Channel
	Setting the Communication Group
44	C.Fn: Setting Custom Functions
45	Modeling Lamp
45	Other Applications
	Wireless Control Function
	Sync Triggering
46	Protection Function
47	Technical Data
48	Troubleshooting
48	Firmware Upgrade
48	Maintenance

Conventions used in this Manual

- This manual is based on the assumption that both the camera and camera flash's power switches are powered on.
- Reference page numbers are indicated by "p.**".
- The following alert symbols are used in this manual:
 -  The Caution symbol indicates a warning to prevent shooting problem.
 -  The Note symbol gives supplemental information.

Name of Parts

Body:

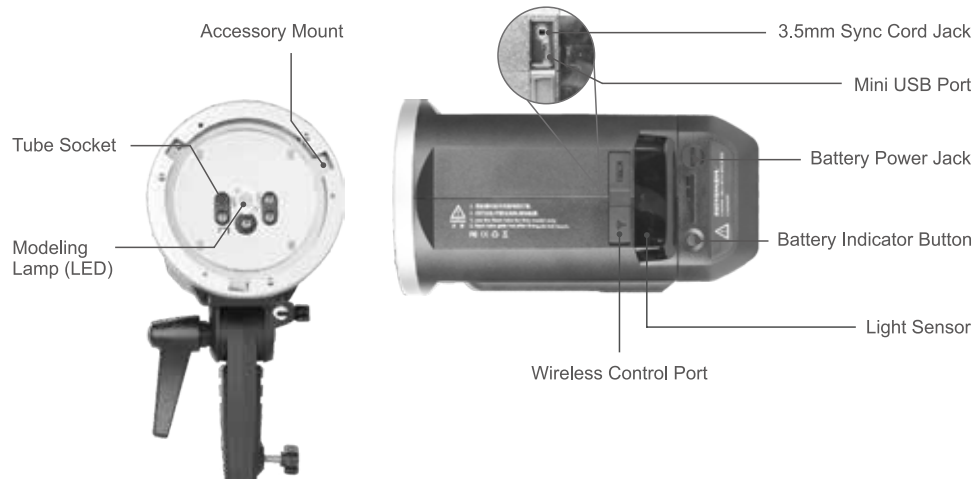
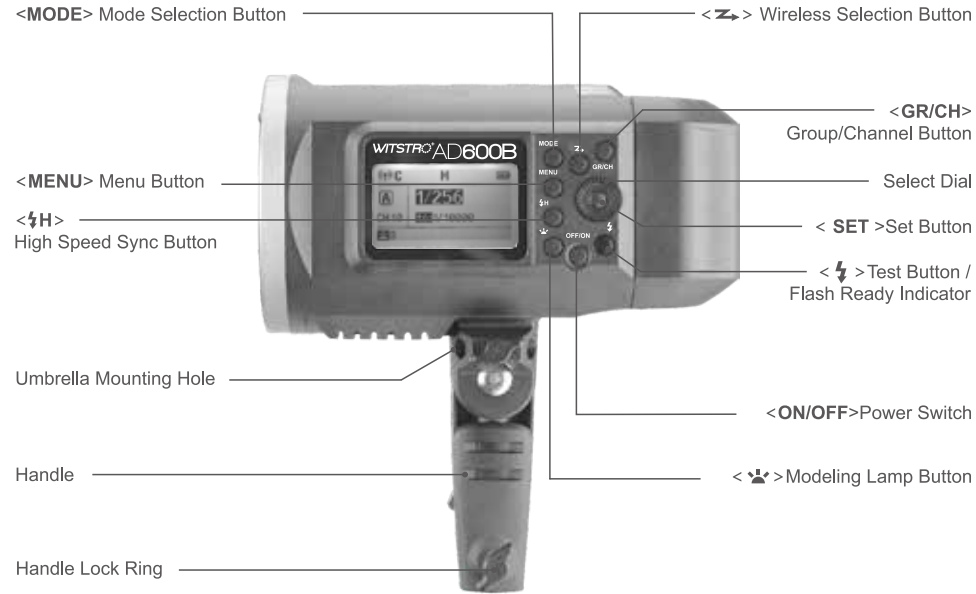

Name of Parts

Body:



LCD Panel:

(1) TTL Autoflash

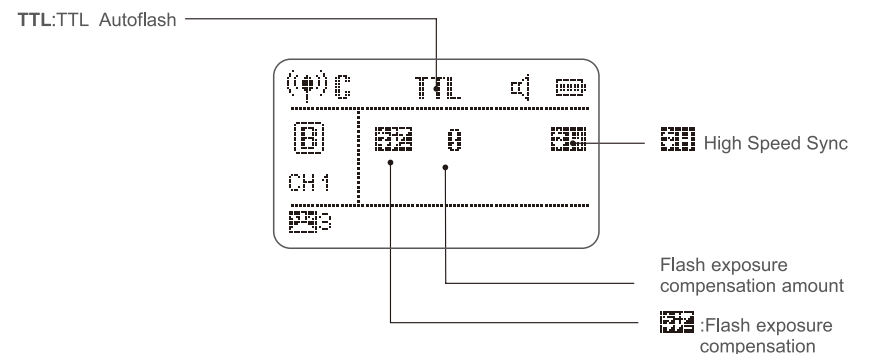

Name of Parts

LCD Panel:

(2) M Manual Flash

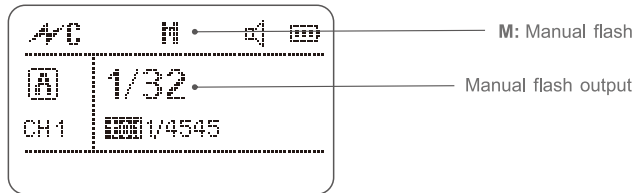

(3) Multi Flash

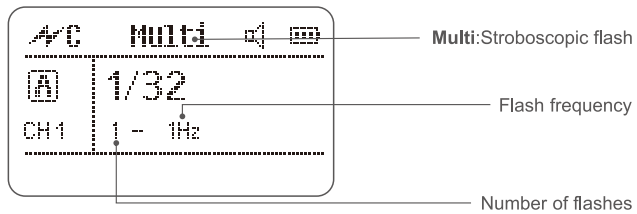

(4) Radio Transmission Shooting/Optical Transmission Shooting

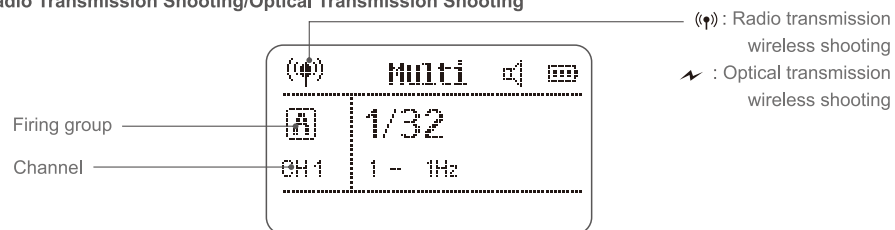

(5) Slave Unit

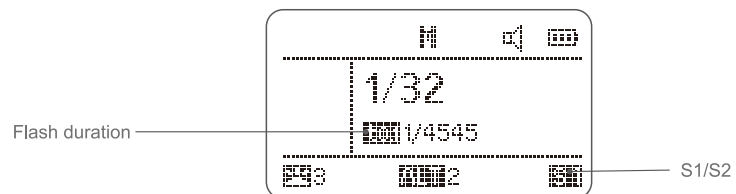

Included Accessories

1. Flash tube 2. Lithium battery pack 3. Battery charger 4. Power cord 5. Lamp cover 6. Instruction manual



Name of Parts

Separately Sold Accessories

AD600B can be used in combination with the following accessories sold separately, so as to achieve best photography effects: X1 Wireless Flash Trigger, FT-16 Remote Control, Softbox, Beauty Dish, Fold Up Umbrella, Snoots, Light Stand, etc.



Installing Reflector (Other Accessories)



1. Press down the Accessory Locking Ring.

2. Insert the reflector into the Accessory Mount and clock wise to lock it up.

Attaching Flash Tube



1. Remove the reflector or other accessories from the flash head.

2. Match the flash tube in the Tube Socket. Push the flash tube in until it is securely seated into the socket.

Adjusting Handle

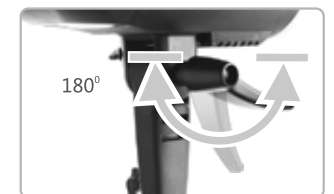
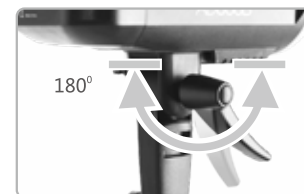

1. When the Direction Adjusting Handle is not pulled out, screw clockwise while unscrew anti clockwise.

2. The Direction Adjusting Handle's rotation angle should be restrained from 0 to 180 degrees below the flash body. Please pull out the Direction Adjusting Handle, adjust the appropriate angle, and manipulate the step 1 before colliding with the flash body.

Battery

Features

1. This flash unit uses Li-ion polymer battery which has long runtime. The available charge-and-discharge times are 500.
2. It is reliably safe. The inner circuit is against overcharge, overdischarge, overcurrent, and short circuit.
3. Take only 4 hours to fully charge the battery by using the standard battery charger.

Cautions

- ▲ Do not short circuit.
- ▲ Do not expose to rain or immerse into water. This battery is not water proof.
- ▲ Keep out of reach of children.
- ▲ No over 24 hours' continuous charging.
- ▲ Store in dry, cool, ventilated places.
- ▲ Do not put aside or into fire.
- ▲ Dead batteries should be disposed according to local regulations.
- ▲ If the battery had ceased using for over 3 months, please make a full recharge.

Loading and Unloading the Battery Pack

Loading:



- 1 Match the battery's groove with the main battery compartment's ridge.

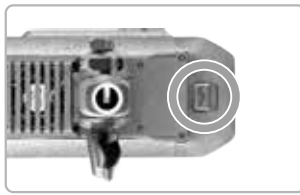

- 2 Push down the battery pack until it is locked.

Unloading:

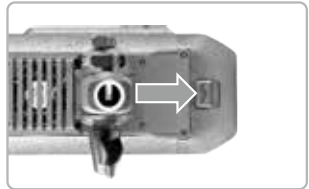

- 1 Push the Battery Locking Ring to the right.



- 2 Push the battery pack upward to unload it.

Battery

Battery Level Indication

Attach the battery pack to the flash correctly. Be aware of the battery level by check the battery level indication on the LCD panel when using.

Battery Level Indication on the LCD Panel (Indicating battery level and management of the whole flash system)	LED Battery Level Indication on the Battery (Indicating battery level and management of non-loaded battery)	Meaning
3 grids	1 red grid +3 green grids	Full battery
2 grids	1 red grid +2 green grids	Medium battery
1 grid	1 red grid +1 green grid	Low battery
Blank grid	1 red grid	Lower battery, please recharge it.
Blinking		The battery level is going to be used out immediately. And the flash will auto power off in 1 minute. Note: Please recharge the battery as soon as possible (within 10 days). Then, the battery can be used or be placed for long period.

Note: The two indications are almost the same except of grids shift.

Power Management

Long press the <ON/OFF> Power Switch for 2 seconds to control the on/off of the flash unit. Turn off the power pack if the flash unit will not be used for an extended period (approx. 1 hour).

 **C.Fn** Disabling Auto Power Off function is recommended when the flash is used off camera. (C.Fn-APO, Page 44)

Wireless Flash Mode

AD600B can only be set as slave unit (receiver end). Press Wireless Selection Button to switch the two wireless modes: radio transmission and optical transmission. When using radio transmission, AD600B will automatically switch between Canon (C) and Nikon (N) system according to X1 series transmitter. When using optical transmission, please set AD600B to Canon (C) or Nikon (N) before firing a flash.

Wireless Mode	Flash Mode
OFF	M / Multi
Radio Transmission	TTL / M / Multi
Optical Transmission	TTL / M / Multi

Flash Mode — TTL Autoflash

This flash has three flash modes: TTL, Manual (M), and Multi (Stroboscopic). In TTL mode, the camera and the flash will work together to calculate the correct exposure for the subject and the background.

* Press <MODE> Mode Selection Button and three flash modes will display on the LCD panel one by one with each pressing.

TTL Mode

Press <MODE > Mode Selection Button to enter TTL mode. The LCD panel will display <TTL>.

FEC: Flash Exposure Compensation

With FEC function, this flash can adjust from -3 to +3 in 1/3rd stops. It is useful in situations where minor adjusting of the TTL system is needed based on the environment.

Setting FEC:

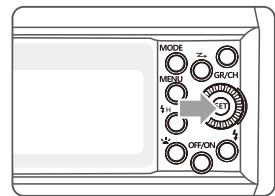

1 Press <SET> Button and flash exposure compensation amount will be highlighted on the LCD panel.

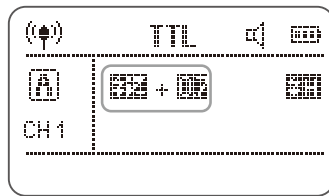

2 Set the flash exposure compensation amount.

- Turn the Select Dial to set the amount.
- "0.3" means 1/3 step, "0.7" means 2/3 step.
- To cancel the flash exposure compensation, set the amount to "+0".

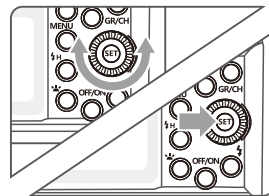

3 Press <SET > button again to confirm the setting.

High-Speed Sync

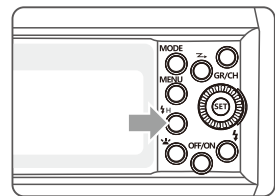

High Speed Sync (FP flash) enables the flash to synchronize with all camera shutter speeds. This is convenient when you want to use aperture priority for fill-flash portraits.

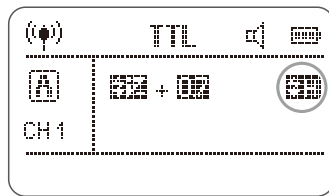

1 Press High Speed Sync Button so that < > is displayed.



2 Please use X1 series transmitter.

- If you set a shutter speed that is the same as or slower than the camera's maximum flash sync speed, < > will not be displayed in the viewfinder.
- With high-speed sync, the faster the shutter speed, the shorter the effective flash range.
- To return to normal flash, press < > button again. Then < > will disappear.
- Multi flash mode cannot be set in high-speed sync mode.
- Over-temperature protection may be activated after 50 consecutive high-speed sync flashes.

Flash Mode — M: Manual Flash

The flash output is adjustable from 1/1 full power to 1/256th power in 1/3rd stop increments. To obtain a correct flash exposure, use a hand-held flash meter to determine the required flash output.

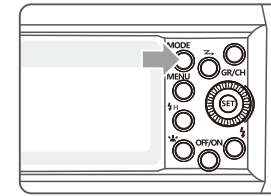

1 Press <MODE > button so that <M > is displayed.

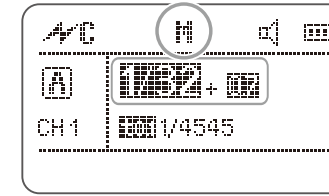

2 Turn the Select Dial to choose a desired flash output amount.

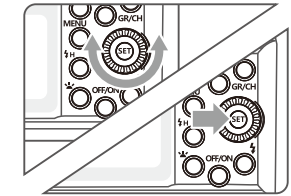

3 Press <SET > button again to confirm the setting.

Flash Output Range

The following table makes it easier to see how the stop changes in terms of f/stop when you increase or decrease the flash output. For example, when you decrease the flash output to 1/2, 1/2-0.3, or 1/2-0.7, and then increase the flash output to more than 1/2, 1/2+0.3, 1/2+0.7, and 1/1 will be displayed.

Figures displayed when reducing flash output level →

1/1	1/1-0.3	1/1-0.7	1/2	1/2-0.3	1/2-0.7	1/4
	1/2+0.7	1/2+0.3		1/4+0.7	1/4+0.3	

← Figures displayed when increasing flash output level

Optical S1 Secondary Unit Setting

In M manual flash mode, press <MENU> button to enter C.FN-SLAVE to choose S1 function, so that this flash can function as an optical S1 secondary flash with optic sensor. With this function, the flash will fire synchronously when the main flash fires, the same effect as that by the use of radio triggers. This helps create multiple lighting effects.

Optical S2 Secondary Unit Setting

Press <MENU > button to enter C.FN-SLAVE to choose S2 function, so that this flash can also function as an optical S2 secondary flash with optical sensor in M manual flash mode. This is useful when cameras have pre-flash function. With this function, the flash will ignore a single "pre-flash" from the main flash and will only fire in response to the second, actual flash from the main unit.

- S1 and S2 optical triggering is only available in M manual flash mode.

Flash Mode — M: Manual Flash

Display Flash Duration

Flash duration refers to the length of time that from flash's firing to reach the half peak at maximum. The half peak at maximum is usually expressed as $t=0.5$. In order to provide the photographer with more concrete data, this product adopts $t=0.1$. The difference between $t=0.5$ and $t=0.1$ is shown in the following picture.

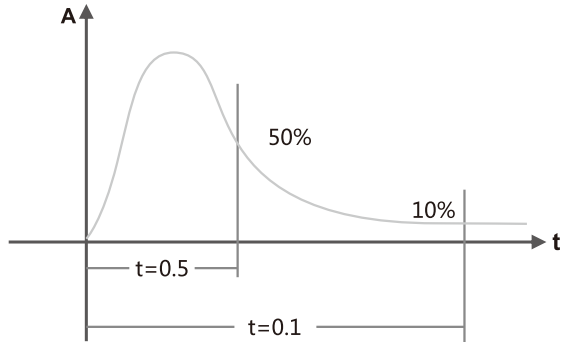

The flash duration will only be displayed on the LCD panel in M mode.

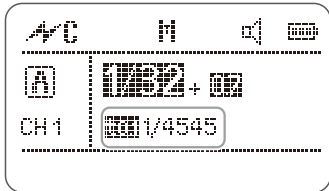

Flash Mode — Multi: Stroboscopic Flash

With stroboscopic flash, a rapid series of flashes is fired. It can be used to capture a multiple images of a moving subject in a single photograph. You can set the firing frequency (number of flashes per sec. expressed as Hz), the number of flashes, and the flash output.

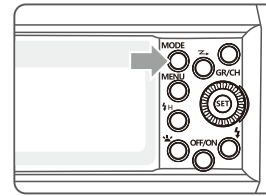

1 Press <MODE> button so that <MULTI> is displayed.

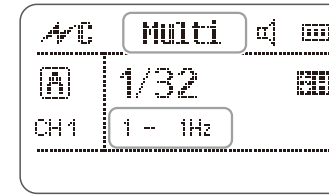

2 Turn the Select Dial to choose a desired flash output.

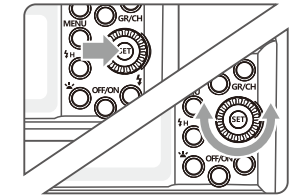

3 Set the flash frequency and flash times.

- Press <SET> Button to select the flash times. Turn the Select Dial to set the number.
- Press <SET> Button to select the flash frequency. Turn the Select Dial to set the number.
- After you finish the setting, press <SET> button and all the settings will be displayed.

Calculating the Shutter Speed

During stroboscopic flash, the shutter remains open until the firing stops. Use the formula below to calculate the shutter speed and set it with the camera.

$$\text{Number of Flashes} / \text{Flash Frequency} = \text{Shutter Speed}$$

For example, if the number of flashes is 10 and the firing frequency is 5 Hz, the shutter speed should be at least 2 seconds.

⚠ To avoid overheating and deteriorating the flash head, do not use stroboscopic flash more than 10 times in succession. After 10 times, allow the camera flash to rest for at least 15 minutes. If you try to use the stroboscopic flash more than 10 times in succession, the firing might stop automatically to protect the flash head. If this happens, allow at least 15 minutes' rest for the camera flash.

- Stroboscopic flash is most effective with a highly reflective subject against a dark background.
- Using a tripod and a remote control is recommended.
- A flash output of 1/1 and 1/2 cannot be set for stroboscopic flash.
- Stroboscopic flash can be used with "buLb".
- If the number of flashes is displayed as "-", the firing will continue until the shutter closes or the battery is exhausted. The number of flashes will be limited as shown by the following table.

Maximum Stroboscopic Flashes:

Flash Output \ Hz	1	2	3	4	5	6-7	8-9	10	11	12-14	15-19	20-50	60-100
1/4	7	6	5	4	4	3	3	2	2	2	2	2	2
1/8	14	14	12	10	8	6	5	4	4	4	4	4	4
1/16	30	30	30	20	20	20	10	8	8	8	8	8	8
1/32	60	60	60	50	50	40	30	20	20	20	18	16	12
1/64	90	90	90	80	80	70	60	50	40	40	35	30	20
1/128	100	100	100	100	100	90	80	70	70	60	50	40	40
1/256	100	100	100	100	100	90	80	70	70	60	50	40	40

Wireless Flash Shooting: Radio (2.4G) Transmission

AD600B adopts Godox 2.4G wireless X system, which has good compatibility with other products of our company. As a slave unit, AD600B is automatically compatible with Canon E-TTL II system and Nikon i-TTL system according to the master unit. When receiving the master unit's signal, "C" or "N" will be displayed on the LCD panel. Nikon cameras (use X1T-N, TT685N, etc.) and Canon cameras (use X1T-C, TT685C, etc.) can use one or more AD600B flashes simultaneously.

*As a slave unit, AD600B can be controlled by the following master units: AD360II-C, AD360II-N, TT685C, TT685N, X1T-C, X1T-N, TT600, etc.

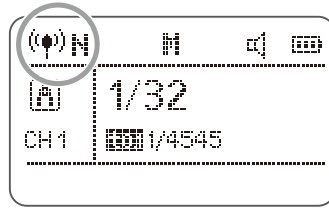
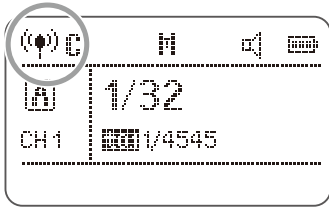

1. Wireless Settings

Press <Z> Wireless Setting Button again until <(P)> is displayed on the panel.

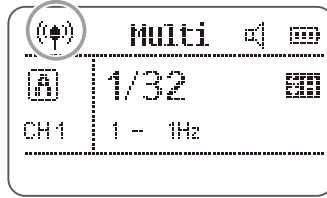
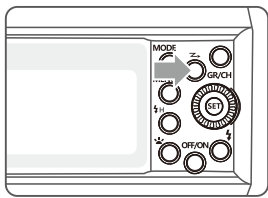

2. Setting the Communication Channel

If there are other wireless flash systems nearby, you can change the channel IDs to prevent signal interference. The channel IDs of the master unit and the slave unit(s) must be set to the same.

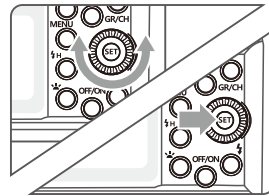
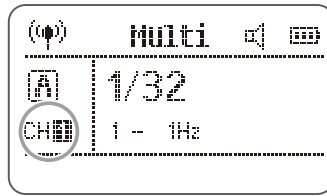
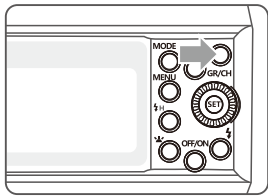

1 Long press the <GR/CH> Button for 2 seconds so that channels ID is displayed on the LCD panel.

2 Turn the Select Dial to choose a channel ID from 1 to 32.

3 Press the <SET> button to confirm.

Wireless Flash Shooting: Radio (2.4G) Transmission

3. Setting the Communication Group

Short press the <GR/CH> Button to choose group ID from A to E.

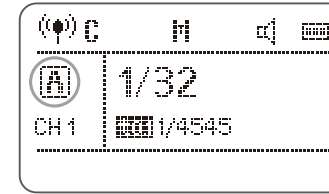
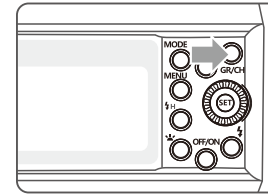

4. Wireless Flash Shooting

Positioning and Operation Range (Example of wireless flash shooting)

- Autoflash Shooting with One Slave Unit

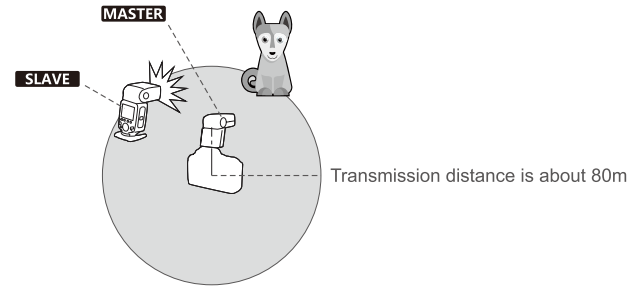

- Use the supplied mini stand to position the slave unit.
- Before shooting, perform a test flash and test shooting.
- The transmission distance might be shorter depending on the conditions such as positioning of slave units, the surrounding environment and whether conditions.

Wireless Flash Shooting: Radio (2.4G) Transmission

Wireless Multiple Flash Shooting

You can divide the slave units into two or three groups and perform TTL autoflash while changing the flash ratio (factor). In addition, you can set and shoot with a different flash mode for each firing group.

- Auto Shooting with Two Slave Groups

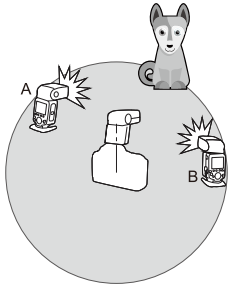

- Auto Shooting with Three Slave Groups

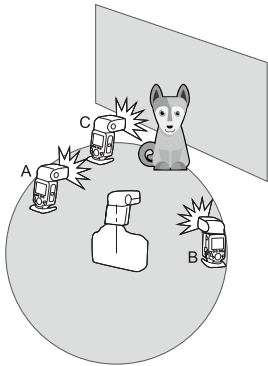

Wireless shooting using radio transmission has advantages over wireless shooting using optic transmission, such as being less affected by obstacles, and not having to point the slave unit's wireless sensor toward the master unit.

The main functional differences are as follows:

Function	Radio Transmission	Optical Transmission
Distance	80m (X1 series transmitter)	Approx. 10m
Channel	1~32	1~4
Group	A/B/C/D/E	A/B/C
To be disturbed	Hard	Easy

Wireless Flash: Optical Transmission

AD600B supports wireless flash functions and can be set as slave unit. Choose Canon or Nikon optical wireless system through C. FN-REMOTE on the MENU list.

* Compatible Canon optical wireless system: AD600B can receive wireless signals of Canon speedlites e.g. 580EXII, 600EX-RT and commanders of Canon cameras e.g. 7D/60D/600D.

* Compatible Nikon optical wireless system: AD600B can receive wireless signals of Nikon speedlights e.g. SB-900, SB-910 and commanders of D7100/D7000/D800.

- You can set up one to five slave groups for TTL autoflash shooting. With TTL autoflash, you can easily create various lighting effects.
- Any flash settings (of flash exposure compensation, high-speed sync, FE lock, FEB, manual flash, Multi flash) on the master unit will be automatically sent to the slave units. So the only thing you need to do is to set the master unit to TTL mode without any operation for the slave units at all during the shooting.
- This flash can work in TTL autoflash, M manual flash, and Multi stroboscopic flash modes when set as a master unit.

Positioning and Operation Range

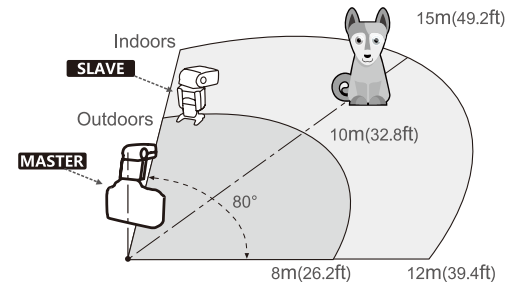

1. Wireless Settings

Press < Z > Wireless Setting Button again until < ⚡ > is displayed on the panel.

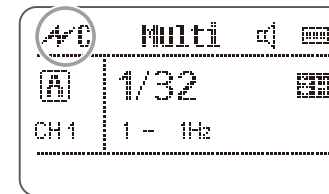
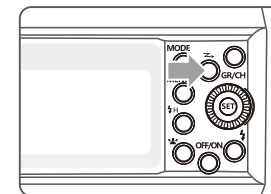

Wireless Flash: Optical Transmission

2. Setting the Communication Channel

If there are other wireless flash systems nearby, you can change the channel IDs to prevent signal interference. The channel IDs of the master unit and the slave unit(s) must be set to the same.

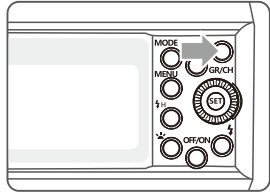

1 Long press the <GR/CH> Button for 2 seconds so that channels ID is displayed on the LCD panel.

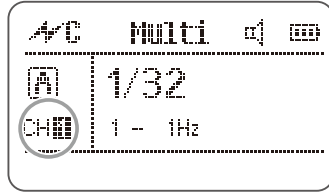

2 Turn the Select Dial to choose a channel ID from 1 to 4.

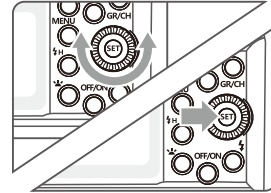

3 Press the <SET> button to confirm.

3. Setting the Communication Group

Short press the < GR/CH > Button to choose group ID from A to C.

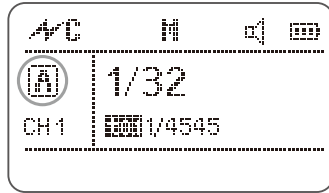
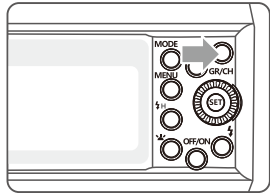

⚠ The slave unit might be out of order or fire an unwanted flash due to the nearby fluorescent lamp or computer screen.

Warning

Operating frequency:2412.99MHz-2464.49MHz(only receive)

Declaration of Conformity

GODOX Photo Equipment Co.,Ltd. hereby declares that this equipment are in compliance with the essential requirements and other relevant provisions of Directive 2014/53/EU. In accordance with Article 10(2) and Article 10(10), this product is allowed to be used in all EU member states.For more information of DoC, Please click this web link:

https://www.godox.com/DOC/Godox_AD600_Series_DOC.pdf

The device complies with RF specifications when the device used at 0mm from your body.

C.Fn: Setting Custom Functions

Custom Function Signs	Functions	Setting Signs	Settings & Descriptions	Restrictions
BEEP	Beeper	ON	ON	NO
		OFF	OFF	
SLAVE	S1/S2 mode selection	OFF	OFF	M mode
		S1	S1 mode	
		S2	S2 mode	
FAN	Fan working mode	OFF	OFF	NO
		AUTO	Temperature <45°: OFF	
			Temperature >45°: LOW FAN	
	Temperature >60°: HIGH FAN			
SLEEP	Auto power off	OFF	OFF	NO
		1HR	Auto power off without any operation	
		2HR		
		3HR		
LIGHT	Backlighting time	12sec	Off in 12 sec.	NO
		OFF	Always off	
		ON	Always lighting	
DELAY	Delay flash	OFF, 0.01~30S	Can be triggered as second curtain	M/Multi mode
UNITS	Total number of flashes	2~4	Use UNITS in combination with ALT: UNITS sets the total	M mode
ALT	Triggering times		number of flashes; ALT sets the triggering times before flash's firing	M mode
LCD	LCD contrast	0~9	10 levels	
REMOTE	Optical wireless remote system	CANON	Canon	Optical wireless mode
		NIKON	Nikon	
RESET	Parameter resetting	NO		NO
		YES	Reseting	

1. Press < MENU > Button to enter C.Fn menu. The "Ver x.x" in the top-right corner refers to the software version.

2. Select the Custom Function Signs.

* Turn the Select Dial to select the Custom Function Signs.

Modeling Lamp

3. Change the Setting.

* Press<SET> button and the Setting Signs are highlighted.

* Turn the Select Dial to set the desired number. Press <SET> button will confirm the settings.

4. Exit C.Fn Menu.

* Press <MENU> Button to exit.

Modeling Lamp

AD600B is equipped with a 10W LED modeling lamp which has 3 steps of light adjustment and two always lighting modes.

• **Short press the Modeling Lamp Button to set the steps:**

One step: 30% of power output; off in 30 minutes (prevent overheating)

Two step: 60% of power output; off in 20 minutes (prevent overheating)

Three step: 100% of power output; off in 10 minutes (prevent overheating)

• **Long press the modeling lamp for 2 seconds to set modeling modes:**

1.Always lighting

2.Modeling lamp auto off when firing.

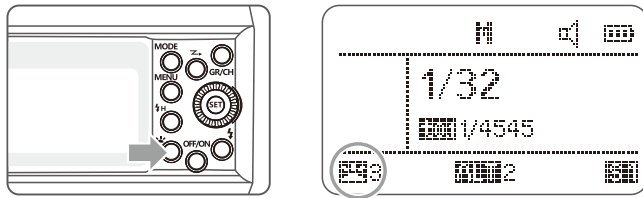

Other Applications

Wireless Control Function

The flash unit is built in with a Wireless Control Port so that you can wirelessly adjust the power level of the flash and the flash triggering.

To control the flash wirelessly, you need a FT-16 remote control set (on-camera and on-flash). Insert its receive end into the Wireless Control Port on the flash and insert the transmit end into the camera hot shoe. Settings made on the hotshoe-mounted transmit and receive ends will be wirelessly communicated to the flash. Then you can press the camera shutter release button to trigger the flash. You can also hold the transmit end at hand to control your off-camera flash.

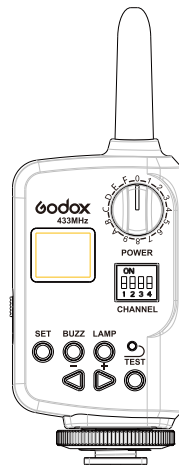

For full instructions on the use of FT series remote control, see its user manual.

Sync Triggering

The Sync Cord Jack is a $\Phi 3.5\text{mm}$ plug. Insert a trigger plug here and the flash will be fired synchronously with the camera shutter.

Protection Function

1. Over-Temperature Protection

- To avoid overheating and deteriorating the flash head, do not fire more than 100 continuous flashes in fast succession at 1/1 full power. After 100 continuous flashes, allow a rest time of at least 10 minutes.
- If you fire more than 100 continuous flashes and then fire more flashes in short intervals, the inner over-temperature protection function may be activated and make the recycling time over 10 seconds. If this occurs, allow a rest time of about 10 minutes, and the flash unit will then return to normal.
- When the over-temperature protection is started, **!!!** is shown on the LCD display.

Number of flashes that will activate over-temperature protection:

Power Output Level	Number of Flashes
1/1	100
1/2 (+0.3,+0.7)	150
1/4 (+0.3,+0.7)	200
1/8 (+0.3,+0.7)	300
1/16 (+0.3,+0.7)	400
1/32 (+0.3,+0.7)	500
1/64 (+0.3,+0.7)	1000
1/128 (+0.3,+0.7)	
1/256 (+0.3,+0.7)	

Number of flashes that will activate over-temperature protection in high-speed sync triggering mode:

Power Output	Times
1/1	50
1/2 (+0.3,+0.7)	60
1/4 (+0.3,+0.7)	75
1/8 (+0.3,+0.7)	100
1/16 (+0.3,+0.7)	150
1/32 (+0.3,+0.7)	200
1/64 (+0.3,+0.7)	300
1/128 (+0.3,+0.7)	
1/256 (+0.3,+0.7)	

2. Other Protections

- The system provides real-time protection to secure the device and your safety. The following lists prompts for your reference:

LCD Panel	Meaning
E1	A failure occurs on the recycling system so that the flash cannot fire. Please restart the flash unit. If the problem still exists, please send this product to a maintenance center.
E2	The system gets excessive heat. Please allow a rest time of 10 minutes.
E3	The voltage on two outlets of the flash tube is too high. Please send this product to a maintenance center.
E9	There are some errors occurred during the upgrading process. Please using the correct firmware upgrade method.

Technical Data

Model	AD600B	
Wireless Slave Unit Mode	Radio transmission mode (compatible with Nikon & Canon) Optical transmission mode (compatible with Nikon & Canon)	
Flash Mode	Wireless off	M/Multi
	Slave unit of radio transmission	TTL/M/Multi
	Slave unit of optical transmission	TTL/M/Multi
Compatible Cameras under Radio Transmission (as slave unit)	Nikon cameras, supporting i-TTL/M/RPT flash (X1N as master unit, etc.) Canon EOS cameras, supporting E-TTL II/M/RPT flash (X1C as master unit, etc.)	
Guide No. (m ISO 100)	87 (m ISO 100, with AD-R7 standard reflector)	
Flash Duration	1/220 to 1/10000 seconds (T0.1)	
POWER	600W	
Power Output	9 steps: 1/256~1/1	
Stroboscopic Flash	Provided (up to 100 times, 100Hz)	
Flash Exposure Compensation (FEC)	Manual. Feb: ±3 stops in 1/3 stop increments.	
Sync mode	High-speed sync (up to 1/8000 seconds), first-curtain sync, and second-curtain sync	
Delay Flash	0.01~30 Seconds	
Mask	√	
Fan	√	
Beeper	√	
Modeling Lamp (LED)	10W	
Optical Slave Flash	S1/S2	
Flash Duration Indication	√	
Display	Dot-matrix panel	
• Wireless Flash (optical transmission and 2.4G transmission)		
Wireless Flash Function	Slave, Off	
Controllable Slave Groups	Optical	3 (A, B, C)
	2.4G	5 (A, B, C, D, E)
Transmission Range (approx.)	Optical	Indoors: 12 to 15 m / 39.4 to 49.2 ft. Outdoors: 8 to 10 m / 26.2 to 32.8 ft.
	2.4G	80m
Channels	Optical	4 (1, 2, 3, and 4)
	2.4G	32 (1~32)
• Power Supply		
Power Supply	Lithium battery pack (11.1V/8700mAh)	
Full Power Flashes	500	
Recycle Time	Approx. 0.01-2.5s	
Battery Indicator	√	
Power Indication	Power off automatically after approx. 60 minutes of idle operation.	
• Sync Triggering Mode	3.5mm sync line, wireless control port	
• Color Temperature	5600±200k	
• Dimensions		
Dimension (with battery)	220x245x125 mm (flash tube & reflector not included)	
Net Weight (with battery)	2.69 Kg (flash tube & reflector not included)	

Troubleshooting

If there is a problem, refer to this Troubleshooting Guide.

The flash exposure is underexposed or overexposed.

- There was a highly reflective object (e.g. glass window) in the picture.
→Use FE lock (FEL).
- You used high-speed sync.
→With high-speed sync, the effective flash range will be shorter. Make sure the subject is within the effective flash range displayed.
- You used Manual Flash mode.
→Set the flash mode to TTL or modify the flash output.

Firmware Upgrade

This flash supports firmware upgrade through the USB port. Update information will be released on our official website.

 USB connection line is not included in this product. The USB port is a standard Micro USB socket. Common USB connection line is applicable.

Maintenance

- Shut down the device immediately should abnormal operation be detected.
- Avoid sudden impacts and the product should be dedusted regularly.
- It is normal for the flash tube to be warm when in use. Avoid continuous flashes if unnecessary.
- Maintenance of the flash must be performed by our authorized maintenance department which can provide original accessories.
- This product, except consumables e.g. flash tube, is supported with a one-year warranty.
- Unauthorized service will void the warranty.
- If the product had failures or was wetted, do not use it until it is repaired by professionals.
- Changes made to the specifications or designs may not be reflected in this manual.